

Data sheet | Item number: 873-902

Luminaire disconnect connector; 2-pole; 4,00 mm²; yellow

www.wago.com/873-902

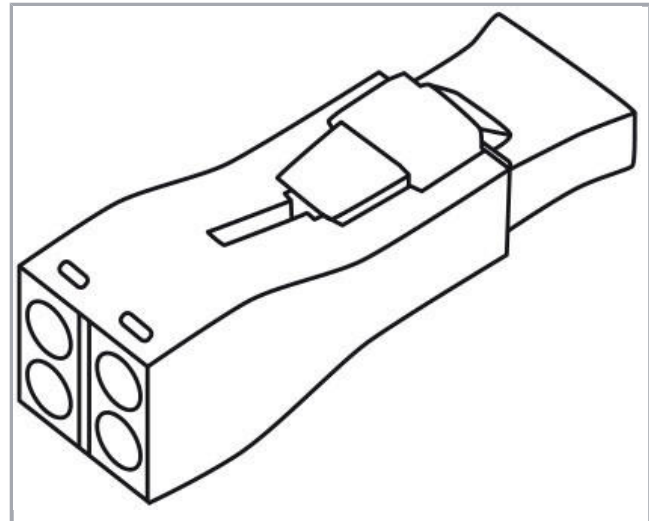
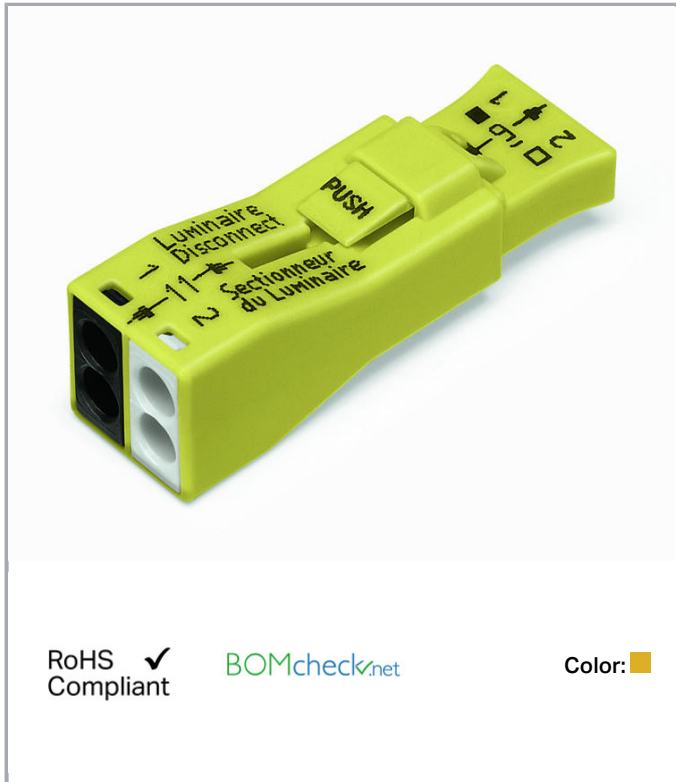

RoHS
Compliant

BOMcheck.net

Color:

Data

Electrical data

Ratings per IEC/EN 60664-1

Ratings per	EN 60998
Rated voltage (II / 2)	400 V
Rated impulse voltage (II / 2)	4 kV
Rated current	6 A
Ratings according to 2	EN 61984

Connection data

Connection type (1)	Plug
Connection technology	PUSH WIRE®

Subject to changes. Please also observe the further product documentation!

WAGO Kontakttechnik GmbH & Co. KG
Hansastr. 27
32423 Minden
Phone: +49571 887-0 | Fax: +49571 887-169
Email: info.de@wago.com | Web: www.wago.com

Do you have any questions about our products?
We are always happy to take your call at +49 (571) 887-44222.

Actuation type	Push-in
Connectable conductor materials	Copper
Solid conductor	0,75 ... 4 mm ² / 18 ... 12 AWG
Stranded conductor	1,5 ... 2,5 mm ² / 16 ... 12 AWG
Strip length	11 ... 13 mm / 0.43 ... 0.51 inch
No. of poles	2
Connection type (2)	Socket
Solid conductor (2)	0,75 mm ² / 18 AWG
Strip length (2)	9 ... 11 mm / 0.35 ... 0.43 inch
Total number of connection points	6
Total number of potentials	2

Geometrical Data

Width	13 mm / 0.512 inch
Height	13,2 mm / 0.52 inch
Depth	42 mm / 1.654 inch

Material Data

Color	yellow
Fire load	0.103 MJ
Weight	4.8 g

Commercial data

Product Group	8 (Misc. Chassis Mount Blocks)
Packaging type	BOX
Country of origin	CN
GTIN	4045454548421
Customs Tariff No.	85366990990

Approvals / Certificates

Country specific Approvals





Logo	Approval	Additional Approval Text	Certificate name
	CCA DEKRA Certification B.V.	EN 61984	2178521.01

Subject to changes. Please also observe the further product documentation!

WAGO Kontakttechnik GmbH & Co. KG
 Hansastr. 27
 32423 Minden
 Phone: +49571 887-0 | Fax: +49571 887-169
 Email: info.de@wago.com | Web: www.wago.com

Do you have any questions about our products?
 We are always happy to take your call at +49 (571) 887-44222.



	CCA DEKRA Certification B.V.	EN 61984	NTR NL-7390
	CCA DEKRA Certification B.V.	EN 60998	NTR NL-7391
	CCA DEKRA Certification B.V.	EN 60998	2178521.02
	CSA DEKRA Certification B.V.	C22.2 No. 182.3	154112 (LR 18677)

UL-Approvals

Logo	Approval	Additional Approval Text	Certificate name
	UL UL International Germany GmbH	UL 2459	E313353

Counterpart

Downloads

Documentation

Bid Text

873-902 GAEB X81 - Datei	Feb 19, 2019	xml 3.2 kB	Download
873-902 GAEB docx - Datei	Feb 21, 2019	docx 15.1 kB	Download
Additional Information Technical explanations	Apr 3, 2019	pdf 2.1 MB	Download

Subject to changes. Please also observe the further product documentation!

WAGO Kontakttechnik GmbH & Co. KG
 Hansastr. 27
 32423 Minden
 Phone: +49571 887-0 | Fax: +49571 887-169
 Email: info.de@wago.com | Web: www.wago.com

Do you have any questions about our products?
 We are always happy to take your call at +49 (571) 887-44222.



CAD/CAE-Data

CAD data

2D/3D Models 873-902

URL

Download

Installation Notes

Subject to changes. Please also observe the further product documentation!

WAGO Kontakttechnik GmbH & Co. KG
Hansastr. 27
32423 Minden
Phone: +49571 887-0 | Fax: +49571 887-169
Email: info.de@wago.com | Web: www.wago.com

Do you have any questions about our products?
We are always happy to take your call at +49 (571) 887-44222.