



MATE-N-LOK | Mini-Universal MATE-N-LOK 2

TE Internal #: 794219-1

Power Contacts, Contact, 600 VAC, 600 VDC, Pre-Tin, 26 – 22 AWG

Wire Size, .12 – .4 mm<sup>2</sup> Wire Size, Wire-to-Wire, Mini-Universal

MATE-N-LOK 2

[View on TE.com >](#)

Connectors > Power Connectors > Power Contacts



Power Contact Type: **Contact**

Operating Voltage: **600 VDC**

Contact Mating Area Plating Material: **Pre-Tin**

Wire Size: **26 – 22 AWG**

**Features**

**Product Type Features**

Power Contact Type	Contact
Connector System	Wire-to-Wire
Connector & Contact Terminates To	Wire & Cable

**Electrical Characteristics**

Operating Voltage	600 VDC
-------------------	---------

**Contact Features**

Contact Mating Area Plating Material	Pre-Tin
Contact Current Rating (Max)	10.5 A
Contact Type	Socket
Contact Retention Within Housing	Without
Mating Pin Diameter	1 mm [.039 in]
Contact Base Material	Brass
Wire Contact Termination Area Plating Thickness	2.54 µm [100 µin]
Wire Contact Termination Area Plating Material	Pre-Tin
Wire Contact Termination Area Plating Material Finish	Bright

Contact Orientation	Straight
---------------------	----------

### Termination Features

Termination Method to Wire & Cable	Crimp
------------------------------------	-------

### Mechanical Attachment

Connector Mounting Type	Cable Mount (Free-Hanging)
-------------------------	----------------------------

Wire Insulation Support	Without
-------------------------	---------

### Dimensions

Wire Size	.12 – .4 mm <sup>2</sup>
-----------	--------------------------

Accepts Wire Insulation Diameter Range	1.19 – 1.75 mm [.047 – .069 in]
--	---------------------------------

### Usage Conditions

Operating Temperature Range	-55 – 105 °C [-67 – 221 °F]
-----------------------------	-----------------------------

### Operation/Application

Circuit Application	Power
---------------------	-------

### Industry Standards

Glow Wire Rating	Standard Part - Not Glow Wire
------------------	-------------------------------

VDE Tested	No
------------	----

Agency/Standard	UL
-----------------	----

UL Rating	Recognized
-----------	------------

UL Flammability Rating	UL 94V-0, UL 94V-2
------------------------	--------------------

UL File Number	E28476
----------------	--------

### Packaging Features

Packaging Method	Reel
------------------	------

Packaging Quantity	7000
--------------------	------

### Other

Wire/Cable Type	Discrete Wire
-----------------	---------------

Wire Type	Stranded
-----------	----------

For Use With	Plug Housing
--------------	--------------

### Product Compliance

For compliance documentation, visit the product page on [TE.com](https://www.te.com)>

EU RoHS Directive 2011/65/EU	Compliant
------------------------------	-----------

EU ELV Directive 2000/53/EC

Compliant

China RoHS 2 Directive MIIT Order No 32, 2016

No Restricted Materials Above Threshold

EU REACH Regulation (EC) No. 1907/2006

Current ECHA Candidate List: JUNE 2022 (224)

Candidate List Declared Against: JAN 2022 (223)

SVHC > Threshold:  
Not Yet Reviewed

Halogen Content

Low Halogen - Br, Cl, F, I < 900 ppm per homogenous material. Also BFR/CFR/PVC Free

Solder Process Capability

Not applicable for solder process capability

Product Compliance Disclaimer

This information is provided based on reasonable inquiry of our suppliers and represents our current actual knowledge based on the information they provided. This information is subject to change. The part numbers that TE has identified as EU RoHS compliant have a maximum concentration of 0.1% by weight in homogenous materials for lead, hexavalent chromium, mercury, PBB, PBDE, DBP, BBP, DEHP, DIBP, and 0.01% for cadmium, or qualify for an exemption to these limits as defined in the Annexes of Directive 2011/65/EU (RoHS2). Finished electrical and electronic equipment products will be CE marked as required by Directive 2011/65/EU. Components may not be CE marked. Additionally, the part numbers that TE has identified as EU ELV compliant have a maximum concentration of 0.1% by weight in homogenous materials for lead, hexavalent chromium, and mercury, and 0.01% for cadmium, or qualify for an exemption to these limits as defined in the Annexes of Directive 2000/53/EC (ELV). Regarding the REACH Regulation, the information TE provides on SVHC in articles for this part number is based on the latest European Chemicals Agency (ECHA) 'Guidance on requirements for substances in articles' posted at this URL: <https://echa.europa.eu/guidance-documents/guidance-on-reach>

## Compatible Parts

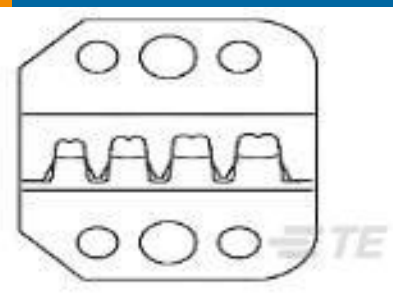

TE Part # 90758-2  
PROCRIMP DIE MINI UNIV MNL



TE Part # 189727-1  
EXTRACTION TOOL



TE Part # 455830-1  
INSERTION TOOL



TE Part # 794215-1  
24P MINI UMNL2 CAP HSG UL94V0



TE Part # 794200-1  
12P MINI UMNL2 PLUG HSG MATRIX



TE Part # 794210-1  
20P MINI UMNL2 PLUG HSG UL94V0

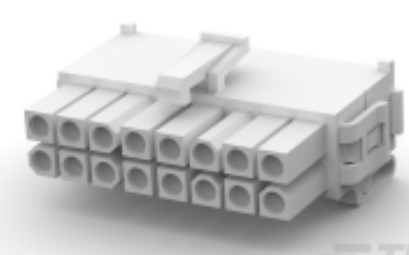

TE Part # 794206-1  
16P MINI UMNL2 PLUG HSG UL94V0



TE Part # 794194-1  
09P MINI UMNL2 PLUG HSG UL94V0



## Also in the Series | Mini-Universal MATE-N-LOK 2

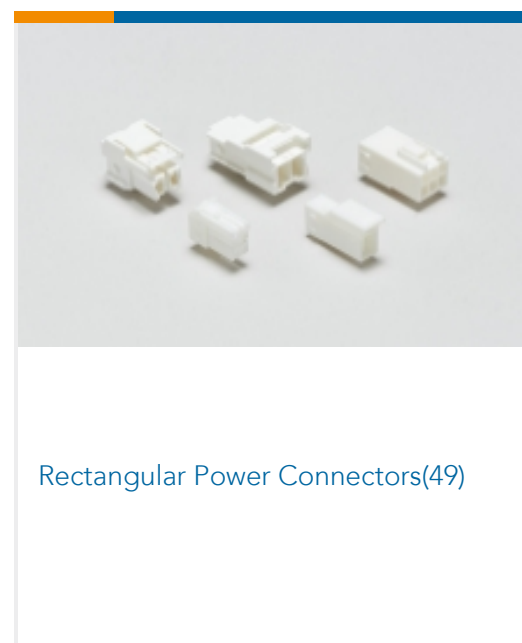
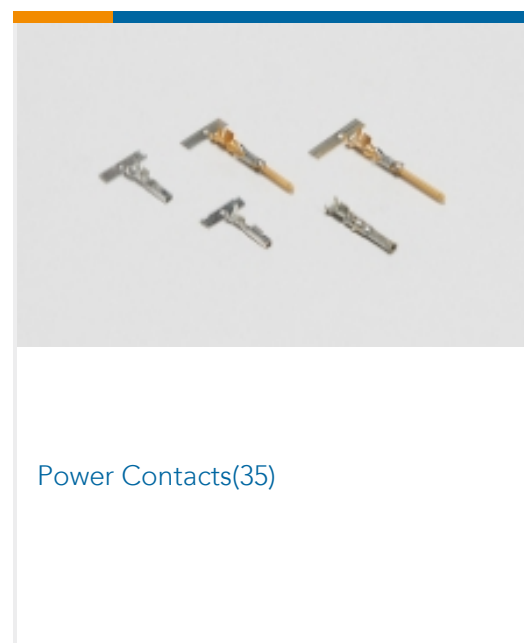
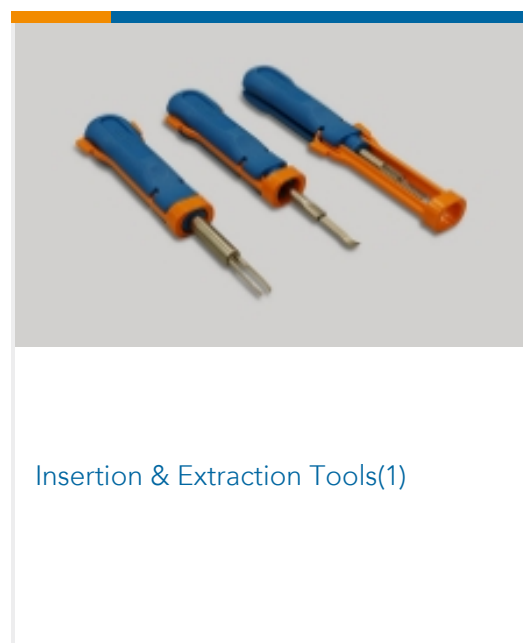
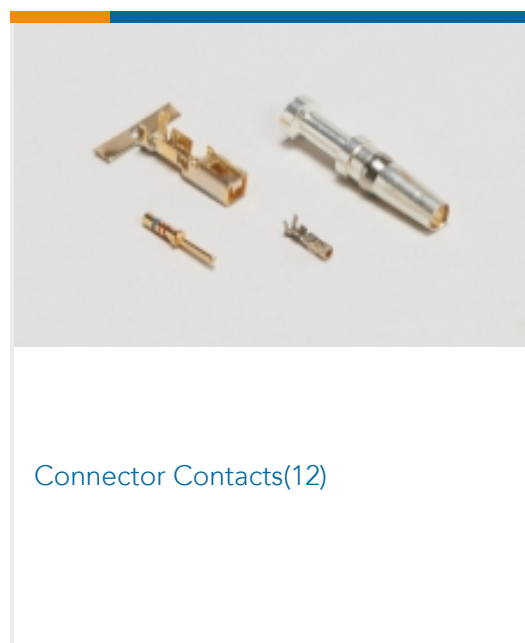

## Customers Also Bought

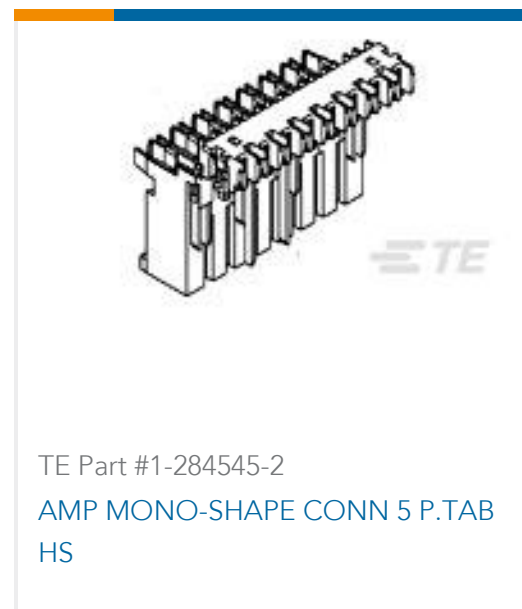

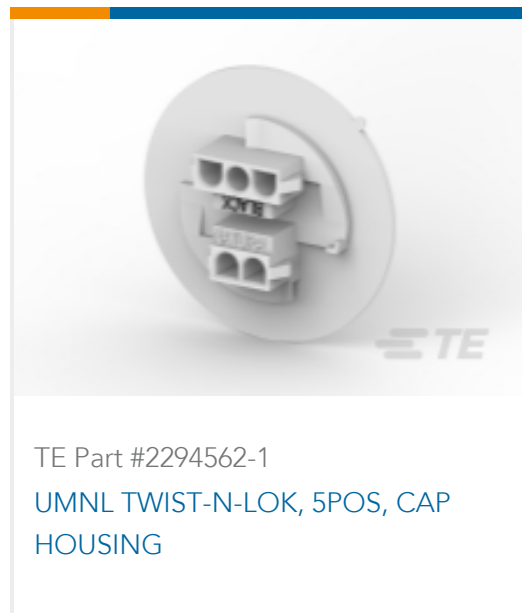

## Documents

### CAD Files

#### 3D PDF

3D

#### Customer View Model

[ENG\\_CVM\\_CVM\\_794219-1\\_N.2d\\_dxf.zip](#)

English

#### Customer View Model

[ENG\\_CVM\\_CVM\\_794219-1\\_N.3d\\_igs.zip](#)

English

#### Customer View Model

[ENG\\_CVM\\_CVM\\_794219-1\\_N.3d\\_stp.zip](#)

English

By downloading the CAD file I accept and agree to the [Terms and Conditions](#) of use.

### Datasheets & Catalog Pages

[SOFT\\_SHELL\\_PIN\\_AND\\_SOCKET\\_CONNECTORS\\_CATALOG](#)

English

### Product Specifications

[Engineering Report](#)

English

### Product Environmental Compliance

[MD\\_794219-1\\_03162016244\\_dmtec](#)

English

[MD\\_794219-1\\_03162016244\\_dmtec](#)

English

