

796381-2 ✓ ACTIVE

AMP | AMP CPC

TE Internal #: 796381-2

Unscreened Circular Connector Backshells & Clamps, Cable Clamp,
Size 17, Right Angle, Individual, 15/16-20 UNEF-2B, AMP CPC

[View on TE.com >](#)



Connectors > Circular Connectors > Circular Connector Accessories > Unscreened Circular Connector Backshells & Clamps > CPC CABLE CLAMPS



Backshell & Clamp Accessory Type: **Cable Clamp**

Compatible With Circular Connector Shell Size: **17**

Body Orientation: **Right Angle**

Accepts Cable Diameter (Max): **11.51 mm [.453 in]**

Protective Cover: **Without**

[All CPC CABLE CLAMPS \(25\)](#)

Features

Product Type Features

Product Type	Accessory
Backshell & Clamp Accessory Type	Cable Clamp
Protective Cover	Without

Body Features

Cable Clamp Material	Nylon
Cable Clamp Flammability Rating	UL 94V-0
Cable Clamp Color	Black

Mechanical Attachment

Screw Size	5-20
Screw Type	Self-Tapping
Screw & Hole Thread Size	15/16-20 UNEF-2B

Housing Features

Body Orientation	Right Angle
------------------	-------------



Dimensions

Accepts Cable Diameter (Max)	11.51 mm[.453 in]
------------------------------	-------------------

Operation/Application

Compatible With Circular Connector Shell Size	17
---	----

Packaging Features

Packaging Quantity	1
Packaging Method	Individual

Product Compliance

[For compliance documentation, visit the product page on TE.com>](#)

EU RoHS Directive 2011/65/EU	Compliant
EU ELV Directive 2000/53/EC	Compliant
China RoHS 2 Directive MIIT Order No 32, 2016	No Restricted Materials Above Threshold
EU REACH Regulation (EC) No. 1907/2006	Current ECHA Candidate List: JUNE 2022 (224) Candidate List Declared Against: JUNE 2022 (224) Does not contain REACH SVHC
Halogen Content	Not Low Halogen - contains Br or Cl > 900 ppm.
Solder Process Capability	Not applicable for solder process capability

Product Compliance Disclaimer

This information is provided based on reasonable inquiry of our suppliers and represents our current actual knowledge based on the information they provided. This information is subject to change. The part numbers that TE has identified as EU RoHS compliant have a maximum concentration of 0.1% by weight in homogenous materials for lead, hexavalent chromium, mercury, PBB, PBDE, DBP, BBP, DEHP, DIBP, and 0.01% for cadmium, or qualify for an exemption to these limits as defined in the Annexes of Directive 2011/65/EU (RoHS2). Finished electrical and electronic equipment products will be CE marked as required by Directive 2011/65/EU. Components may not be CE marked. Additionally, the part numbers that TE has identified as EU ELV compliant have a maximum concentration of 0.1% by weight in homogenous materials for lead, hexavalent chromium, and mercury, and 0.01% for cadmium, or qualify for an exemption to these limits as defined in the Annexes of Directive 2000/53/EC (ELV). Regarding the REACH Regulation, the information TE provides on SVHC in articles for this part number is based on the latest European Chemicals Agency (ECHA) 'Guidance on requirements for substances in articles' posted at this URL: <https://echa.europa.eu/guidance-documents/guidance-on-reach>

Compatible Parts



Also in the Series | AMP CPC

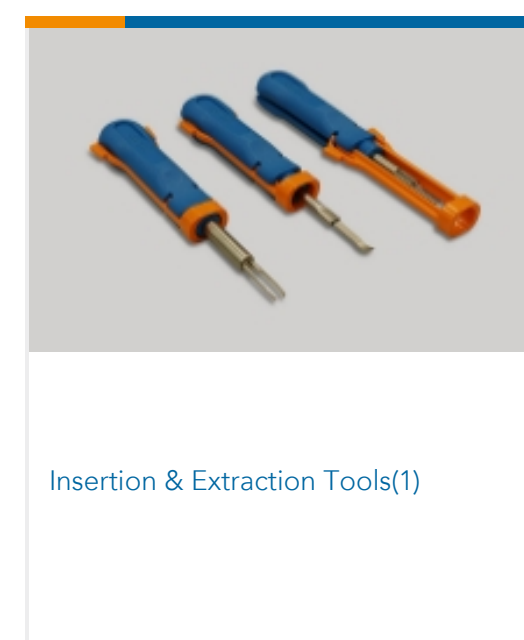
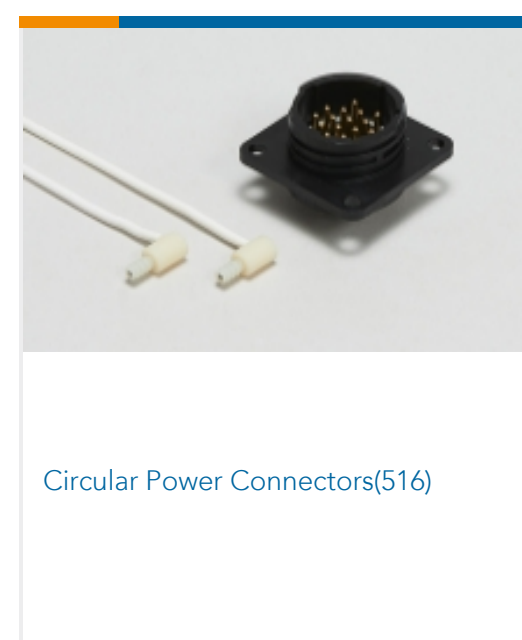
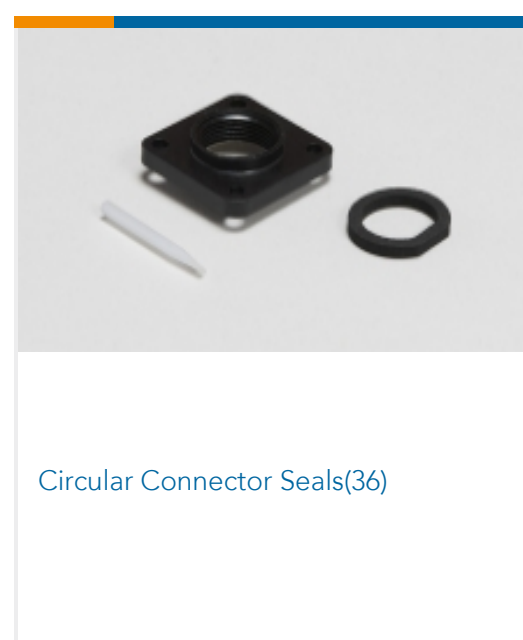
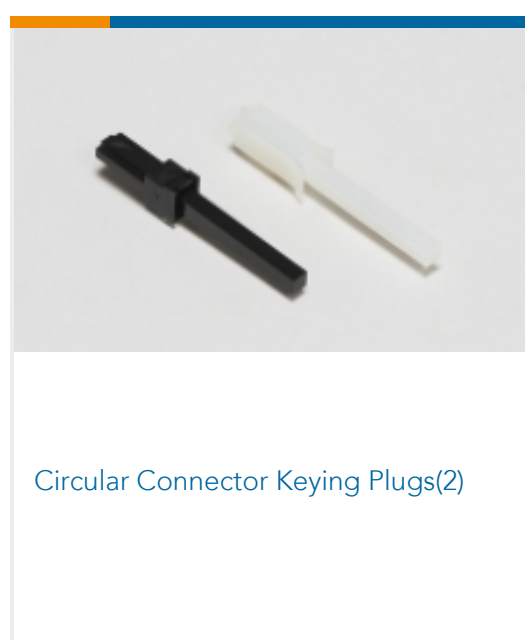
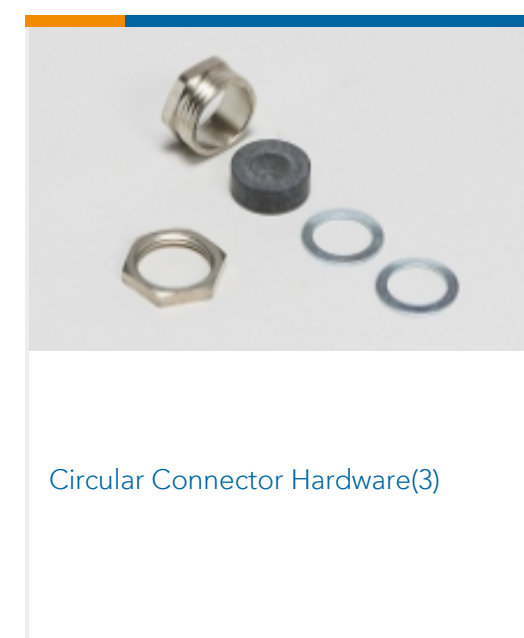
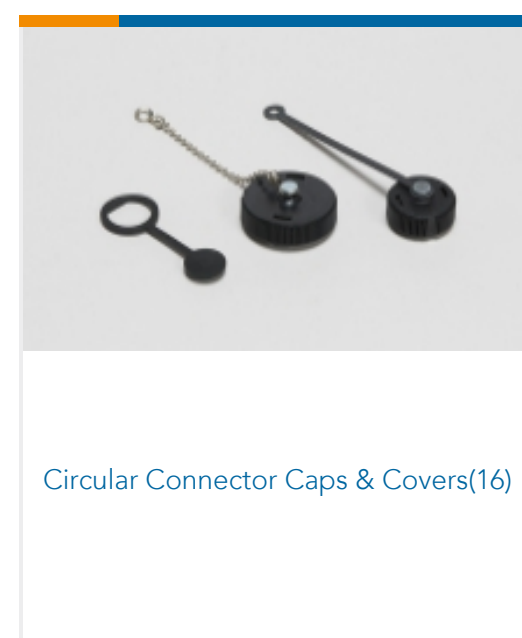
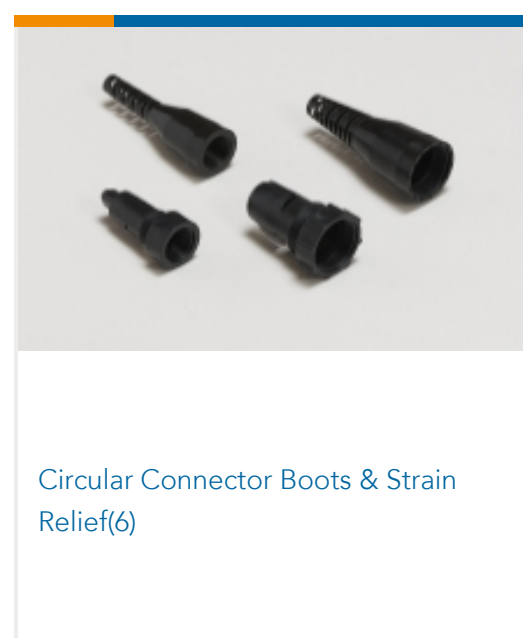
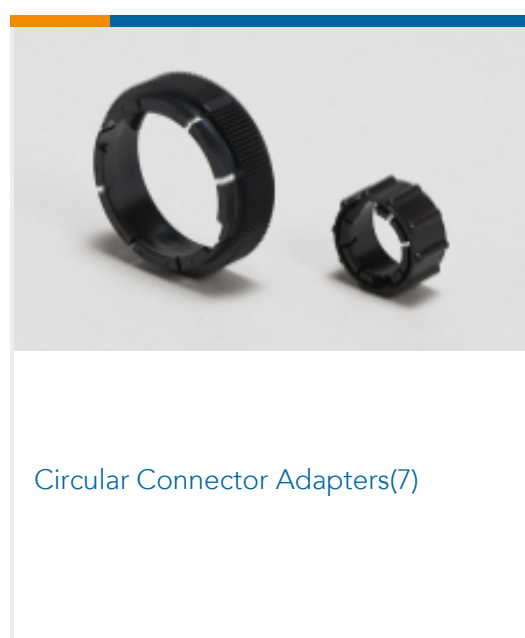

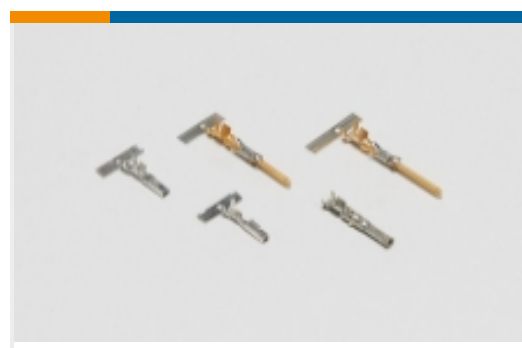

Power Contacts(6)

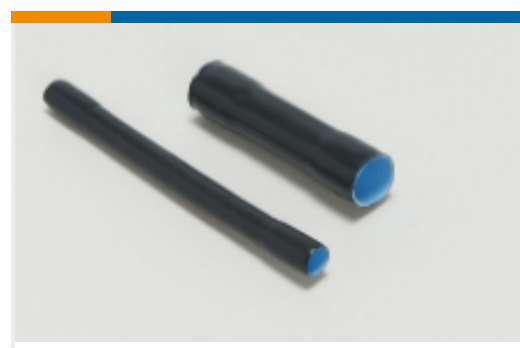

Sealing Sleeves(2)



Unscreened Circular Connector Backshells & Clamps(5)

Customers Also Bought

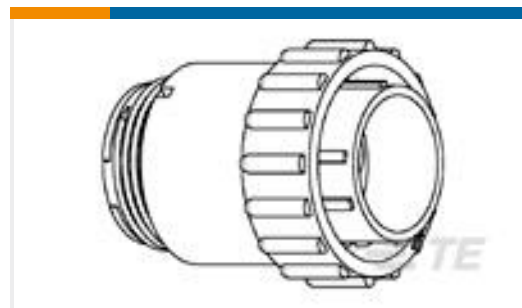
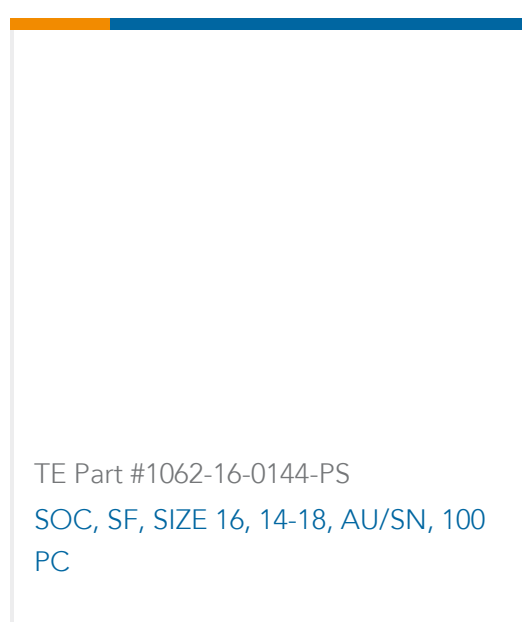
TE Part #788188-1
CPC 17-3 PLUG ASY, REV SEXTE Part #796380-2
R/A STRN RELIEF KIT, SZ 13, CPCTE Part #770086-1
06P .093 COMM P&S RECPT HSGTE Part #35111
TERMINAL, PIDG R 12-10 5/16TE Part #1-2308265-5
QL SET FOR VARIANT B 5TE Part #YDTS24T25-35SNV001
RECP ASSYTE Part #YDTS26W25-20BNV001
PLUG ASSYTE Part #YDIV46E23-55SDC003
PLUG ASSYTE Part #1062-16-0144-PS
SOC, SF, SIZE 16, 14-18, AU/SN, 100 PC

Documents

Product Drawings

[R/A STRN RELIEF KIT, SZ 17, CPC](#)

English

CAD Files

[Customer View Model](#)

[ENG_CVM_CVM_796381-2_D.2d_dxf.zip](#)

English

[3D PDF](#)



3D

Customer View Model

[ENG_CVM_CVM_796381-2_D.3d_igs.zip](#)

English

Customer View Model

[ENG_CVM_CVM_796381-2_D.3d_stp.zip](#)

English

By downloading the CAD file I accept and agree to the [Terms and Conditions](#) of use.

Product Environmental Compliance

[TE Material Declaration](#)

English