

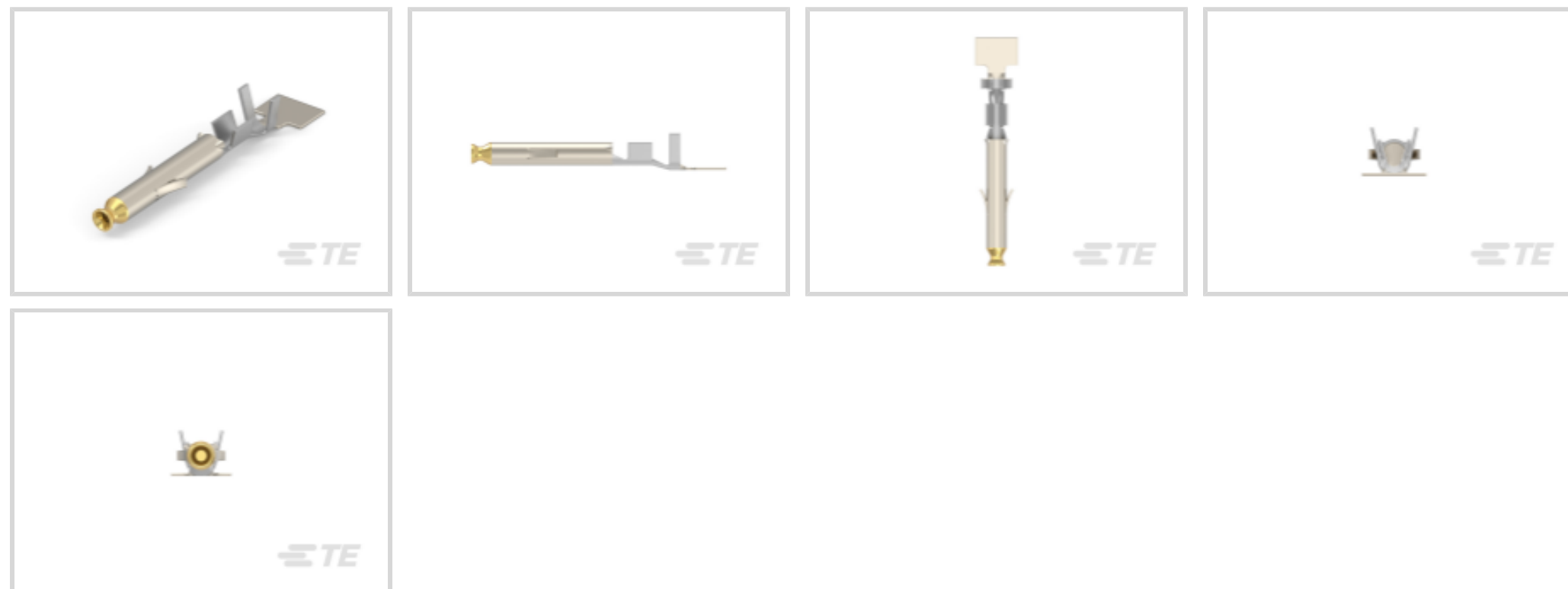

Connectors &gt; Rectangular Connectors &gt; Connector Contacts

Contact Type: **Socket**Contact Mating Area Plating Material: **Gold**Wire Contact Termination Area Plating Material: **Tin-Lead**Operating Voltage: **600 VDC**

## Features

### Product Type Features

Discrete Wire Type	Stranded
Glow Wire Rating	Standard Part - Not Glow Wire
Connector System	Wire-to-Wire
Connector & Contact Terminates To	Wire & Cable

### Configuration Features

Compatible With Wire & Cable Type	Discrete Wire
-----------------------------------	---------------

### Electrical Characteristics

Operating Voltage	600 VDC
-------------------	---------

### Contact Features

Contact Diameter	1.8 mm[.071 in]
Underplate Material Thickness	1.27 $\mu$ m[50 $\mu$ in]
Contact Mating Area Plating Thickness	.76 $\mu$ m[29.92 $\mu$ in]
Contact Underplating Material	Nickel
Contact Type	Socket



Contact Mating Area Plating Material	Gold
Wire Contact Termination Area Plating Material	Tin-Lead
Contact Retention Within Housing	With
Contact Base Material	Phosphor Bronze
Contact Current Rating (Max)	11.2 A

### Termination Features

Termination Method to Wire & Cable	Crimp
------------------------------------	-------

### Mechanical Attachment

Contact Retention Type Within Housing	Locking Lance
Connector Mounting Type	Cable Mount (Free-Hanging)

### Dimensions

Accepts Wire Insulation Diameter Range	1.2 – 1.75 mm [.047 – .069 in]
Wire Size	.12 – .4 mm <sup>2</sup>

### Usage Conditions

Operating Temperature Range	-55 – 105 °C [-67 – 221 °F]
-----------------------------	-----------------------------

### Operation/Application

For Use With	Plug Housing
Circuit Application	Power

### Industry Standards

CSA Rating	Certified
CSA File Number	LR 7189
UL File Number	E28476
UL Rating	Recognized
UL Flammability Rating	UL 94V-0
Agency/Standard	CSA, UL
VDE Tested	Yes

### Packaging Features

Packaging Method	Reel
Packaging Quantity	7000

### Other

Comment	HDM Applicator part number ending in -3 is used on AMPOMATOR CLS Machine
---------	--



with T or G Terminators, -4 is used on AMP-O-LECTRIC Model K Machine, -5 is used on AMP-O-LECTRIC Model G Machines.

## Product Compliance

[For compliance documentation, visit the product page on TE.com>](#)









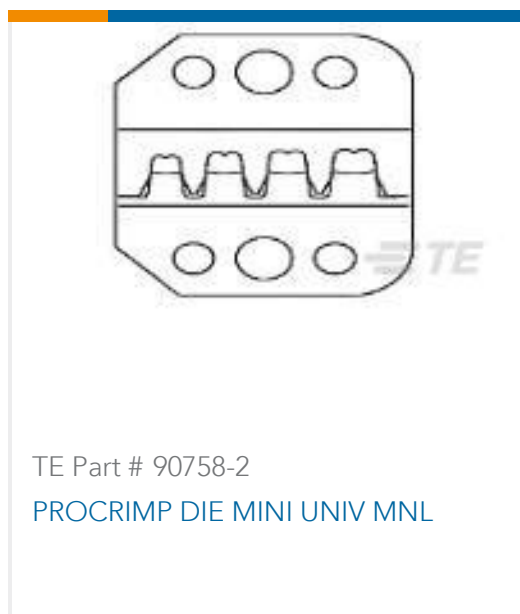

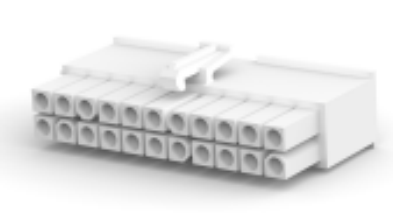

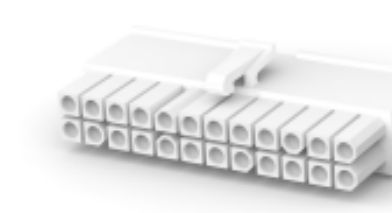
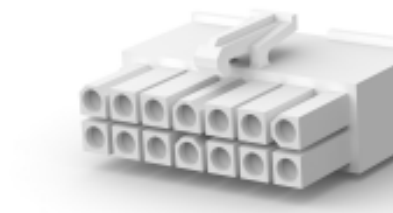
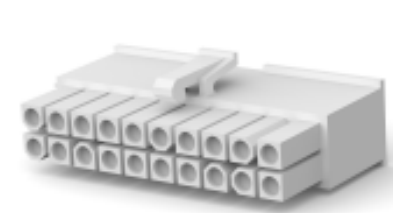

EU RoHS Directive 2011/65/EU	Not Compliant
EU ELV Directive 2000/53/EC	Not Compliant
China RoHS 2 Directive MIIT Order No 32, 2016	Restricted Materials Above Threshold
EU REACH Regulation (EC) No. 1907/2006	Current ECHA Candidate List: JUNE 2022 (224) Candidate List Declared Against: JAN 2022 (223) SVHC > Threshold: Pb (13% in Component Part) <b>Article Safe Usage Statements:</b> Do not eat, drink or smoke when using this product. Wash thoroughly after handling. Recycle if possible and dispose of the article by following all applicable governmental regulations relevant to your geographic location.
Halogen Content	Low Halogen - Br, Cl, F, I < 900 ppm per homogenous material. Also BFR/CFR/PVC Free
Solder Process Capability	Not applicable for solder process capability

### Product Compliance Disclaimer





This information is provided based on reasonable inquiry of our suppliers and represents our current actual knowledge based on the information they provided. This information is subject to change. The part numbers that TE has identified as EU RoHS compliant have a maximum concentration of 0.1% by weight in homogenous materials for lead, hexavalent chromium, mercury, PBB, PBDE, DBP, BBP, DEHP, DIBP, and 0.01% for cadmium, or qualify for an exemption to these limits as defined in the Annexes of Directive 2011/65/EU (RoHS2). Finished electrical and electronic equipment products will be CE marked as required by Directive 2011/65/EU. Components may not be CE marked. Additionally, the part numbers that TE has identified as EU ELV compliant have a maximum concentration of 0.1% by weight in homogenous materials for lead, hexavalent chromium, and mercury, and 0.01% for cadmium, or qualify for an exemption to these limits as defined in the Annexes of Directive 2000/53/EC (ELV). Regarding the REACH Regulation, the information TE provides on SVHC in articles for this part number is based on the latest European Chemicals Agency (ECHA) 'Guidance on requirements for substances in articles' posted at this URL: <https://echa.europa.eu/guidance-documents/guidance-on-reach>

## Compatible Parts

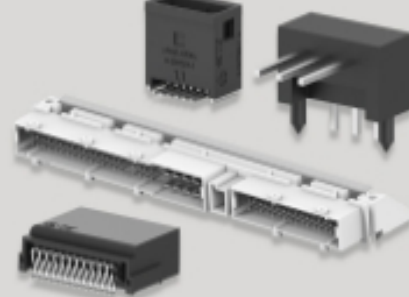

 <p>TE Part # 770586-1 22P MINI UMNL PLUG HSG</p>	 <p>TE Part # 794942-1 10P MINI UMNL CAP HSG</p>	 <p>TE Part # 770587-1 24P MINI UMNL PLUG HSG</p>	 <p>TE Part # 770582-1 14P MINI UMNL PLUG HSG</p>
 <p>TE Part # 770585-1 20P MINI UMNL PLUG HSG</p>	 <p>TE Part # 172333-1 MINI UNIVERSAL M-N-L HOUSING</p>	 <p>TE Part # 794781-1 10P MINI UMNL PLUG HSG</p>	 <p>TE Part # 794941-1 08P MINI UMNL CAP HSG</p>
 <p>TE Part # 794821-1 08P MINI UMNL PLUG HSG</p>	 <p>TE Part # 794940-1 06P MINI UMNL CAP HSG</p>	 <p>TE Part # 770581-1 12P MINI UMNL PLUG HSG</p>	 <p>TE Part # 770580-1 10P MINI UMNL PLUG HSG</p>
 <p>TE Part # 770584-1 18P MINI UMNL PLUG HSG</p>	 <p>TE Part # 172328-1 MINI UNIVERSAL MATE-N-LOK CAP HOUSING 2P</p>	 <p>TE Part # 172330-1 MINI UNIVERSAL MATE-N-LOK CAP HOUSING 4P</p>	 <p>TE Part # 172170-1 12 CIR UNIV M-N-L PLUG</p>

Also in the Series | **Mini-Universal MATE-N-LOK**

 <p>Connector Contacts(11)</p>	 <p>Insertion &amp; Extraction Tools(1)</p>	 <p>PCB Headers &amp; Receptacles(1)</p>	 <p>Power Contacts(85)</p>
---	--	---	---





Rectangular Backshells & Clamps(2)

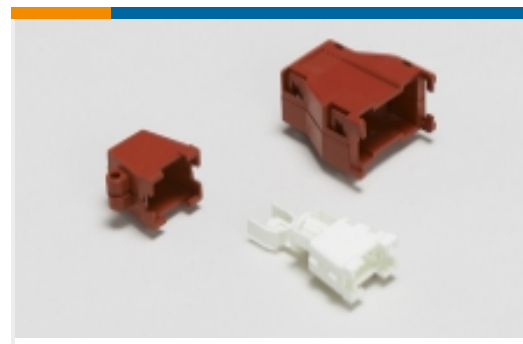

Rectangular Boots & Strain Relief(2)



Rectangular Connector Keying Plugs(2)



Rectangular Connector Locking(2)

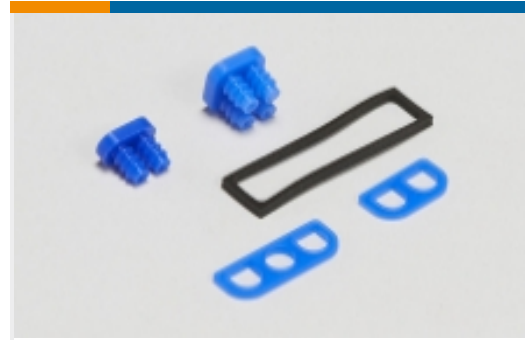

Rectangular Connector Seals(20)



Rectangular Power Connectors(283)

## Customers Also Bought



TE Part #66598-2  
TYPE III CONTACTS STRIP



TE Part #776349-1  
Contacts: Size 16, 13A



TE Part #2176057-8  
RLP73V 3A R020 1% 1K RL

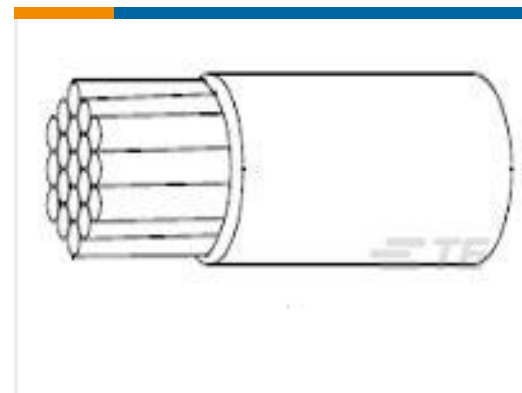

TE Part #216027-008  
55A0111-26-9



TE Part #EH3264-000  
ZH150-8/4-0-SP

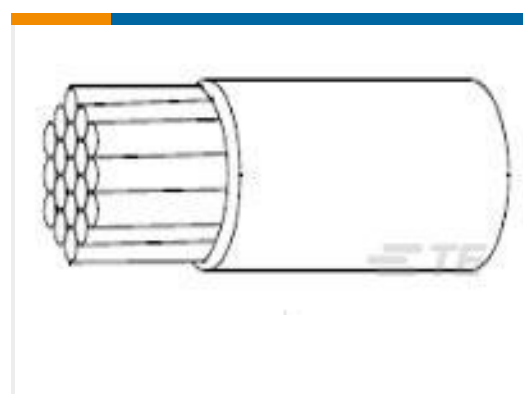

TE Part #216246-000  
55A0111-26-0



TE Part #1-770872-1  
02P MINI UMNL HDR ASSY AU LF



TE Part #1903747-1  
MINI UMNL GWT 2P PLUG HSG

## Documents

### Product Drawings

[MINI UMNL SOK 26-22 AWG AU](#)

English

### CAD Files

Customer View Model

[ENG\\_CVM\\_CVM\\_770902-6\\_T.2d\\_dxf.zip](#)

English

[3D PDF](#)



3D

Customer View Model

[ENG\\_CVM\\_CVM\\_770902-6\\_T.3d\\_igs.zip](#)

English

Customer View Model

[ENG\\_CVM\\_CVM\\_770902-6\\_T.3d\\_stp.zip](#)

English

By downloading the CAD file I accept and agree to the [Terms and Conditions](#) of use.

---

### Datasheets & Catalog Pages

[SOFT\\_SHELL\\_PIN\\_AND\\_SOCKET\\_CONNECTORS\\_CATALOG](#)

English

---

### Instruction Sheets

[Instruction Sheet \(U.S.\)](#)

English