

87133-5 ✓ ACTIVE

AMPMODU | AMPMODU LOCKING CLIP

TE Internal #: 87133-5

Housing, Receptacle, Wire-to-Board, 10 Position, 2.54 mm [.1 in]

Centerline, Crimp, 2 Row, Black, Wire & Cable, Power & Signal,

AMPMODU LOCKING CLIP

[View on TE.com >](#)



Connectors > PCB Connectors > Wire-to-Board Connectors > Wire-to-Board Connector Assemblies & Housings



Connector Product Type: **Housing**

Connector & Housing Type: **Receptacle**

Connector System: **Wire-to-Board**

Number of Positions: **10**

Centerline (Pitch): **2.54 mm [.1 in]**

Features

Product Type Features

Connector Product Type	Housing
Connector & Housing Type	Receptacle
Connector System	Wire-to-Board
Connector & Contact Terminates To	Wire & Cable

Configuration Features

Number of Positions	10
Number of Rows	2

Electrical Characteristics

Termination Resistance	12 mΩ
Insulation Resistance	5000 MΩ
Dielectric Withstanding Voltage (Max)	750 V
Operating Voltage	250 VAC

Contact Features

Contact Type	Socket
Contact Current Rating (Max)	3 A

Termination Features

Termination Method to Wire & Cable	Crimp
------------------------------------	-------

Mechanical Attachment



Mating Retention Type	Lock
-----------------------	------

Mating Retention	Without
------------------	---------

Housing Features

Housing Entry Configuration	Both Ends Closed
-----------------------------	------------------

Housing Material	Polyester GF
------------------	--------------

Centerline (Pitch)	2.54 mm [.1 in]
--------------------	-----------------

Housing Color	Black
---------------	-------

Dimensions

Connector Length	13.11 mm [.516 in]
------------------	--------------------

Connector Height	7.62 mm [.3 in]
------------------	-----------------

Row-to-Row Spacing	2.54 mm [.1 in]
--------------------	-----------------

Usage Conditions

Operating Temperature Range	-65 – 105 °C [-85 – 221 °F]
-----------------------------	-----------------------------

Operation/Application

Circuit Application	Power & Signal
---------------------	----------------

Industry Standards

Glow Wire Rating	Standard Part - Not Glow Wire
------------------	-------------------------------

Approved Standards	CSA LR7189, UL E28476
--------------------	-----------------------

UL Flammability Rating	UL 94V-0
------------------------	----------

Packaging Features

Packaging Quantity	250
--------------------	-----

Packaging Method	Bag
------------------	-----

Product Compliance

[For compliance documentation, visit the product page on TE.com>](#)

EU RoHS Directive 2011/65/EU	Compliant
------------------------------	-----------

EU ELV Directive 2000/53/EC	Compliant
-----------------------------	-----------

China RoHS 2 Directive MIIT Order No 32, 2016	No Restricted Materials Above Threshold
---	---

EU REACH Regulation (EC) No. 1907/2006	Current ECHA Candidate List: JUNE 2022 (224) Candidate List Declared Against: JAN 2022 (223) SVHC > Threshold: Not Yet Reviewed
--	--

Halogen Content

Not Low Halogen - contains Br or Cl > 900 ppm.

Solder Process Capability

Not applicable for solder process capability

Product Compliance Disclaimer

This information is provided based on reasonable inquiry of our suppliers and represents our current actual knowledge based on the information they provided. This information is subject to change. The part numbers that TE has identified as EU RoHS compliant have a maximum concentration of 0.1% by weight in homogenous materials for lead, hexavalent chromium, mercury, PBB, PBDE, DBP, BBP, DEHP, DIBP, and 0.01% for cadmium, or qualify for an exemption to these limits as defined in the Annexes of Directive 2011/65/EU (RoHS2). Finished electrical and electronic equipment products will be CE marked as required by Directive 2011/65/EU. Components may not be CE marked. Additionally, the part numbers that TE has identified as EU ELV compliant have a maximum concentration of 0.1% by weight in homogenous materials for lead, hexavalent chromium, and mercury, and 0.01% for cadmium, or qualify for an exemption to these limits as defined in the Annexes of Directive 2000/53/EC (ELV). Regarding the REACH Regulation, the information TE provides on SVHC in articles for this part number is based on the latest European Chemicals Agency (ECHA) 'Guidance on requirements for substances in articles' posted at this URL: <https://echa.europa.eu/guidance-documents/guidance-on-reach>

Compatible Parts



TE Part # 5-87165-2
LOCKING CLIP ASSY .025 SQ LP



TE Part # 87179-1
LOCKING CLIP KEYING PLUG



TE Part # 87190-1
LOCKING CLIP CONT ASSY .025 SQ



TE Part # 867052-2
LOCKING CLIP CONT ASSY .025 SQ



TE Part # 5-87124-2
LOCKING CLIP CONT ASY .025 SQ



TE Part # 87124-1
LOCKING CLIP CONT ASSY .025 SQ



TE Part # 5-87191-2
LOCKING CLIP ASSY .025 SQ LP



TE Part # 867052-1
LOCKING CLIP CONT ASSY .025 SQ



TE Part # 87165-2
LOCKING CLIP ASSY .025 SQ LP



TE Part # 5-102975-5
10 MODII HDR DRRA B/A .100CL



TE Part # 103777-5
10 MODII HDR DRST B/A .100CL



TE Part # 5-103324-5
10 MODII HDR DRRA B/A .100CL LF



TE Part # 5-147279-2
10 MODII HDR DR SFMT B/A T&R LF



TE Part # 104350-5
10 MODII HDR DRST B/A W/HD



TE Part # 5-103326-5
10 MODII HDR DRRR B/A .100CL

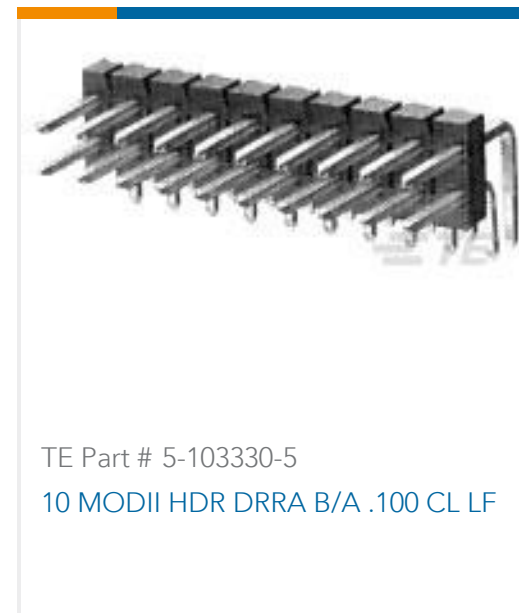

TE Part # 5-103330-5
10 MODII HDR DRRR B/A .100 CL LF



TE Part # 5-147292-2
10 MODII HDR DR SFMT B/A T&R



TE Part # 104351-5
10 MODII HDR DRST B/A W/HD

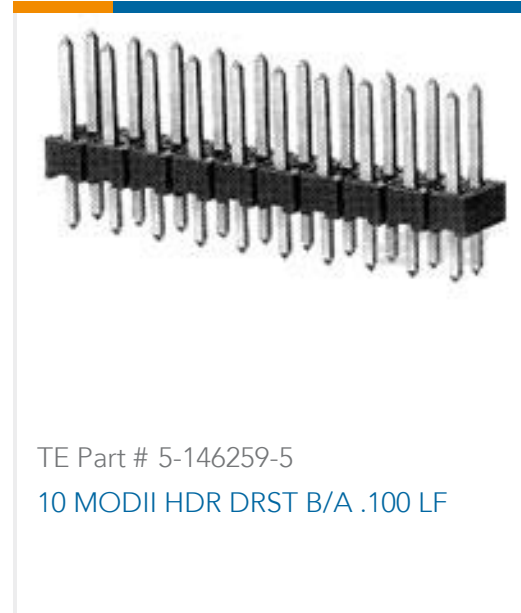

TE Part # 5-146259-5
10 MODII HDR DRST B/A .100 LF



TE Part # 91084-1
EXTRACTION TOOL

Also in the Series | AMPMODU LOCKING CLIP

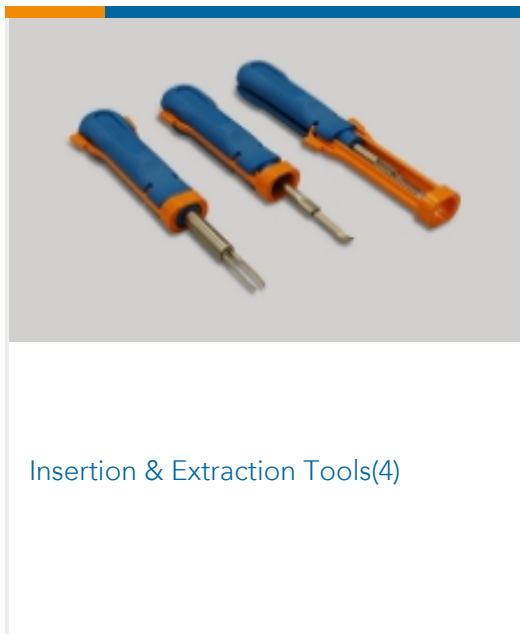

Insertion & Extraction Tools(4)



PCB Connector Keying(1)

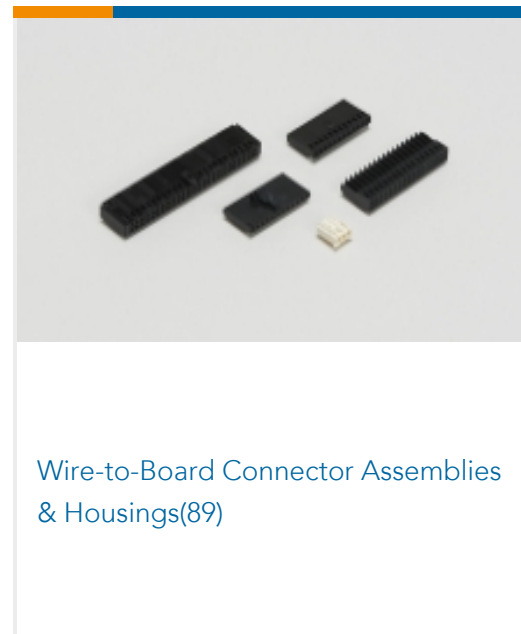

Wire-to-Board Connector Assemblies
& Housings(89)

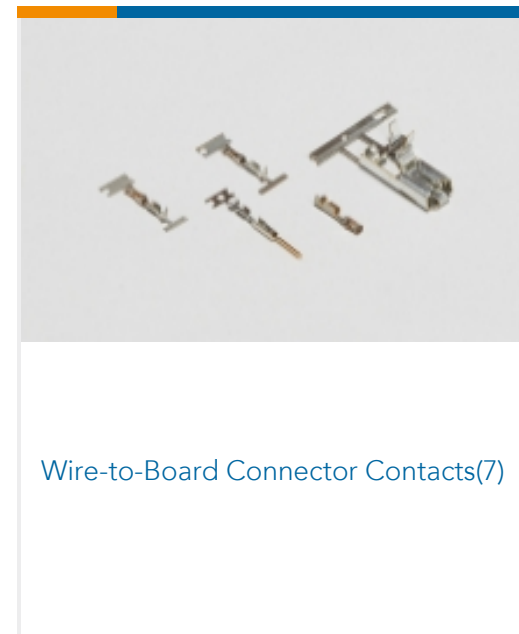

Wire-to-Board Connector Contacts(7)

Customers Also Bought



TE Part #1658683-1
HDP-22,RCPT,SIZE 3,44 POSN



TE Part #1658671-1
HDP-22,PLUG,SIZE 2, 26 POSN



TE Part #32588
TERMINAL,PIDG SPD 12-10 8



TE Part #745254-2
20DF PIN CONTACT,PLATED



TE Part #1-6609032-6
10VR7=F7208 S0

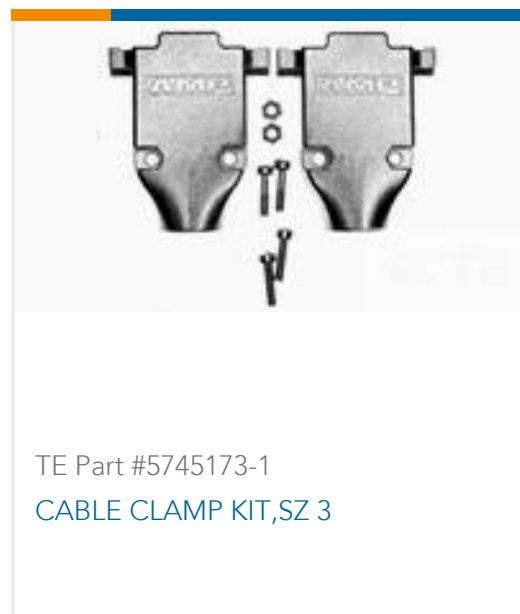

TE Part #5745173-1
CABLE CLAMP KIT,SZ 3



TE Part #1-794617-2
12POS,MICRO MNL,RCPT HSG



TE Part #745779-2
HD SQZ TO RELEASE KIT



TE Part #323915
TERMINAL,PIDG R 26-22 6

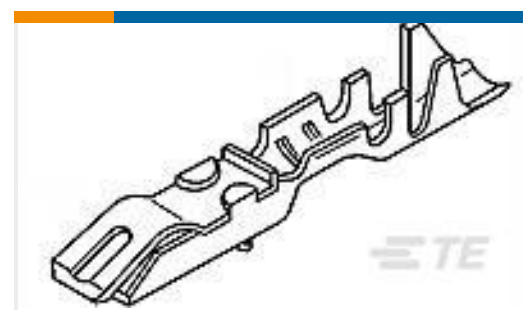

TE Part #87165-1
LOCKING CLIP ASSY .025 SQ LP

Documents

Product Drawings

[10 LOCKING CLIP HSG DR MRKD](#)

English

CAD Files

[3D PDF](#)

3D

Customer View Model

[ENG_CVM_CVM_87133-5_AB.2d_dxf.zip](#)

English

Customer View Model

[ENG_CVM_CVM_87133-5_AB.3d_igs.zip](#)

English

Customer View Model

[ENG_CVM_CVM_87133-5_AB.3d_stp.zip](#)

English

By downloading the CAD file I accept and agree to the [Terms and Conditions](#) of use.

Datasheets & Catalog Pages

[AMPMODU_INTERCONNECTION_SYSTEM_SECTION5_CONT](#)

English

Product Environmental Compliance

[MD_87133-5_04172015122_dmtec](#)

English

[MD_87133-5_04172015122_dmtec](#)

English

Instruction Sheets

[Instruction Sheet \(U.S.\)](#)

English

[AMPMODU Locking Clip Contacts and Housings for 0.64mm Square Posts](#)

English