

776349-3 ✓ ACTIVE

AMP | AMPSEAL 16

TE Internal #: 776349-3

Automotive Terminals, Pin, Pin Diameter .063 in [1.59 mm], 20 – 18

AWG Wire Size, .5 – .8 mm² Wire Size, Locking Clean Body,

AMPSEAL 16

[View on TE.com >](#)



Terminals & Splices > Automotive Terminals > Contacts: Size 16, 13A



Terminal Type: Pin

Mating Pin Diameter: 1.59 mm [.063 in]

Terminal Transmits: 0 – 24 A (Low Power)

Wire Size: .5 – .8 mm²

[All Contacts: Size 16, 13A \(33\)](#)

Features

Product Type Features

Receptacle Style	180°
Sealable	No
Primary Locking Feature	Clean Body

Contact Features

Contact Size	Size 16
Contact Fabrication	Stamped & Formed
Typical Current Rating	13 A
Crimp Type	F-Crimp
Terminal Type	Pin
Mating Pin Diameter	1.59 mm [.063 in]
Interface Plating	Nickel (Ni)

Termination Features

Termination Method to Wire & Cable	Crimp
Product Terminates To	Wire

Dimensions

Wire Size	.5 – .8 mm ²
-----------	-------------------------



Wire Size Search	18 AWG, 19 AWG, 20 AWG
------------------	------------------------

Wire Insulation Diameter	2.26 – 3.32 mm [.089 – .131 in]
--------------------------	---------------------------------

Usage Conditions

Insulation Option	Uninsulated
-------------------	-------------

Operating Temperature (Max)	80 °C, 85 °C, 90 °C, 100 °C, 105 °C, 110 °C, 120 °C [176 °F][185 °F][194 °F][212 °F][221 °F][230 °F][248 °F]
-----------------------------	--

Operating Temperature Range	-40 – 120 °C [-40 – 248 °F]
-----------------------------	-----------------------------

Operation/Application

Compatible With Wire Base Material	Copper
------------------------------------	--------

Packaging Features

Packaging Method	Reel
------------------	------

Packaging Quantity	4000
--------------------	------

Other

Terminal Transmits	0 – 24 A (Low Power)
--------------------	----------------------

Product Compliance

[For compliance documentation, visit the product page on TE.com>](#)

EU RoHS Directive 2011/65/EU	Compliant
------------------------------	-----------

EU ELV Directive 2000/53/EC	Compliant
-----------------------------	-----------

China RoHS 2 Directive MIIT Order No 32, 2016	No Restricted Materials Above Threshold
---	---

EU REACH Regulation (EC) No. 1907/2006	Current ECHA Candidate List: JUNE 2022 (224) Candidate List Declared Against: JAN 2022 (223) SVHC > Threshold: Not Yet Reviewed
--	--

Halogen Content	Low Halogen - Br, Cl, F, I < 900 ppm per homogenous material. Also BFR/CFR/PVC Free
-----------------	---

Solder Process Capability	Not applicable for solder process capability
---------------------------	--

Product Compliance Disclaimer

This information is provided based on reasonable inquiry of our suppliers and represents our current actual knowledge based on the information they provided. This information is subject to change. The part numbers that TE has identified as EU RoHS compliant have a maximum concentration of 0.1% by weight in homogenous materials for lead, hexavalent chromium, mercury, PBB, PBDE, DBP, BBP, DEHP, DIBP, and 0.01% for cadmium, or qualify for an exemption to these limits as defined in the Annexes of Directive 2011/65/EU (RoHS2). Finished electrical and electronic equipment products will be CE marked as required by Directive 2011/65/EU. Components may not be CE marked. Additionally, the part

numbers that TE has identified as EU ELV compliant have a maximum concentration of 0.1% by weight in homogenous materials for lead, hexavalent chromium, and mercury, and 0.01% for cadmium, or qualify for an exemption to these limits as defined in the Annexes of Directive 2000/53/EC (ELV). Regarding the REACH Regulation, the information TE provides on SVHC in articles for this part number is based on the latest European Chemicals Agency (ECHA) 'Guidance on requirements for substances in articles' posted at this URL: <https://echa.europa.eu/guidance-documents/guidance-on-reach>

Compatible Parts



TE Part # 91337-1
SIZE 16 PRO-CRIMPER ASSY.



TE Part # 2305570-1
TERMINAL CUTTER, SIDE FEED



TE Part # CAT-AM7801-CH8172
AMPSEAL 16 HOUSINGS



TE Part # 2151731-1
OCEAN_2.0_Applicator-S-100F1300

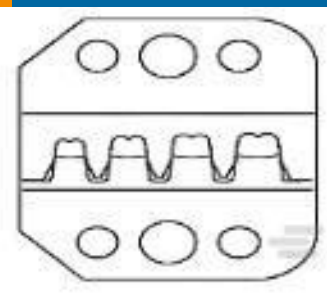

TE Part # 91337-2
SIZE 16 PRO-CRIMPER DIE



TE Part # 2-2151731-1
OCEAN_2.0_Applicator-S-100F1300



TE Part # 2-2151731-2
OCEAN_2.0_Applicator-S-100F1300



TE Part # 2151731-2
OCEAN_2.0_Applicator-S-100F1300



TE Part # 2320913-1
2POS,AMPSEAL 16,PIN HSG ASSY,
SLD,COD 1



TE Part # 2320913-2
2POS,AMPSEAL 16,PIN HSG ASSY,
SLD,COD 2



TE Part # 2320913-3
2POS,AMPSEAL 16,PIN HSG ASSY,
SLD,COD 3



TE Part # 2320913-4
2POS,AMPSEAL 16,PIN HSG ASSY,
SLD,COD 4



TE Part # 5-2151731-1
OCEAN_2.0_Applicator-S-100F1300



TE Part # 5-2151731-2
OCEAN_2.0_Applicator-S-100F1300



TE Part # 7-2151238-7
OC-100F1300-752-
CRIMPTOOLINGKIT



TE Part # 7-2151731-1
OCEAN_2.0_Applicator-S-100F1300



Also in the Series | **AMPSEAL 16**

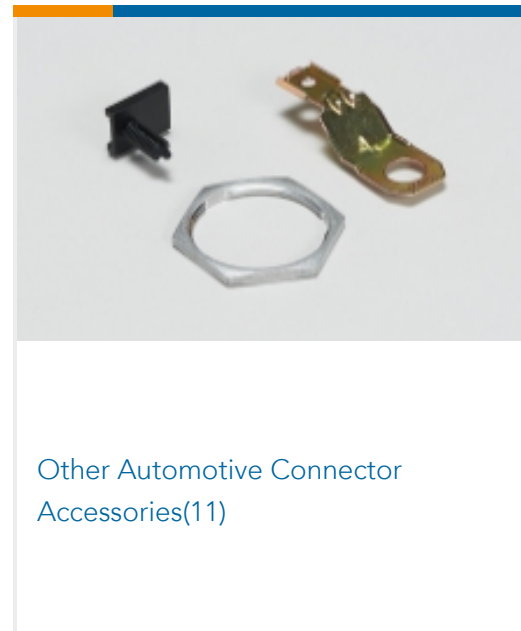
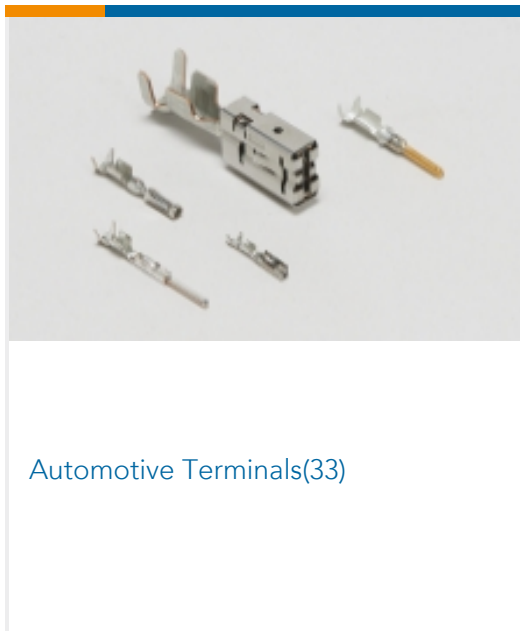
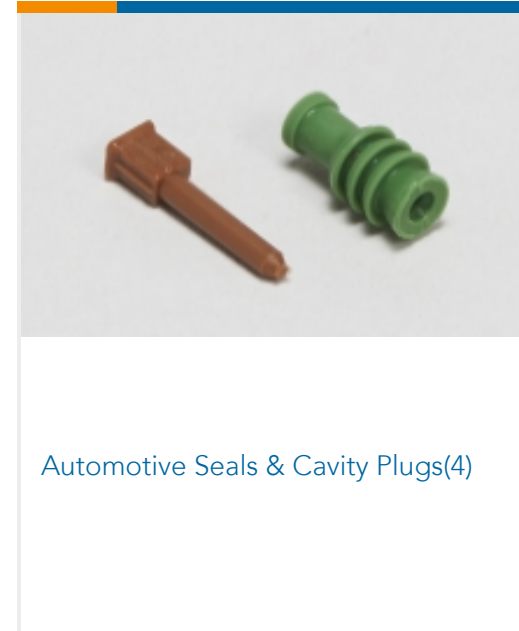
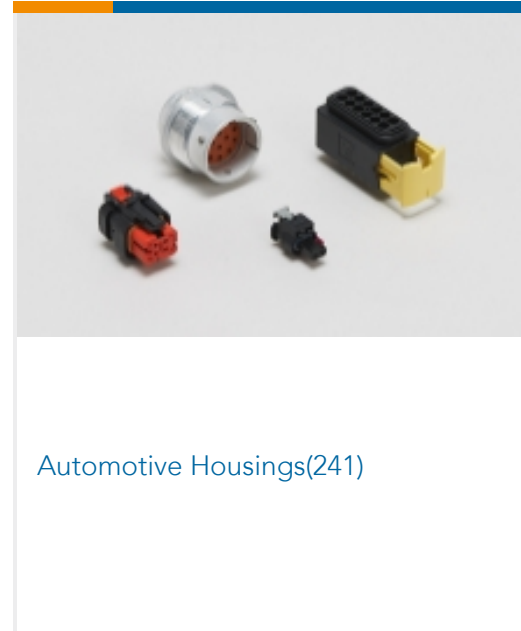
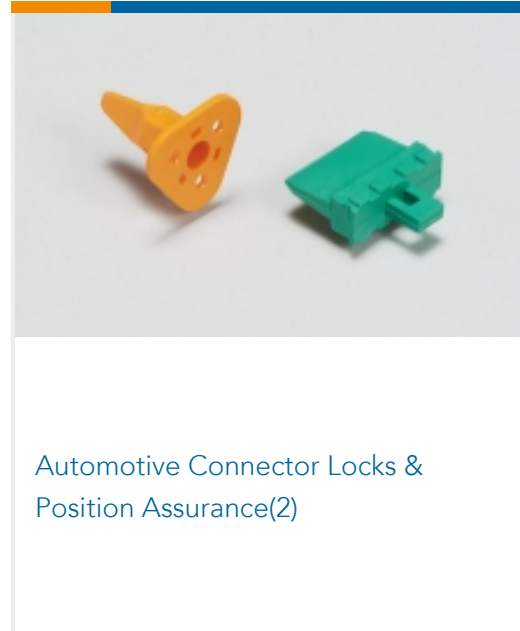
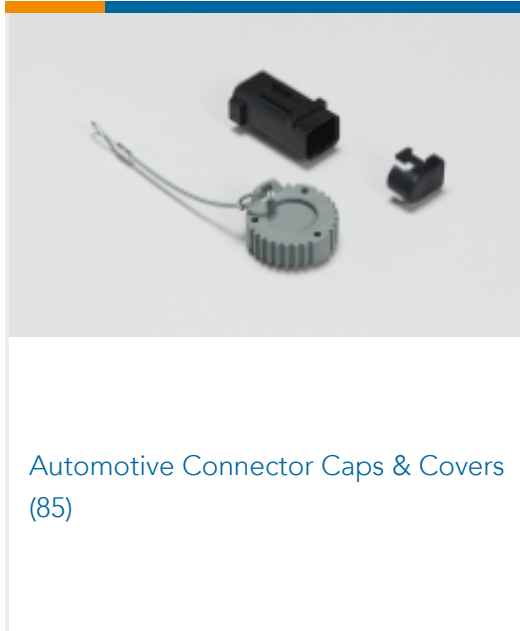

Customers Also Bought





Documents

Product Drawings

[PIN, SF, SIZE 16, 18-20 AWG, NI/SN](#)

English

CAD Files

Customer View Model

[ENG_CVM_776349-3_C1.3d_igs.zip](#)

English

Customer View Model

[ENG_CVM_776349-3_C1.3d_stp.zip](#)

English

Customer View Model

[ENG_CVM_776349-3_C1.2d_dxf.zip](#)

English

[3D PDF](#)

English

By downloading the CAD file I accept and agree to the [Terms and Conditions](#) of use.

Datasheets & Catalog Pages

[ICT Terminals and Connectors Catalogue](#)

English

[CONNECTOR SELECTOR](#)

English

Product Specifications

[Application Specification](#)

English