

87666-2 ✓ ACTIVE

AMPMODU | AMPMODU IV/V

TE Internal #: 87666-2

Connector Contact, Socket, Wire-to-Board, 26 – 22 AWG Wire Size,
236.823 – 789.41 CMA Wire Size, .12 – .4 mm² Wire Size, Gold, Reel,
AMPMODU IV/V

[View on TE.com >](#)



Connectors > PCB Connectors > Wire-to-Board Connectors > Wire-to-Board Connector Contacts



Contact Type: **Socket**

Connector System: **Wire-to-Board**

Wire Size: .12 – .4 mm²

Features

Product Type Features

Applied Pressure	Standard
Connector System	Wire-to-Board
Connector & Contact Terminates To	Wire & Cable

Configuration Features

Compatible With Wire & Cable Type	Discrete Wire
-----------------------------------	---------------

Electrical Characteristics

Termination Resistance	12 mΩ
Insulation Resistance	5000 MΩ
Dielectric Withstanding Voltage (Max)	750 V
Operating Voltage	250 VAC

Contact Features

Mating Square Post Dimension	.64 mm[.025 in]
	30 μin
Wire Contact Termination Area Plating Material	Gold Flash
Contact Base Material	Beryllium Copper
Contact Type	Socket
Contact Mating Area Plating Material	Gold
Contact Current Rating (Max)	3 A

Termination Features



Termination Method to Wire & Cable	Crimp
------------------------------------	-------

Mechanical Attachment

Wire Insulation Support	With
-------------------------	------

Dimensions

Accepts Wire Insulation Diameter Range	1.55 mm[.061 in]
--	------------------

Wire Size	.12 – .4 mm ²
-----------	--------------------------

Usage Conditions

Operating Temperature Range	-65 – 105 °C[-85 – 221 °F]
-----------------------------	----------------------------

Operation/Application

Circuit Application	Power & Signal
---------------------	----------------

Industry Standards

Approved Standards	CSA LR7189, UL E28476
--------------------	-----------------------

Packaging Features

Packaging Quantity	12500
--------------------	-------

Packaging Method	Reel
------------------	------

Other

Comment	(*) For use with Model "K" machines. Call the Technical Assistance Center (1-800-522-6752) for any tooling questions.
---------	---

Product Compliance

[For compliance documentation, visit the product page on TE.com>](#)

EU RoHS Directive 2011/65/EU	Compliant
------------------------------	-----------

EU ELV Directive 2000/53/EC	Compliant
-----------------------------	-----------

China RoHS 2 Directive MIIT Order No 32, 2016	No Restricted Materials Above Threshold
---	---

EU REACH Regulation (EC) No. 1907/2006	Current ECHA Candidate List: JUNE 2022 (224) Candidate List Declared Against: JAN 2022 (223) SVHC > Threshold: Not Yet Reviewed
--	--

Halogen Content	Low Halogen - Br, Cl, F, I < 900 ppm per homogenous material. Also BFR/CFR/PVC Free
-----------------	---

Solder Process Capability	Not applicable for solder process capability
---------------------------	--

Product Compliance Disclaimer

This information is provided based on reasonable inquiry of our suppliers and represents our current actual knowledge based on the information they provided. This information is subject to change. The part numbers that TE has identified as EU RoHS compliant have a maximum concentration of 0.1% by weight in homogenous materials for lead, hexavalent chromium, mercury, PBB, PBDE, DBP, BBP, DEHP, DIBP, and 0.01% for cadmium, or qualify for an exemption to these limits as defined in the Annexes of Directive 2011/65/EU (RoHS2). Finished electrical and electronic equipment products will be CE marked as required by Directive 2011/65/EU. Components may not be CE marked. Additionally, the part numbers that TE has identified as EU ELV compliant have a maximum concentration of 0.1% by weight in homogenous materials for lead, hexavalent chromium, and mercury, and 0.01% for cadmium, or qualify for an exemption to these limits as defined in the Annexes of Directive 2000/53/EC (ELV). Regarding the REACH Regulation, the information TE provides on SVHC in articles for this part number is based on the latest European Chemicals Agency (ECHA) 'Guidance on requirements for substances in articles' posted at this URL: <https://echa.europa.eu/guidance-documents/guidance-on-reach>

Compatible Parts



TE Part # 91517-1
CCII FEMALE MOD IV REC 24-22 ASSY



TE Part # 1-87499-7
10 MODIV HSG SR MRKD .100CL



TE Part # 1-102387-2
64 MODIV HSG COMP DR .100 POL

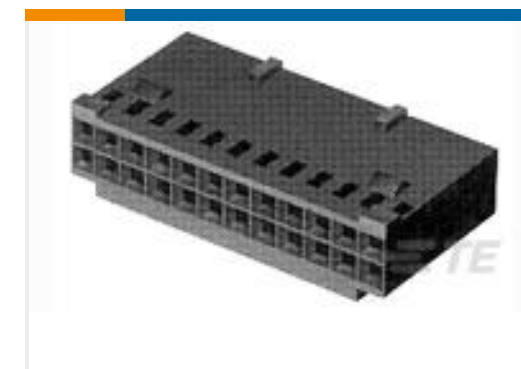

TE Part # 1-87631-2
16 MODIV HSG DR MRKD .100 POL



TE Part # 87499-7
04 MODIV HSG SR MRKD .100CL

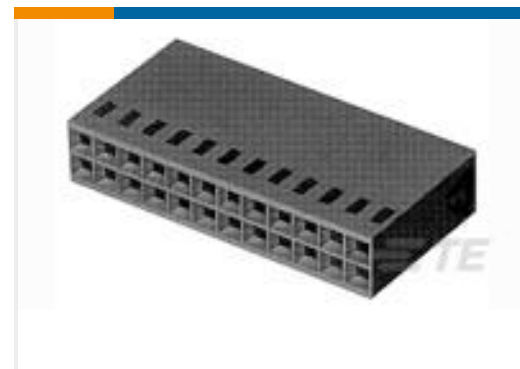

TE Part # 2-87456-1
26 MODIV HSG COMP DR .100CL

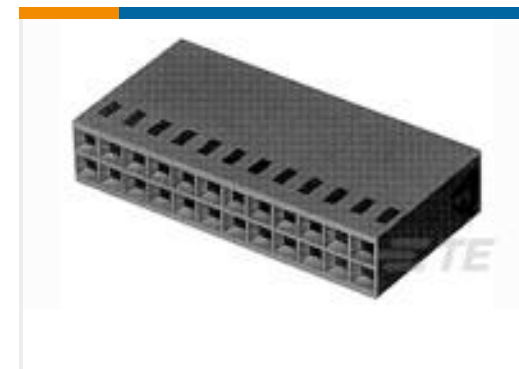

TE Part # 1-87456-5
20 MODIV HSG COMP DR .100CL

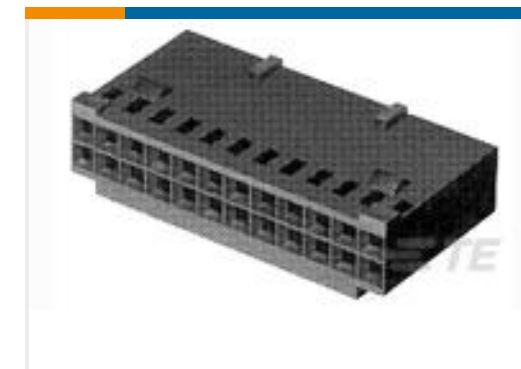

TE Part # 1-87631-6
20 MODIV HSG DR MRKD .100 POL

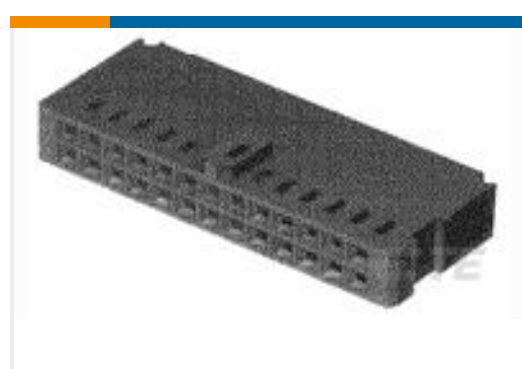

TE Part # 1-102387-0
50 MODIV HSG COMP DR .100 POL

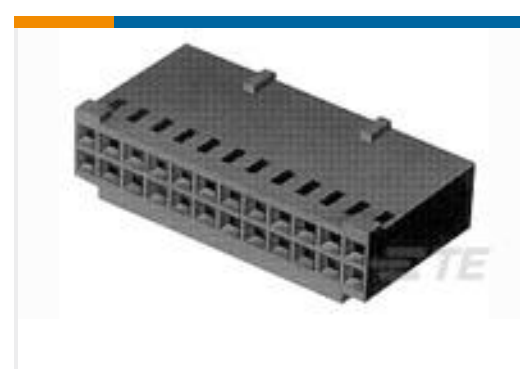

TE Part # 87977-8
20 MODIV HSG DR MRKD .100 POL

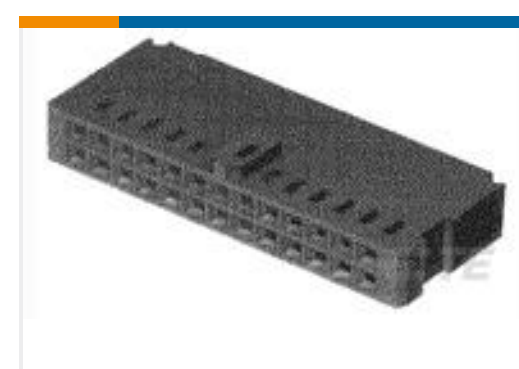

TE Part # 102387-5
24 MODIV HSG COMP DR .100 POL



TE Part # 102241-6
08 MODIV HSG COMP SR .100 POL



Also in the Series | AMPMODU IV/V

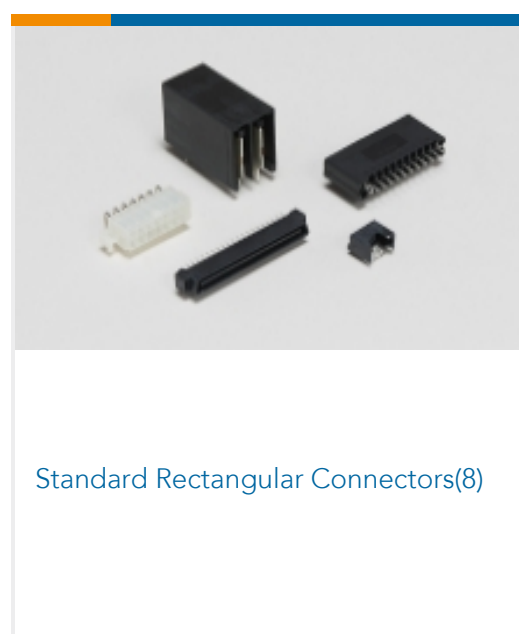
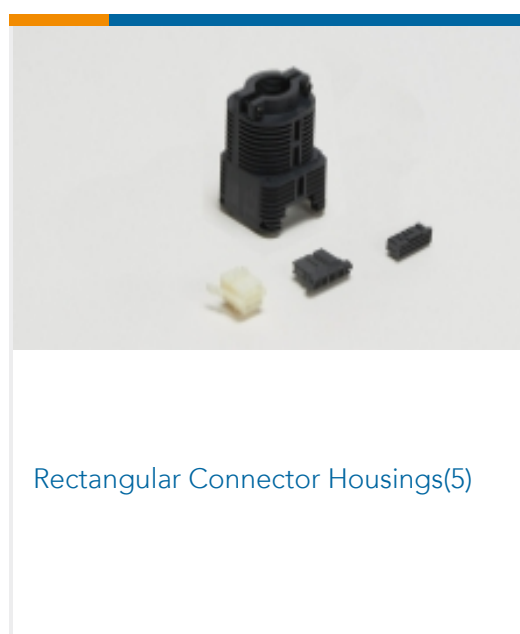
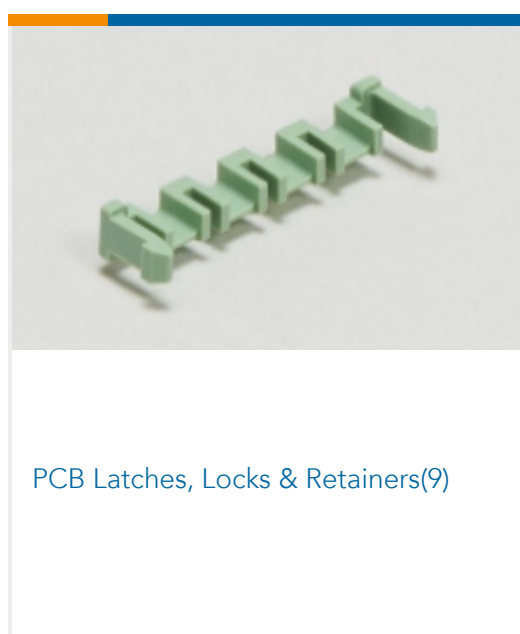
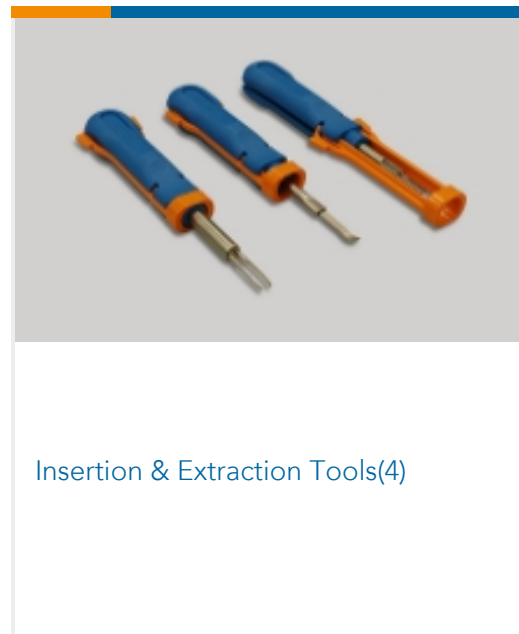
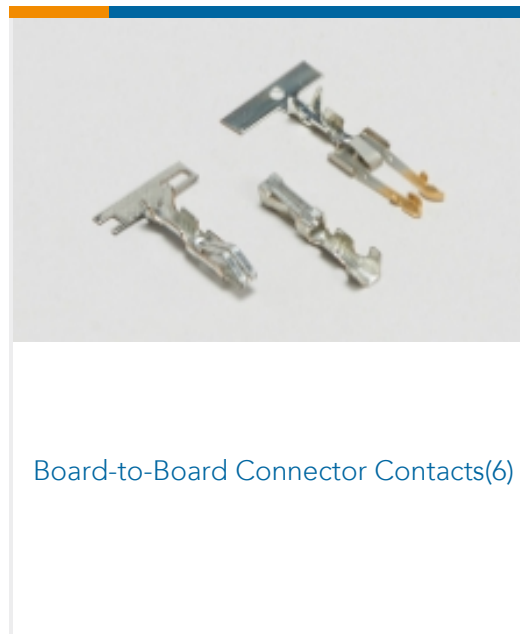
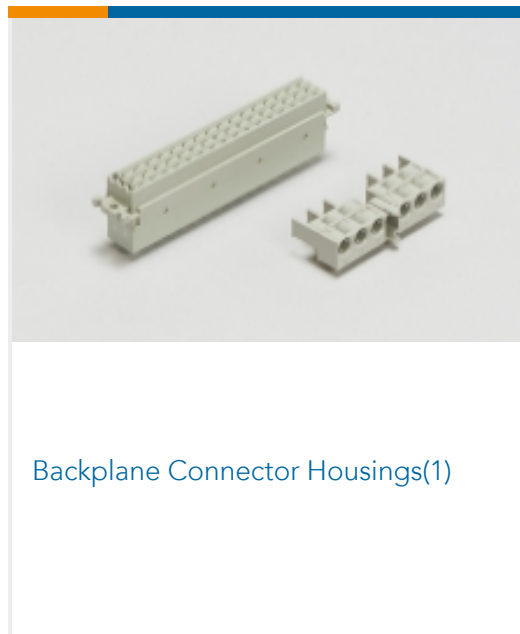
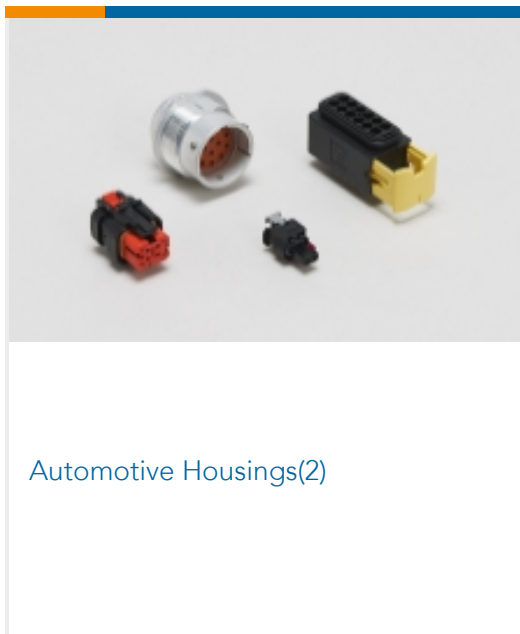

Wire-to-Board Connector Assemblies
& Housings(467)Wire-to-Board Connector Contacts
(326)

Customers Also Bought

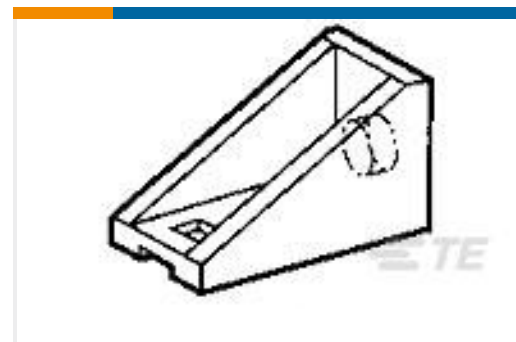
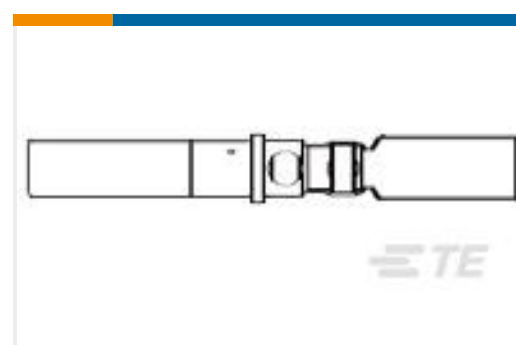
TE Part #1-640251-4
3.96mm Wire-to-board housing:
receptacle, no mating alignment, SL
156TE Part #556879-8
PLUG HSG,AMPINNERGY WTB,8 POSTE Part #53886-1
PNL MT ADAPTER,FEMALE,POWER
LKTE Part #4-641208-2
12P MTA156 HDR ASSY FL ST LFTE Part #4-641208-4
14P MTA156 HDR ASSY FL ST LFTE Part #8-32054-1
PIDG SPD 22-16COMM 22-18MIL 10TE Part #601098-000
D-602-0107

Documents

Product Drawings

[MOD IV RECP PLTD 30 SEL](#)

English

CAD Files

[3D PDF](#)

3D

Customer View Model

[ENG_CVM_CVM_87666-2_AH.2d_dxf.zip](#)

English

Customer View Model

[ENG_CVM_CVM_87666-2_AH.3d_igs.zip](#)

English

Customer View Model

[ENG_CVM_CVM_87666-2_AH.3d_stp.zip](#)

English

By downloading the CAD file I accept and agree to the [Terms and Conditions](#) of use.



Datasheets & Catalog Pages

[AMP MODU IV & V Section of Catalog 1307819](#)

English

[AMPMODU_INTERCONNECTION_SYSTEM_SECTION5_CONT](#)

English

Product Specifications

[Application Specification](#)

English

Product Environmental Compliance

[MD_87666-2_03152018120_dmtec](#)

English

[MD_87666-2_03152018120_dmtec](#)

English