



Connectors > Power Connectors > Power Contacts

Power Contact Type: **Contact**Operating Voltage: **600 VAC**Contact Mating Area Plating Material: **Gold**Wire Size: **.5 – 2 mm²**

Features

Product Type Features

Power Contact Type	Contact
Connector System	Wire-to-Wire
Connector & Contact Terminates To	Wire & Cable

Electrical Characteristics

Operating Voltage	600 VAC
-------------------	---------

Contact Features

Contact Mating Area Plating Material	Gold
Contact Current Rating (Max)	7 A
Contact Type	Socket
Contact Retention Within Housing	Without
Mating Pin Diameter	2.18 mm [.086 in]
Contact Base Material	Phosphor Bronze
Contact Mating Area Plating Material Thickness	.76 μm [30 μin]
Wire Contact Termination Area Plating Thickness	1.27 μm [50 μin]
Wire Contact Termination Area Plating Material	Tin-Lead



Contact Orientation	Straight
Contact Underplating Material	Nickel
Contact Underplating Material Thickness	1.27 μm[50 μin]

Termination Features

Termination Method to Wire & Cable	Crimp
------------------------------------	-------

Mechanical Attachment

Connector Mounting Type	Cable Mount (Free-Hanging)
Wire Insulation Support	Without

Dimensions

Wire Size	.5 – 2 mm ²
Accepts Wire Insulation Diameter Range	3.3 – 5.08 mm[.13 – .2 in]

Usage Conditions

Operating Temperature Range	-55 – 120 °C[-67 – 248 °F]
-----------------------------	----------------------------

Operation/Application

Circuit Application	Power
---------------------	-------

Industry Standards

CSA Rating	Certified
Glow Wire Rating	Standard Part - Not Glow Wire
VDE Tested	Yes
Agency/Standard	CSA, UL
CSA File Number	LR 7189
UL Rating	Recognized
UL File Number	E28476

Packaging Features

Packaging Method	Reel
Packaging Quantity	2500

Other

Wire/Cable Type	Discrete Wire
Wire Type	Stranded
For Use With	Standard Universal MATE-N-LOK(Pin)



Product Compliance





[For compliance documentation, visit the product page on TE.com>](#)

EU RoHS Directive 2011/65/EU	Not Compliant
EU ELV Directive 2000/53/EC	Not Compliant
China RoHS 2 Directive MIIT Order No 32, 2016	Restricted Materials Above Threshold
EU REACH Regulation (EC) No. 1907/2006	Current ECHA Candidate List: JUNE 2022 (224) Candidate List Declared Against: JUNE 2022 (224) SVHC > Threshold: Pb (13% in Component Part) Article Safe Usage Statements: Do not eat, drink or smoke when using this product. Wash thoroughly after handling. Recycle if possible and dispose of the article by following all applicable governmental regulations relevant to your geographic location.
Halogen Content	Low Halogen - Br, Cl, F, I < 900 ppm per homogenous material. Also BFR/CFR/PVC Free
Solder Process Capability	Not applicable for solder process capability

Product Compliance Disclaimer

This information is provided based on reasonable inquiry of our suppliers and represents our current actual knowledge based on the information they provided. This information is subject to change. The part numbers that TE has identified as EU RoHS compliant have a maximum concentration of 0.1% by weight in homogenous materials for lead, hexavalent chromium, mercury, PBB, PBDE, DBP, BBP, DEHP, DIBP, and 0.01% for cadmium, or qualify for an exemption to these limits as defined in the Annexes of Directive 2011/65/EU (RoHS2). Finished electrical and electronic equipment products will be CE marked as required by Directive 2011/65/EU. Components may not be CE marked. Additionally, the part numbers that TE has identified as EU ELV compliant have a maximum concentration of 0.1% by weight in homogenous materials for lead, hexavalent chromium, and mercury, and 0.01% for cadmium, or qualify for an exemption to these limits as defined in the Annexes of Directive 2000/53/EC (ELV). Regarding the REACH Regulation, the information TE provides on SVHC in articles for this part number is based on the latest European Chemicals Agency (ECHA) 'Guidance on requirements for substances in articles' posted at this URL: <https://echa.europa.eu/guidance-documents/guidance-on-reach>

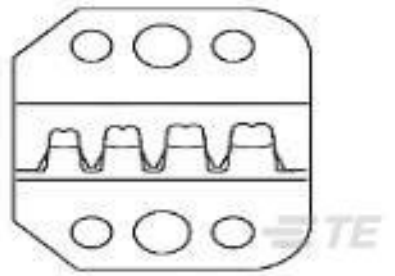
Compatible Parts

 <p>TE Part # 90547-1 ASSY PRO-CRIMPER UNIV M-N-L</p>	 <p>TE Part # 91506-1 CCII UNML UNML II PIN SKT 16-14 ASSY</p>	 <p>TE Part # 90547-2 PROCIMPER DIE ASSY UNIV MNL</p>	 <p>TE Part # 770022-1 12P UMNLII IN-LNE PLUG HSG KIT</p>
--	---	--	--



TE Part # 770019-1
04P UMNLI IN-LNE PLUG HSG KIT



TE Part # 770028-1
09P UMNLI IN-LINE CAP HSG KIT



TE Part # 770026-1
04P UMNLI IN-LINE CAP HSG KIT



TE Part # 770024-1
02P UMNLI IN-LINE CAP HSG KIT



TE Part # 770021-1
09P UMNLI IN-LNE PLUG HSG KIT



TE Part # 770030-1
15P UMNLI IN-LINE CAP HSG KIT



TE Part # 770018-1
03P UMNLI IN-LNE PLUG HSG KIT



TE Part # 770027-1
06P UMNLI IN-LINE CAP HSG KIT



TE Part # 770025-1
03P UMNLI IN-LINE CAP HSG KIT



TE Part # 770017-1
02P UMNLI IN-LNE PLUG HSG KIT



TE Part # 770020-1
06P UMNLI IN-LNE PLUG HSG KIT



TE Part # 770023-1
15P UMNLI IN-LNE PLUG HSG KIT



TE Part # 2305570-1
TERMINAL CUTTER, SIDE FEED



TE Part # 770016-1
05P UMNLI IN-LNE PLUG HSG KIT



TE Part # 770029-1
12P UMNLI IN-LINE CAP HSG KIT



TE Part # 91508-1
CCII UNML UNML II PIN SKT 20-18 ASSY

Also in the Series | **Universal MATE-N-LOK**



Circular Power Connectors(2)



Connector Contacts(11)



Insertion & Extraction Tools(4)



Power Contacts(207)

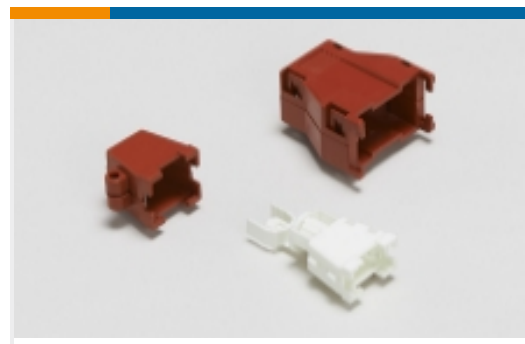

Rectangular Boots & Strain Relief(35)

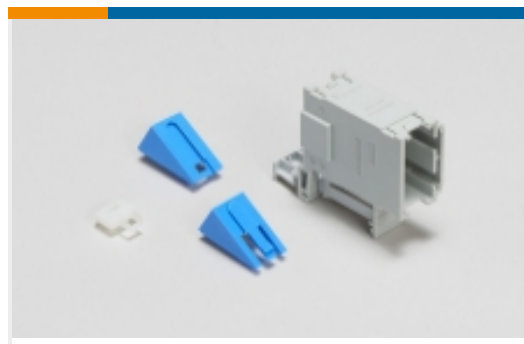

Rectangular Connector Adapters(7)



Rectangular Connector Hardware(1)



Rectangular Connector Housings(2)



Rectangular Connector Keying Plugs(3)



Rectangular Connector Locking(4)



Rectangular Connector Seals(26)



Rectangular Power Connectors(729)

Customers Also Bought



TE Part #320574
TERMINAL,PIDG R 16-14 10

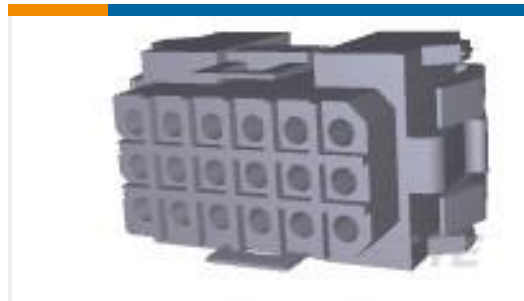

TE Part #207442-1
18 POS SQ GRID METRIMATE-PLUG



TE Part #350784-1
15P UMNL CAP HSG

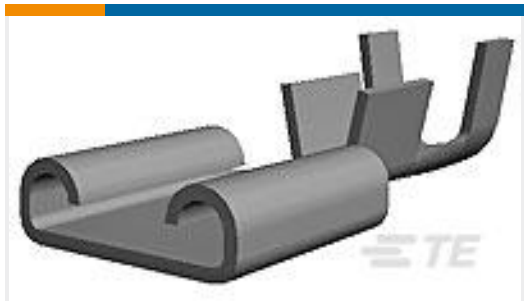

TE Part #6-160432-0
250 FASTON REC 20-16 AWG TPBZ



TE Part #350561-3
UMNL PIN 24-18 .0126 PTPPHBZ



TE Part #350218-3
UMNL PIN 20-14 .0125PTPPHBZ

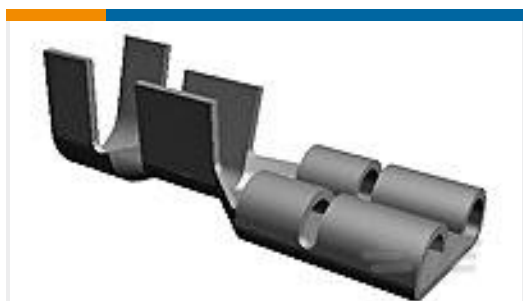

TE Part #280000-6
250 FASTON,REC.,24-17 AWG,TPBR



TE Part #180984
FASTON 250 BOOT FLAG NYLON NAT

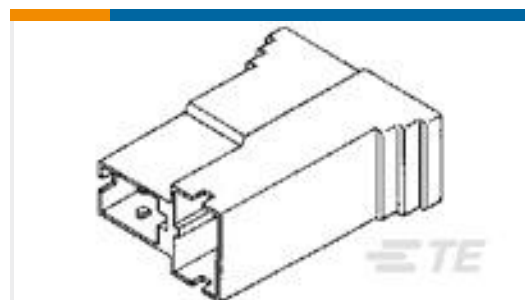

TE Part #926522-1
PL 250 REC HSG 2P NYLON BLACK

Documents



Product Drawings

[UMNL II SOK SN/AUNI/PHBZ](#)

English

CAD Files

[3D PDF](#)

3D

Customer View Model

[ENG_CVM_CVM_770006-4_S_c-770006-4-s.2d_dxf.zip](#)

English

Customer View Model

[ENG_CVM_CVM_770006-4_S_c-770006-4-s.3d_igs.zip](#)

English

Customer View Model

[ENG_CVM_CVM_770006-4_S_c-770006-4-s.3d_stp.zip](#)

English

By downloading the CAD file I accept and agree to the [Terms and Conditions](#) of use.

Datasheets & Catalog Pages

[SOFT_SHELL_PIN_SOCKET_CONNECTORS_STANDARD_DENSITY](#)

English

Product Specifications

[Application Specification](#)

English