

FEATURES SELECTION GUIDE

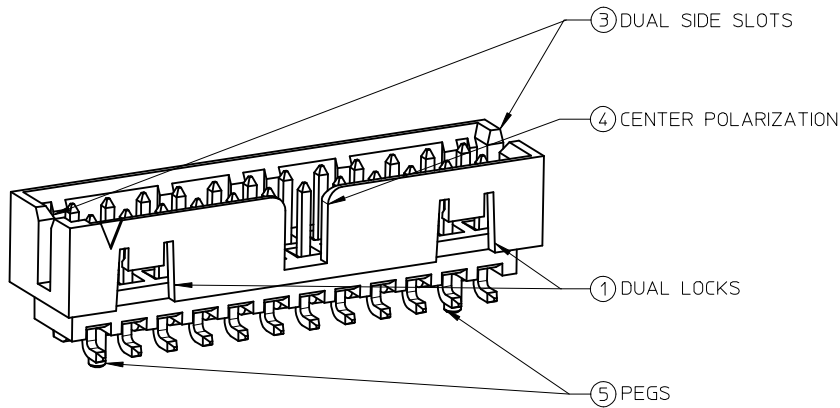
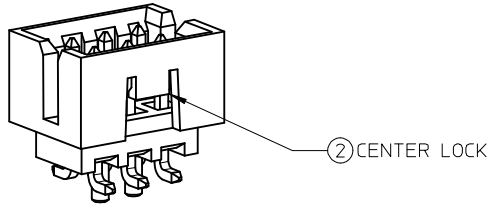

CIRCUIT SIZE	FEATURES					SHEET NO
	FRICTION LOCKS		③ DUAL SIDE SLOTS	④ CENTER POLARIZATION	⑤ PEGS	
	① DUAL	② CENTER				
4	N.A	N.A	YES	N.A	N.A	2 - 3
	N.A	YES	YES	N.A	N.A	
6	N.A	N.A	YES	N.A	N.A	4 - 5
	N.A	N.A	YES	N.A	YES	
	N.A	N.A	YES	YES	N.A	
	N.A	YES	YES	N.A	N.A	
	N.A	YES	YES	N.A	YES	
8 TO 12	N.A	N.A	YES	YES	YES	6 - 7
	N.A	N.A	YES	YES	N.A	
	N.A	YES	YES	N.A	YES	
14 TO 50	YES	N.A	YES	YES	N.A	8 - 11
	YES	N.A	YES	YES	YES	

RELEASED EC NO: S2015-1435 DRWG: GMENARLY 2015/05/22 CHK'D: CGOH 2015/09/21 APPR: KHL IM 2015/09/22	QUALITY SYMBOLS	GENERAL TOLERANCES (UNLESS SPECIFIED)		DIMENSION STYLE MM ONLY		SCALE NTS	DESIGN UNITS METRIC	THIRD ANGLE PROJECTION		
	$\nabla_{\text{A}}=0$ $\nabla_{\text{C}}=0$ $\nabla_{\text{P}}=0$	mm	INCH	DRAWN BY GMENARLY	DATE 2015/05/22	TITLE MILLIGRID 2MM PITCH, SMT VERTICAL SHROUDED HEADER				
		4 PLACES ± --- ± ---	3 PLACES ± --- ± ---	2 PLACES ± 0.20 ± ---	1 PLACE ± --- ± ---	0 PLACE ± --- ± ---	CHECKED BY CGOH	DATE 2015/09/21	APPROVED BY KHL IM	DATE 2015/09/22
		ANGULAR ± 3 °		DRAFT WHERE APPLICABLE MUST REMAIN WITHIN DIMENSIONS		MATERIAL NO. SEE TABLE		DOCUMENT NO. SD-87832-0001	SHEET NO. 1 OF 12	
THIS DRAWING CONTAINS INFORMATION THAT IS PROPRIETARY TO MOLEX INCORPORATED AND SHOULD NOT BE USED WITHOUT WRITTEN PERMISSION										

4 CIRCUITS

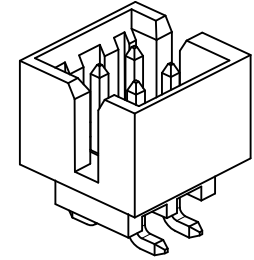
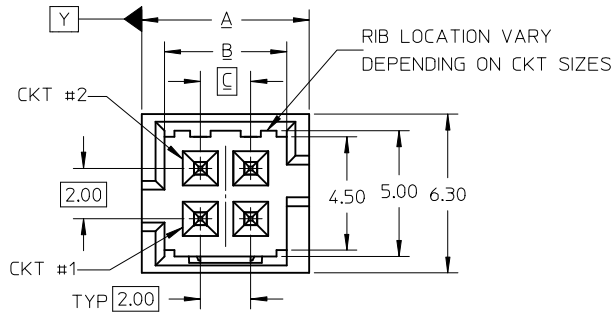

ISO VIEW OF HEADER WITH ONLY DUAL SLOTS

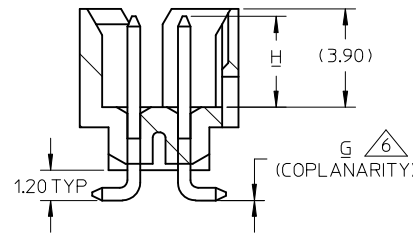
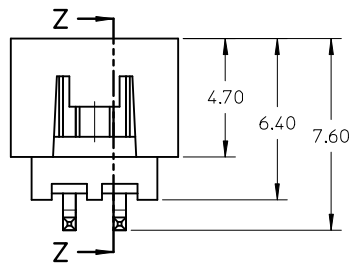

SECTION Z-Z

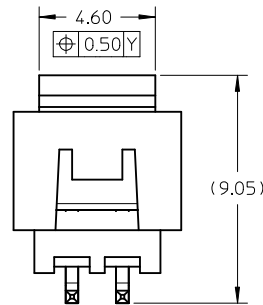
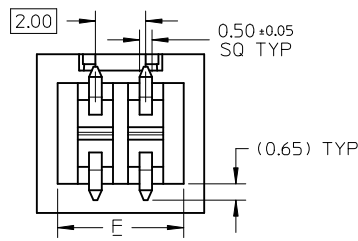

VIEW FOR HEADER WITH CAP

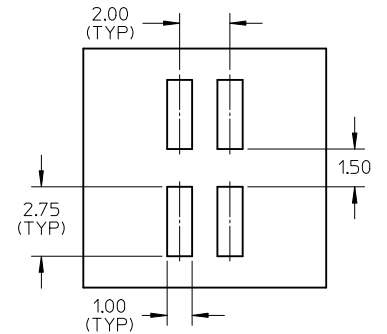
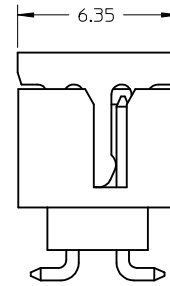

RECOMMENDED PCB LAYOUT

NOTES:

- MATERIALS:
HOUSING & CAP: 30% GF, NYLON, UL94V-0, COLOR: BLACK
PIN: 0.50MM SQ PHOSPHOR BRONZE
- FINISHES: REFER TO PLATING OPTIONS
- PRODUCT SPECIFICATION: PS-87831-027
- PACKAGING SPECIFICATION:
TUBE: PK-87831-001, TAPE AND REEL: PK-87831-300
- MATES WITH: A. MOLEX CRIMP RECEPTACLE HOUSING: 51110 SERIES AND CRIMP TERMINAL: 50394 SERIES
B. MOLEX 2MM MILLIGRID DUAL ROW IDT: 87568 SERIES
C. MOLEX 2MM MILLIGRID DUAL ROW RECEPTACLE: 79107 (GOLD PLATED), 78787 (TIN PLATED)

- COPLANARITY IS TO BE MEASURED BY RESTING THE SOLDER TAIL ON A GAUGE SURFACE
- BEND DEPRESSION ON SMT TAIL IS ACCEPTABLE SO LONG AS IT DOES NOT AFFECT THE OVERALL COPLANARITY
- TOP SURFACE OF CAP TO BE FLAT FOR THE PURPOSE OF PICK & PLACE BY VACUUM SUCTION NOZZLE

RELEASED EC NO: S2015-1435 DRWING: GMENARLY 2015/05/22 CHK'D: CGOH 2015/09/21 APPR: KHL IM 2015/09/22	QUALITY SYMBOLS $\nabla_A = 0$ $\nabla_G = 0$ $\nabla_P = 0$	GENERAL TOLERANCES (UNLESS SPECIFIED)		DIMENSION STYLE MM ONLY		SCALE NTS	DESIGN UNITS METRIC	THIRD ANGLE PROJECTION	
		mm	INCH	DRAWN BY	DATE	TITLE			
		4 PLACES ± --- ± ---	3 PLACES ± --- ± ---	GMENARLY	2015/05/22	MILLIGRID 2MM PITCH, SMT VERTICAL SHROUDED HEADER molex			
		2 PLACES ± 0.20 ± ---	1 PLACE ± --- ± ---	CGOH	2015/09/21				
0 PLACE ± --- ± ---	ANGULAR ± 3 °	DRAFT WHERE APPLICABLE MUST REMAIN WITHIN DIMENSIONS		SEE TABLE		DOCUMENT NO.		SHEET NO.	
				SIZE	THIS DRAWING CONTAINS INFORMATION THAT IS PROPRIETARY TO MOLEX INCORPORATED AND SHOULD NOT BE USED WITHOUT WRITTEN PERMISSION				

4 CIRCUITS

CKT SIZE	ASSY P/N WITHOUT CAP IN TUBE	ASSY P/N WITH CAP IN TUBE	ASSY P/N WITH CAP IN T&R	T&R OPTIONS (SEE SHEET 12)	PLATING OPTIONS	FRICTION LOCKS		DUAL SIDE SLOTS	CENTER POLARIZATION	PEGS	DIMENSION							
						DUAL	CENTER				A	B	C	D	E	F	G (COPLAN)	H
4	87832-0460	87832-0462	87832-5162	1	1	N.A	N.A	YES	N.A	N.A	6.65	4.85	2.00	N.A	N.A	5.00	0.10	3.60±0.20
	87832-0420	87832-0422	87832-5122	1	2													
	87832-0421	87832-0423	87832-5123	1	3													
	87832-0470	87832-0472	87832-5172	1	4	N.A	YES	YES	N.A	N.A							0.10	
	87832-0410	87832-0408	87832-0406	4	2													
	87832-0411	87832-0409	87832-0407	4	3	N.A	YES	YES	N.A	N.A							0.10	
87832-0404	N.A	N.A	N.A	2	N.A	YES	YES	N.A	N.A	0.10								

PLATING OPTIONS:

- 1 - 0.05-0.13um/2-5uin GOLD IN CONTACT AREA AND 1.88um/75uin MIN. MATTE TIN IN SOLDER TAIL AREA OVER 1.27um/50uin MIN. NICKEL OVERALL.
- 2 - 0.38um/15uin MIN. GOLD IN CONTACT AREA AND 1.88um/75uin MIN. MATTE TIN IN SOLDER TAIL AREA OVER 1.27um/50uin MIN. NICKEL OVERALL.
- 3 - 0.76um/30uin MIN. GOLD IN CONTACT AREA AND 1.88um/75uin MIN. MATTE TIN IN SOLDER TAIL AREA OVER 1.27um/50uin MIN. NICKEL OVERALL.
- 4 - 2.50um/100uin MIN. MATTE TIN OVER 1.25um/50uin MIN. NICKEL OVERALL.

RELEASED EC NO: S2015-1435 DRWN:GMENARLY 2015/05/22 CHKD:CGOH 2015/09/21 APPR:KHLIM 2015/09/22	DESCRIPTION QUALITY SYMBOLS $F_A=0$ $F_G=0$ $F_P=0$	GENERAL TOLERANCES (UNLESS SPECIFIED)		DIMENSION STYLE	SCALE	DESIGN UNITS	THIRD ANGLE PROJECTION	
				MM ONLY	NTS	METRIC		
				DRAWN BY	DATE	TITLE		
				CHECKED BY	DATE	MILLIGRID 2MM PITCH, SMT VERTICAL SHROUDED HEADER molex		
		APPROVED BY	DATE					
		MATERIAL NO.	DOCUMENT NO.	SHEET NO.				
		DRAFT WHERE APPLICABLE MUST REMAIN WITHIN DIMENSIONS		SEE TABLE	SD-87832-0001		3 OF 12	
		THIS DRAWING CONTAINS INFORMATION THAT IS PROPRIETARY TO MOLEX INCORPORATED AND SHOULD NOT BE USED WITHOUT WRITTEN PERMISSION						

6 CIRCUITS

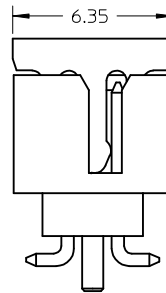
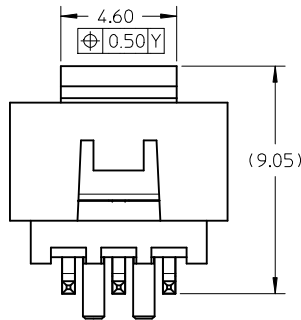
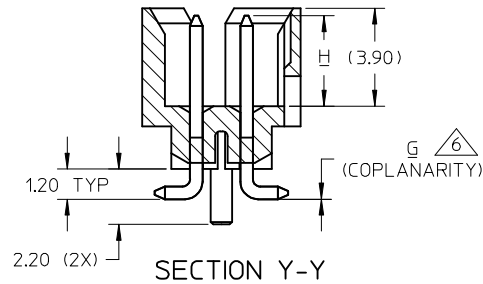
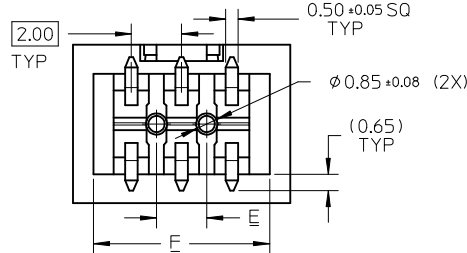
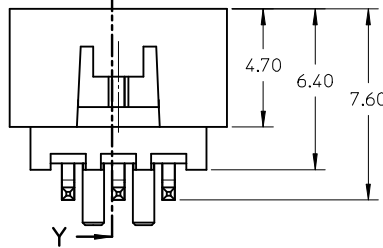
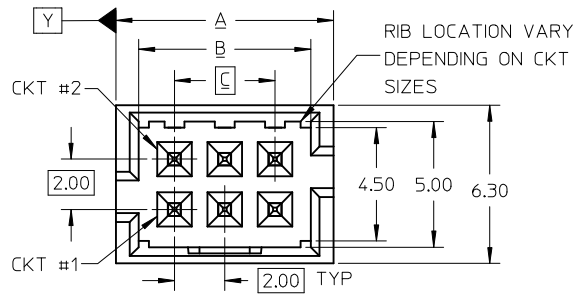

VIEW FOR HEADER WITH CAP

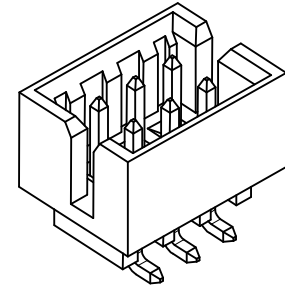

VIEW FOR HEADER WITH ONLY DUAL SLOTS

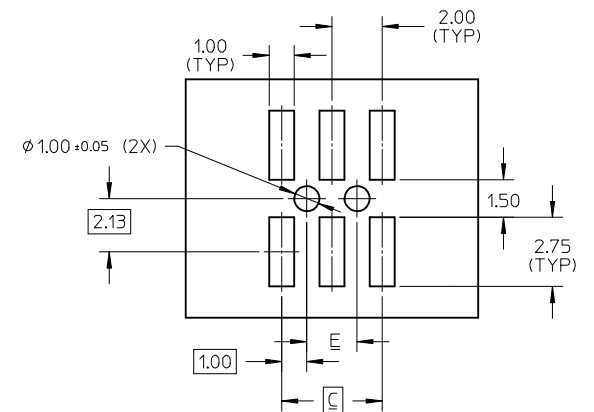

RECOMMENDED PCB LAYOUT

NOTES:

1. MATERIALS:
HOUSING & CAP: 30% GF, NYLON, UL94V-0, COLOR: BLACK
PIN: 0.50MM SQ PHOSPHOR BRONZE
2. FINISHES: REFER TO PLATING OPTIONS
3. PRODUCT SPECIFICATION: PS-87831-027
4. PACKAGING SPECIFICATION:
TUBE: PK-87831-001 . TAPE AND REEL: PK-87831-300
5. MATES WITH: A. MOLEX CRIMP RECEPTACLE HOUSING: 51110 SERIES AND CRIMP TERMINAL: 50394 SERIES
B. MOLEX 2MM MILLIGRID DUAL ROW IDT: 87568 SERIES
C. MOLEX 2MM MILLIGRID DUAL ROW RECEPTACLE: 79107 (GOLD PLATED), 78787 (TIN PLATED)

6. COPLANARITY IS TO BE MEASURED BY RESTING THE SOLDER TAIL ON A GAUGE SURFACE

7. BEND DEPRESSION ON SMT TAIL IS ACCEPTABLE SO LONG AS IT DOES NOT AFFECT THE OVERALL COPLANARITY
8. TOP SURFACE OF CAP TO BE FLAT FOR THE PURPOSE OF PICK & PLACE BY VACUUM SUCTION NOZZLE

RELEASED IEC NO: S2015-1435 DRAWN: GMENARLY 2015/05/22 CHECKED: CGOH 2015/09/21 APPR: KHLIM 2015/09/22	QUALITY SYMBOLS $\nabla F = 0$ $\nabla E = 0$ $\nabla F = 0$	GENERAL TOLERANCES (UNLESS SPECIFIED)		DIMENSION STYLE MM ONLY		SCALE NTS	DESIGN UNITS METRIC	THIRD ANGLE PROJECTION		
			mm	INCH	DRAWN BY GMENARLY	DATE 2015/05/22	TITLE MILLIGRID 2MM PITCH, SMT VERTICAL SHROUDED HEADER			
		4 PLACES	± ---	± ---	CHECKED BY CGOH	DATE 2015/09/21				
		3 PLACES	± ---	± ---	APPROVED BY KHLIM	DATE 2015/09/22				
2 PLACES	± 0.20	± ---	MATERIAL NO.		DOCUMENT NO.		SHEET NO.			
1 PLACE	± ---	± ---	ANGULAR ± 3 °		SD-87832-0001		4 OF 12			
0 PLACE	± ---	± ---	DRAFT WHERE APPLICABLE MUST REMAIN WITHIN DIMENSIONS		SEE TABLE		THIS DRAWING CONTAINS INFORMATION THAT IS PROPRIETARY TO MOLEX INCORPORATED AND SHOULD NOT BE USED WITHOUT WRITTEN PERMISSION			

6 CIRCUITS

CKT SIZE	ASSY P/N WITHOUT CAP IN TUBE	ASSY P/N WITH CAP IN TUBE	ASSY P/N WITH CAP IN T&R	T&R OPTIONS (SEE SHEET 12)	PLATING OPTIONS	FRICTION LOCKS		DUAL SIDE SLOTS	CENTER POLARIZATION	PEGS	DIMENSION							
						DUAL	CENTER				A	B	C	D	E	F	G (COPLAN)	H
6	87832-0660	87832-0662	87832-5262	1	1	N.A	N.A	YES	N.A	YES	8.65	6.85	4.00	N.A	2.00	7.00	0.10	3.60±0.20
	87832-0620	87832-0622	87832-5222	1	2													
	87832-0621	87832-0623	87832-5223	1	3													
	87832-0670	87832-0672	87832-5272	1	4	N.A	N.A	YES	N.A	N.A							0.10	3.60±0.20
	87832-0612	87832-0616	87832-0614	4	2													
	87832-0613	87832-0617	87832-0615	4	3	N.A	YES	YES	N.A	N.A							0.10	3.60±0.15
	87832-0624	87832-0626	87832-0628	4	2													
	87832-0625	87832-0627	87832-0629	4	3	N.A	YES	YES	N.A	YES							0.10	3.60±0.20
	87832-0610	87832-0608	87832-0606	4	2													
87832-0611	87832-0609	87832-0607	4	3	N.A	YES	YES	N.A	YES	0.10	3.60±0.20							
87832-0604	N.A	N.A	N.A	2														

PLATING OPTIONS:

- 1 - 0.05-0.13um/2-5uin GOLD IN CONTACT AREA AND 1.88um/75uin MIN. MATTE TIN IN SOLDER TAIL AREA OVER 1.27um/50uin MIN. NICKEL OVERALL.
- 2 - 0.38um/15uin MIN. GOLD IN CONTACT AREA AND 1.88um/75uin MIN. MATTE TIN IN SOLDER TAIL AREA OVER 1.27um/50uin MIN. NICKEL OVERALL.
- 3 - 0.76um/30uin MIN. GOLD IN CONTACT AREA AND 1.88um/75uin MIN. MATTE TIN IN SOLDER TAIL AREA OVER 1.27um/50uin MIN. NICKEL OVERALL.
- 4 - 2.50um/100uin MIN. MATTE TIN OVER 1.25um/50uin MIN. NICKEL OVERALL.

RELEASED EC NO: S2015-1435 DRWN:GMENARLY 2015/05/22 CHKD:CGOH 2015/09/21 APPR:KHL IM 2015/09/22	DESCRIPTION QUALITY SYMBOLS $F_A=0$ $F_G=0$ $F_P=0$	GENERAL TOLERANCES (UNLESS SPECIFIED)		DIMENSION STYLE MM ONLY		SCALE NTS	DESIGN UNITS METRIC	THIRD ANGLE PROJECTION		
			mm	INCH	DRAWN BY GMENARLY	DATE 2015/05/22	TITLE MILLIGRID 2MM PITCH, SMT VERTICAL SHROUDED HEADER molex DOCUMENT NO. SD-87832-0001 SHEET NO. 5 OF 12			
		4 PLACES	± ---	± ---	CHECKED BY CGOH	DATE 2015/09/21				
		3 PLACES	± ---	± ---	APPROVED BY KHL IM	DATE 2015/09/22				
2 PLACES	± 0.20	± ---	MATERIAL NO.							
1 PLACE	± ---	± ---	SEE TABLE		THIS DRAWING CONTAINS INFORMATION THAT IS PROPRIETARY TO MOLEX INCORPORATED AND SHOULD NOT BE USED WITHOUT WRITTEN PERMISSION					
0 PLACE	± ---	± ---	DRAFT WHERE APPLICABLE MUST REMAIN WITHIN DIMENSIONS							

8 TO 12 CIRCUITS

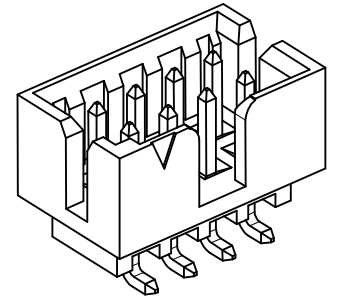
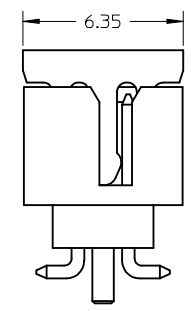
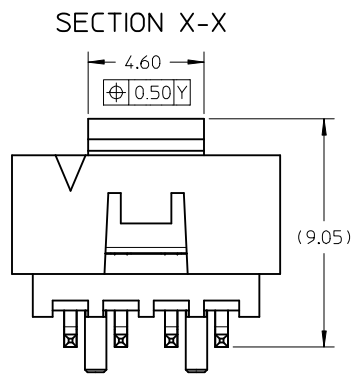
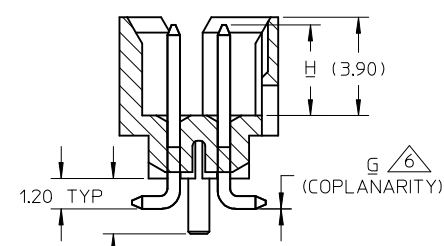
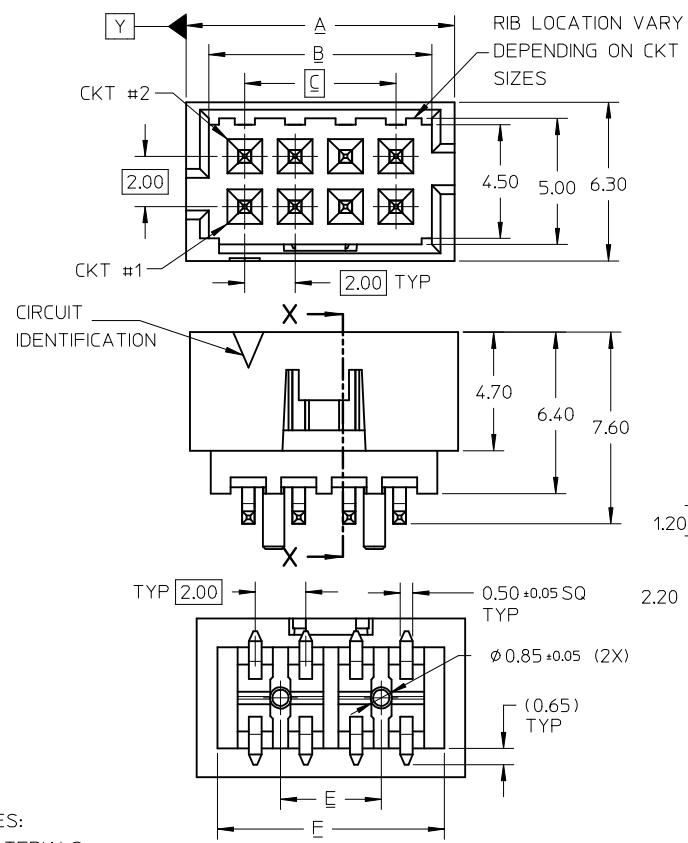

ISO VIEW OF HEADER WITH CENTER POLARIZATION AND DUAL SIDE SLOTS

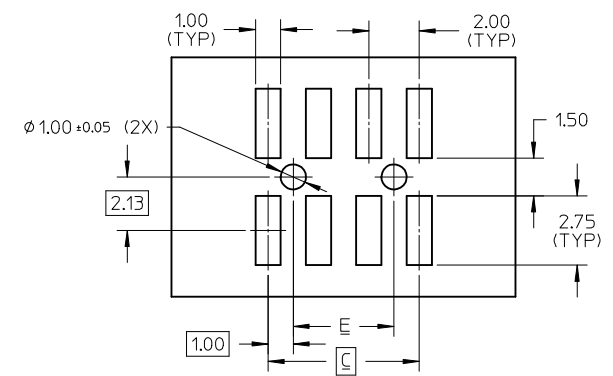

RECOMMENDED PCB LAYOUT

- NOTES:
- MATERIALS:
HOUSING & CAP: 30% GF, NYLON, UL94V-0, COLOR: BLACK
PIN: 0.50MM SQ PHOSPHOR BRONZE
 - FINISHES: REFER TO PLATING OPTIONS
 - PRODUCT SPECIFICATION: PS-87831-027
 - PACKAGING SPECIFICATION:
TUBE: PK-87831-001, TAPE AND REEL: PK-87831-300
 - MATES WITH: A. MOLEX CRIMP RECEPTACLE HOUSING: 51110 SERIES AND CRIMP TERMINAL: 50394 SERIES
B. MOLEX 2MM MILLIGRID DUAL ROW IDT: 87568 SERIES
C. MOLEX 2MM MILLIGRID DUAL ROW RECEPTACLE: 79107 (GOLD PLATED), 78787 (TIN PLATED)
 - COPLANARITY IS TO BE MEASURED BY RESTING THE SOLDER TAIL ON A GAUGE SURFACE
 - BEND DEPRESSION ON SMT TAIL IS ACCEPTABLE SO LONG AS IT DOES NOT AFFECT THE OVERALL COPLANARITY
 - TOP SURFACE OF CAP TO BE FLAT FOR THE PURPOSE OF PICK & PLACE BY VACUUM SUCTION NOZZLE

RELEASED EC NO: S2015-1435 DRWING: GMENARLY 2015/05/22 CHKD: CGOH 2015/09/21 APPR: KHL IM 2015/09/22	QUALITY SYMBOLS $F_A=0$ $F_G=0$ $F_P=0$	GENERAL TOLERANCES (UNLESS SPECIFIED)		DIMENSION STYLE MM ONLY		SCALE NTS	DESIGN UNITS METRIC	THIRD ANGLE PROJECTION	
		4 PLACES ± --- ± ---	mm INCH	DRAWN BY GMENARLY	DATE 2015/05/22	TITLE MILLIGRID 2MM PITCH, SMT VERTICAL SHROUDED HEADER			
		3 PLACES ± --- ± ---		CHECKED BY CGOH	DATE 2015/09/21	molex			
		2 PLACES ± 0.20 ± ---		APPROVED BY KHL IM	DATE 2015/09/22				
1 PLACE ± --- ± ---		MATERIAL NO.		SEE TABLE		DOCUMENT NO. SD-87832-0001	SHEET NO. 6 OF 12		
0 PLACE ± --- ± ---		ANGULAR ± 3 °		THIS DRAWING CONTAINS INFORMATION THAT IS PROPRIETARY TO MOLEX INCORPORATED AND SHOULD NOT BE USED WITHOUT WRITTEN PERMISSION					
DRAFT WHERE APPLICABLE MUST REMAIN WITHIN DIMENSIONS									

8 TO 12 CIRCUITS

F	CKT SIZE	ASSY P/N WITHOUT CAP IN TUBE	ASSY P/N WITH CAP IN TUBE	ASSY P/N WITH CAP IN T&R	T&R OPTIONS (SEE SHEET 12)	PLATING OPTIONS	FRICTION LOCKS		DUAL SIDE SLOTS	CENTER POLARIZATION	PEGS	DIMENSION										
							DUAL	CENTER				A	B	C	D	E	F	G (COPLAN)	H			
E	8	87832-0860	87832-0862	87832-5362	1	1	N.A	N.A	YES	YES	YES	10.65	8.85	6.00	N.A	4.00	9.00	0.10	3.60±0.20			
		87832-0820	87832-0822	87832-5322	1	2																
		87832-0821	87832-0823	87832-5323	1	3																
		87832-0870	87832-0872	87832-5372	1	4																
		87832-0812	87832-0816	87832-0814	4	2	N.A	N.A	YES	YES	N.A							N.A	4.00	9.00	0.10	3.60±0.20
		87832-0824	87832-0826	87832-0828	4	2	N.A	YES	YES	N.A	N.A											
		87832-0825	87832-0827	87832-0829	4	3	N.A	YES	YES	N.A	YES											
		87832-0810	87832-0808	87832-0806	4	2	N.A	YES	YES	N.A	YES											
87832-0811	87832-0809	87832-0807	4	3	N.A	YES	YES	N.A	YES													
87832-0804	N.A	N.A	N.A	2	N.A	YES	YES	N.A	YES													
D	10	87832-1060	87832-1062	87832-5462	1	1	N.A	N.A	YES	YES	YES	12.65	10.85	8.00	N.A	6.00	11.00	0.10	3.60±0.20			
		87832-1020	87832-1022	87832-5422	1	2																
		87832-1021	87832-1023	87832-5423	1	3																
				87832-9423	2																	
		87832-1070	87832-1072	87832-5472	1	4	N.A	N.A	YES	YES	N.A							N.A	6.00	11.00	0.10	3.60±0.20
		87832-1012	87832-1016	87832-1014	4	2	N.A	YES	YES	N.A	N.A											
		87832-1024	87832-1026	87832-1028	4	2	N.A	YES	YES	N.A	N.A											
		87832-1025	87832-1027	87832-1029	4	3	N.A	YES	YES	N.A	YES											
		87832-1010	87832-1008	87832-1006	4	2	N.A	YES	YES	N.A	YES											
		87832-1011	87832-1009	87832-1007	4	3	N.A	YES	YES	N.A	YES											
87832-1004	N.A	N.A	N.A	2	N.A	YES	YES	N.A	YES													
C	12	87832-1260	87832-1262	87832-5562	1	1	N.A	N.A	YES	YES	YES	14.65	12.85	10.00	N.A	8.00	13.00	0.10	3.60±0.20			
		87832-1220	87832-1222	87832-5522	1	2																
		87832-1221	87832-1223	87832-5523	1	3																
		87832-1270	87832-1272	87832-5572	1	4	N.A	YES	YES	N.A	N.A							N.A	8.00	13.00	0.10	3.60±0.15
		87832-1224	87832-1226	87832-1228	1	2	N.A	YES	YES	N.A	N.A											
		87832-1225	87832-1227	87832-1229	1	3	N.A	YES	YES	N.A	YES											
		87832-1210	87832-1208	87832-1206	1	2	N.A	YES	YES	N.A	YES											
		87832-1211	87832-1209	87832-1207	1	3	N.A	YES	YES	N.A	YES											
87832-1204	N.A	N.A	N.A	2	N.A	YES	YES	N.A	YES													

PLATING OPTIONS:

- 0.05-0.13um/2-5uin GOLD IN CONTACT AREA AND 1.88um/75uin MIN. MATTE TIN IN SOLDER TAIL AREA OVER 1.27um/50uin MIN. NICKEL OVERALL.
- 0.38um/15uin MIN. GOLD IN CONTACT AREA AND 1.88um/75uin MIN. MATTE TIN IN SOLDER TAIL AREA OVER 1.27um/50uin MIN. NICKEL OVERALL.
- 0.76um/30uin MIN. GOLD IN CONTACT AREA AND 1.88um/75uin MIN. MATTE TIN IN SOLDER TAIL AREA OVER 1.27um/50uin MIN. NICKEL OVERALL.
- 2.50um/100uin MIN. MATTE TIN OVER 1.25um/50uin MIN. NICKEL OVERALL.

RELEASED EC NO: S2015-1435 DRWING: MEMARLY 2015/05/22 CHK'D: CGOH 2015/09/21 APPR: KHL IM 2015/09/22	QUALITY SYMBOLS $F_A=0$ $F_B=0$ $F_C=0$	GENERAL TOLERANCES (UNLESS SPECIFIED)		DIMENSION STYLE		SCALE	DESIGN UNITS	THIRD ANGLE PROJECTION			
				MM ONLY		NTS	METRIC				
				mm	INCH	DRAWN BY	DATE	TITLE			
				4 PLACES ± --- ± ---		GMENARLY	2015/05/22	MILLIGRID 2MM PITCH, SMT VERTICAL SHROUDED HEADER molex			
				3 PLACES ± --- ± ---		CHECKED BY	DATE				
		2 PLACES ± 0.20 ± ---		CGOH	2015/09/21	DOCUMENT NO. SD-87832-0001					
		1 PLACE ± --- ± ---		APPROVED BY	DATE	SHEET NO. 7 OF 12					
		0 PLACE ± --- ± ---		KHL IM	2015/09/22	THIS DRAWING CONTAINS INFORMATION THAT IS PROPRIETARY TO MOLEX INCORPORATED AND SHOULD NOT BE USED WITHOUT WRITTEN PERMISSION					
		ANGULAR ± 3 °		MATERIAL NO.		SEE TABLE					
		DRAFT WHERE APPLICABLE MUST REMAIN WITHIN DIMENSIONS		SIZE A3							

14 TO 50 CIRCUITS

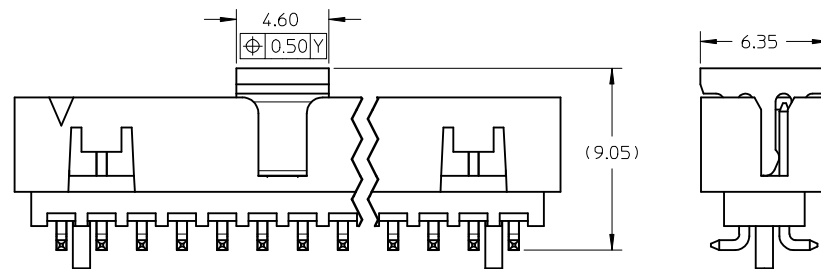
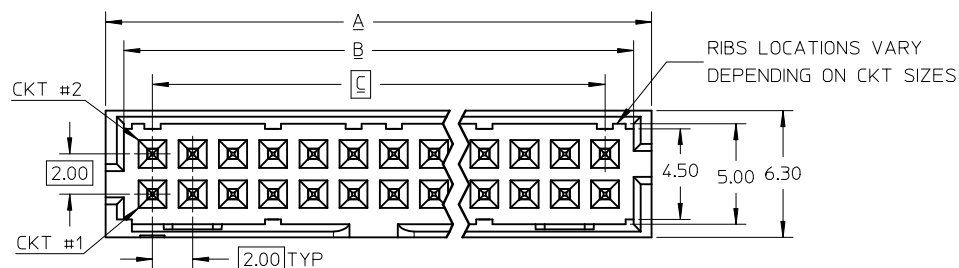

VIEW FOR HEADER WITH CAP

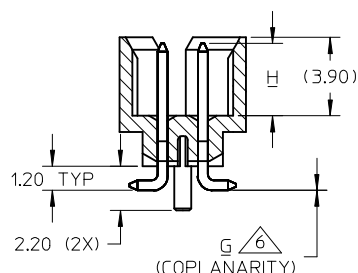
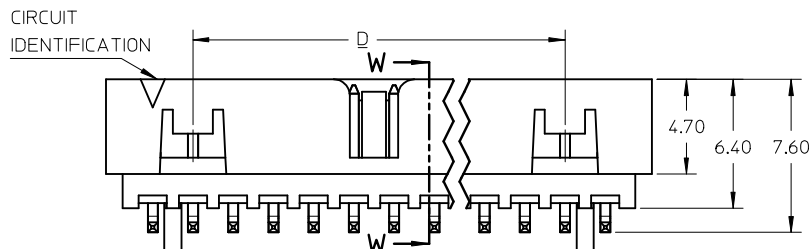

SECTION W-W

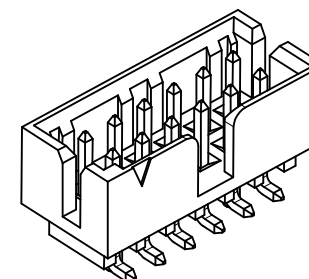

ISO VIEW OF HEADER WITH CENTER POLARIZATION AND DUAL SIDE SLOTS

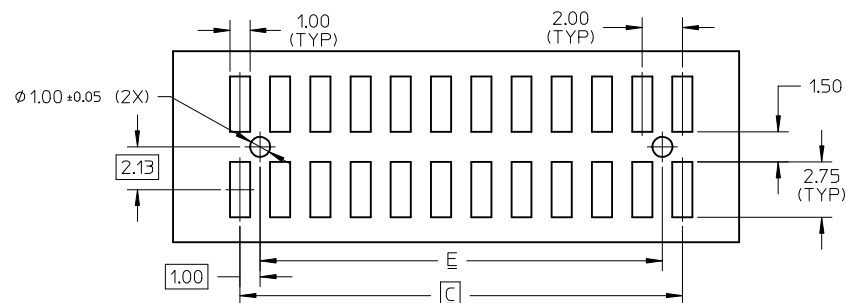
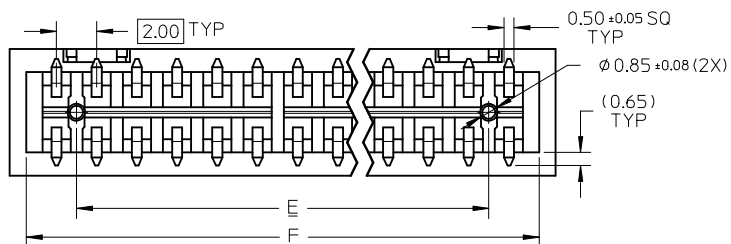

RECOMMENDED PCB LAYOUT

NOTES:

- MATERIALS:
HOUSING & CAP: 30% GF, NYLON, UL94V-0, COLOR: BLACK
PIN: 0.50MM SQ PHOSPHOR BRONZE
- FINISHES: REFER TO PLATING OPTIONS
- PRODUCT SPECIFICATION: PS-87831-027
- PACKAGING SPECIFICATION:
TUBE: PK-87831-001, TAPE AND REEL: PK-87831-300
- MATES WITH: A. MOLEX CRIMP RECEPTACLE HOUSING: 51110 SERIES AND CRIMP TERMINAL: 50394 SERIES
B. MOLEX 2MM MILLIGRID DUAL ROW IDT: 87568 SERIES
C. MOLEX 2MM MILLIGRID DUAL ROW RECEPTACLE: 79107 (GOLD PLATED), 78787 (TIN PLATED)

6. COPLANARITY IS TO BE MEASURED BY RESTING THE SOLDER TAIL ON A GAUGE SURFACE

- BEND DEPRESSION ON SMT TAIL IS ACCEPTABLE SO LONG AS IT DOES NOT AFFECT THE OVERALL COPLANARITY
- TOP SURFACE OF CAP TO BE FLAT FOR THE PURPOSE OF PICK & PLACE BY VACUUM SUCTION NOZZLE

RELEASED EC NO: S2015-1435 DRWN:GMENARLY 2015/05/22 CHKD:CGOH 2015/09/21 APPR:KHL IM 2015/09/22	DESCRIPTION QUALITY SYMBOLS $F_A=0$ $F_G=0$ $F_P=0$	GENERAL TOLERANCES (UNLESS SPECIFIED)		DIMENSION STYLE MM ONLY		SCALE NTS	DESIGN UNITS METRIC	THIRD ANGLE PROJECTION		
		mm	INCH	DRAWN BY	DATE	TITLE				
		4 PLACES ± --- ± ---	3 PLACES ± --- ± ---	2 PLACES ± 0.20 ± ---	1 PLACE ± --- ± ---	0 PLACE ± --- ± ---	GMENARLY	2015/05/22	MILLIGRID 2MM PITCH, SMT VERTICAL SHROUDED HEADER	
		ANGULAR ± 3 °					CGOH	2015/09/21	molex	
A	REV	DRAFT WHERE APPLICABLE MUST REMAIN WITHIN DIMENSIONS		MATERIAL NO. SEE TABLE	DATE 2015/09/22	DOCUMENT NO. SD-87832-0001	SHEET NO. 8 OF 12	THIS DRAWING CONTAINS INFORMATION THAT IS PROPRIETARY TO MOLEX INCORPORATED AND SHOULD NOT BE USED WITHOUT WRITTEN PERMISSION		

14 TO 24 CIRCUITS

CKT SIZE	ASSY P/N WITHOUT CAP IN TUBE	ASSY P/N WITH CAP IN TUBE	ASSY P/N WITH CAP IN T&R	T&R OPTIONS (SEE SHEET 12)	PLATING OPTIONS	FRICTION LOCKS		DUAL SIDE SLOTS	CENTER POLARIZATION	PEGS	DIMENSION																				
						DUAL	CENTER				A	B	C	D	E	F	G (COPLAN)	H													
14	87832-1460	87832-1462	87832-5662	1	1	YES	N.A	YES	YES	YES	16.65	14.85	12.00	8.00	10.00	15.00	0.15	3.60±0.20													
	87832-1420	87832-1422	87832-5622	1	2																										
	87832-1421	87832-1423	87832-5623	1	3																										
			87832-9523	2																											
	87832-1470	87832-1472	87832-5672	1	4																										
87832-1412	87832-1416	87832-1414	1	2	YES	N.A	YES	YES	N.A							0.15	3.60±0.20														
16	87832-1660	87832-1662	87832-5762	1	1	YES	N.A	YES	YES	YES	18.65	16.85	14.00	10.00	12.00	17.00	0.15	3.60±0.20													
	87832-1620	87832-1622	87832-5722	1	2																										
	87832-1621	87832-1623	87832-5723	1	3																										
	87832-1670	87832-1672	87832-5772	1	4																										
	87832-1612	87832-1616	87832-1614	1	2														YES	N.A	YES	YES	N.A							0.15	3.60±0.20
18	87832-1860	87832-1862	87832-5862	1	1	YES	N.A	YES	YES	YES	20.65	18.85	16.00	12.00	14.00	19.00	0.15	3.60±0.20													
	87832-1820	87832-1822	87832-5822	1	2																										
	87832-1821	87832-1823	87832-5823	1	3																										
	87832-1870	87832-1872	87832-5872	1	4																										
	87832-1812	87832-1816	87832-1814	3	2														YES	N.A	YES	YES	N.A							0.15	3.60±0.20
	87832-1813	87832-1817	87832-1815	3	3														YES	N.A	YES	YES	N.A								0.15
20	87832-2060	87832-2062	87832-5962	1	1	YES	N.A	YES	YES	YES	22.65	20.85	18.00	14.00	16.00	21.00	0.15	3.60±0.20													
	87832-2020	87832-2022	87832-5922	1	2																										
	87832-2021	87832-2023	87832-5923	1	3																										
	87832-2070	87832-2072	87832-5972	1	4																										
	87832-2012	87832-2016	87832-2014	1	2														YES	N.A	YES	YES	N.A							0.15	3.60±0.20
22	87832-2260	87832-2262	87832-6062	1	1	YES	N.A	YES	YES	YES	24.65	22.85	20.00	16.00	18.00	23.00	0.15	3.60±0.20													
	87832-2220	87832-2222	87832-6022	1	2																										
	87832-2221	87832-2223	87832-6023	1	3																										
	87832-2270	87832-2272	87832-6072	1	4																										
24	87832-2460	87832-2462	87832-6162	1	1	YES	N.A	YES	YES	YES	26.65	24.85	22.00	18.00	20.00	25.00	0.15	3.60±0.20													
	87832-2420	87832-2422	87832-6122	1	2																										
	87832-2421	87832-2423	87832-6123	1	3																										
	87832-2470	87832-2472	87832-6172	1	4																										
	87832-2412	87832-2416	87832-2414	1	2														YES	N.A	YES	YES	N.A							0.15	3.60±0.20

PLATING OPTIONS:

- 1 - 0.05-0.13um/2-5uin GOLD IN CONTACT AREA AND 1.88um/75uin MIN. MATTE TIN IN SOLDER TAIL AREA OVER 1.27um/50uin MIN. NICKEL OVERALL.
- 2 - 0.38um/15uin MIN. GOLD IN CONTACT AREA AND 1.88um/75uin MIN. MATTE TIN IN SOLDER TAIL AREA OVER 1.27um/50uin MIN. NICKEL OVERALL.
- 3 - 0.76um/30uin MIN. GOLD IN CONTACT AREA AND 1.88um/75uin MIN. MATTE TIN IN SOLDER TAIL AREA OVER 1.27um/50uin MIN. NICKEL OVERALL.
- 4 - 2.50um/100uin MIN. MATTE TIN OVER 1.25um/50uin MIN. NICKEL OVERALL.

RELEASED EC NO: S2015-1435 DRWG:GMENARLY 2015/05/22 CHKD:CGOH 2015/09/21 APPR:KHLIM 2015/09/22	DESCRIPTION REV	QUALITY SYMBOLS	GENERAL TOLERANCES (UNLESS SPECIFIED)	DIMENSION STYLE	SCALE	DESIGN UNITS	THIRD ANGLE PROJECTION		
		$F_A=0$ $F_G=0$ $F_P=0$	mm INCH 4 PLACES ± --- ± --- 3 PLACES ± --- ± --- 2 PLACES ± 0.20 ± --- 1 PLACE ± --- ± --- 0 PLACE ± --- ± ---	MM ONLY	NTS	METRIC	DRAWN BY: GMENARLY DATE: 2015/05/22 CHECKED BY: CGOH DATE: 2015/09/21 APPROVED BY: KHLIM DATE: 2015/09/22	TITLE MILLIGRID 2MM PITCH, SMT VERTICAL SHROUDED HEADER 	
			ANGULAR ± 3 °	SEE TABLE			MATERIAL NO.	DOCUMENT NO.	SHEET NO.
			DRAFT WHERE APPLICABLE MUST REMAIN WITHIN DIMENSIONS				THIS DRAWING CONTAINS INFORMATION THAT IS PROPRIETARY TO MOLEX INCORPORATED AND SHOULD NOT BE USED WITHOUT WRITTEN PERMISSION		9 OF 12

26 TO 38 CIRCUITS

CKT SIZE	ASSY P/N WITHOUT CAP IN TUBE	ASSY P/N WITH CAP IN TUBE	ASSY P/N WITH CAP IN T&R	T&R OPTIONS (SEE SHEET 12)	PLATING OPTIONS	FRICTION LOCKS		DUAL SIDE SLOTS	CENTER POLARIZATION	PEGS	DIMENSION							
						DUAL	CENTER				A	B	C	D	E	F	G (COPLAN)	H
26	87832-2660	87832-2662	87832-6262	1	1	YES	N.A	YES	YES	YES	28.65	26.85	24.00	20.00	22.00	27.00	0.15	3.60±0.20
	87832-2620	87832-2622	87832-6222	1	2													
	87832-2621	87832-2623	87832-6223	1	3													
	87832-2670	87832-2672	87832-6272	1	4													
	87832-2612	87832-2616	N.A	N.A	2												YES	N.A
28	87832-2860	87832-2862	87832-6362	1	1	YES	N.A	YES	YES	YES	30.65	28.85	26.00	22.00	24.00	29.00	0.15	3.60±0.20
	87832-2820	87832-2822	87832-6322	1	2													
	87832-2821	87832-2823	87832-6323	1	3													
	87832-2870	87832-2872	87832-6372	1	4													
30	87832-3060	87832-3062	87832-6462	1	1	YES	N.A	YES	YES	YES	32.65	30.85	28.00	24.00	26.00	31.00	0.15	3.60±0.20
	87832-3020	87832-3022	87832-6422	1	2													
	87832-3021	87832-3023	87832-6423	1	3													
	87832-3070	87832-3072	87832-6472	1	4													
	87832-3012	87832-3016	87832-3014	3	2												YES	N.A
32	87832-3260	87832-3262	87832-6562	1	1	YES	N.A	YES	YES	YES	34.65	32.85	30.00	26.00	28.00	33.00	0.15	3.60±0.20
	87832-3220	87832-3222	87832-6522	1	2													
	87832-3221	87832-3223	87832-6523	1	3													
	87832-3270	87832-3272	87832-6572	1	4													
34	87832-3460	87832-3462	87832-6662	1	1	YES	N.A	YES	YES	YES	36.65	34.85	32.00	28.00	30.00	35.00	0.15	3.60±0.20
	87832-3420	87832-3422	87832-6622	1	2													
	87832-3421	87832-3423	87832-6623	1	3													
	87832-3470	87832-3472	87832-6672	1	4													
	87832-3412	87832-3416	87832-3414	3	2												YES	N.A
36	87832-3660	87832-3662	N.A	N.A	1	YES	N.A	YES	YES	YES	38.65	36.85	34.00	30.00	32.00	37.00	0.15	3.60±0.20
	87832-3620	87832-3622	N.A	N.A	2													
	87832-3621	87832-3623	N.A	N.A	3													
	87832-3670	87832-3672	N.A	N.A	4													
38	87832-3860	87832-3862	N.A	N.A	1	YES	N.A	YES	YES	YES	40.65	38.85	36.00	32.00	34.00	39.00	0.15	3.60±0.20
	87832-3820	87832-3822	N.A	N.A	2													
	87832-3821	87832-3823	N.A	N.A	3													
	87832-3870	87832-3872	N.A	N.A	4													

PLATING OPTIONS:

- 1 - 0.05-0.13um/2-5uin GOLD IN CONTACT AREA AND 1.88um/75uin MIN. MATTE TIN IN SOLDER TAIL AREA OVER 1.27um/50uin MIN. NICKEL OVERALL.
- 2 - 0.38um/15uin MIN. GOLD IN CONTACT AREA AND 1.88um/75uin MIN. MATTE TIN IN SOLDER TAIL AREA OVER 1.27um/50uin MIN. NICKEL OVERALL.
- 3 - 0.76um/30uin MIN. GOLD IN CONTACT AREA AND 1.88um/75uin MIN. MATTE TIN IN SOLDER TAIL AREA OVER 1.27um/50uin MIN. NICKEL OVERALL.
- 4 - 2.50um/100uin MIN. MATTE TIN OVER 1.25um/50uin MIN. NICKEL OVERALL.

RELEASED	EC NO: S2015-1435	2015/05/22	DESCRIPTION
	DRWN:GMENARLY	2015/09/21	
	CHKD:CGOH	2015/09/21	
	APPR:KHLIM	2015/09/22	

QUALITY SYMBOLS	GENERAL TOLERANCES (UNLESS SPECIFIED)	
	mm	INCH
$F_{\sigma} = 0$	4 PLACES ± --- ± ---	
$F_{\sigma} = 0$	3 PLACES ± --- ± ---	
$F_{\sigma} = 0$	2 PLACES ± 0.20 ± ---	
	1 PLACE ± --- ± ---	
	0 PLACE ± --- ± ---	
	ANGULAR ± 3 °	
	DRAFT WHERE APPLICABLE MUST REMAIN WITHIN DIMENSIONS	

DIMENSION STYLE		SCALE	DESIGN UNITS	THIRD ANGLE PROJECTION
MM ONLY		NTS	METRIC	
DRAWN BY	DATE	TITLE		
GMENARLY	2015/05/22	MILLIGRID 2MM PITCH, SMT VERTICAL SHROUDED HEADER		
CHECKED BY	DATE			
CGOH	2015/09/21	molex		
APPROVED BY	DATE			
KHLIM	2015/09/22	MATERIAL NO.	DOCUMENT NO.	SHEET NO.
		SEE TABLE	SD-87832-0001	10 OF 12

THIS DRAWING CONTAINS INFORMATION THAT IS PROPRIETARY TO MOLEX INCORPORATED AND SHOULD NOT BE USED WITHOUT WRITTEN PERMISSION

40 TO 50 CIRCUITS

CKT SIZE	ASSY P/N WITHOUT CAP IN TUBE	ASSY P/N WITH CAP IN TUBE	ASSY P/N WITH CAP IN T&R	T&R OPTIONS (SEE SHEET 12)	PLATING OPTIONS	FRICTION LOCKS		DUAL SIDE SLOTS	CENTER POLARIZATION	PEGS	DIMENSION							
						DUAL	CENTER				A	B	C	D	E	F	G (COPLAN)	H
40	87832-4060	87832-4062	87832-6962	1	1													
	87832-4020	87832-4022	87832-6922	1	2													
	87832-4021	87832-4023	87832-6923	1	3	YES	N.A	YES	YES	YES	42.65	40.85	38.00	34.00	36.00	41.00	0.15	3.60±0.20
	87832-4070	87832-4072	87832-6972	1	4													
	87832-4012	87832-4016	N.A	N.A	2	YES	N.A	YES	YES	N.A							0.15	3.60±0.20
42	87832-4260	87832-4262	N.A	N.A	1													
	87832-4220	87832-4222	N.A	N.A	2	YES	N.A	YES	YES	YES	44.65	42.85	40.00	36.00	38.00	43.00	0.15	3.60±0.20
	87832-4221	87832-4223	N.A	N.A	3													
	87832-4270	87832-4272	N.A	N.A	4													
44	87832-4460	87832-4462	87832-7162	1	1													
	87832-4420	87832-4422	87832-7122	1	2													
	87832-4421	87832-4423	87832-7123	1	3	YES	N.A	YES	YES	YES	46.65	44.85	42.00	38.00	40.00	45.00	0.15	3.60±0.20
	87832-4470	87832-4472	87832-7172	1	4													
	87832-4413	87832-4417	87832-4415	3	3	YES	N.A	YES	YES	N.A							0.15	3.60±0.20
46	87832-4660	87832-4662	87832-7262	1	1													
	87832-4620	87832-4622	87832-7222	1	2													
	87832-4621	87832-4623	N.A	N.A	3	YES	N.A	YES	YES	YES	48.65	46.85	44.00	40.00	42.00	47.00	0.15	3.60±0.20
	87832-4670	87832-4672	87832-7272	1	4													
48	87832-4860	87832-4862	N.A	N.A	1													
	87832-4820	87832-4822	N.A	N.A	2													
	87832-4821	87832-4823	N.A	N.A	3	YES	N.A	YES	YES	YES	50.65	48.85	46.00	42.00	44.00	49.00	0.15	3.60±0.20
	87832-4870	87832-4872	N.A	N.A	4													
50	87832-5060	87832-5062	87832-7462	1	1													
	87832-5020	87832-5022	87832-7422	1	2													
	87832-5021	87832-5023	87832-7423	1	3	YES	N.A	YES	YES	YES	52.65	50.85	48.00	44.00	46.00	51.00	0.15	3.60±0.20
	87832-5070	87832-5072	87832-7472	1	4													
	87832-5012	87832-5016	N.A	N.A	2	YES	N.A	YES	YES	N.A							0.15	3.60±0.20

PLATING OPTIONS:

- 1 - 0.05-0.13um/2-5uin GOLD IN CONTACT AREA AND 1.88um/75uin MIN. MATTE TIN IN SOLDER TAIL AREA OVER 1.27um/50uin MIN. NICKEL OVERALL.
- 2 - 0.38um/15uin MIN. GOLD IN CONTACT AREA AND 1.88um/75uin MIN. MATTE TIN IN SOLDER TAIL AREA OVER 1.27um/50uin MIN. NICKEL OVERALL.
- 3 - 0.76um/30uin MIN. GOLD IN CONTACT AREA AND 1.88um/75uin MIN. MATTE TIN IN SOLDER TAIL AREA OVER 1.27um/50uin MIN. NICKEL OVERALL.
- 4 - 2.50um/100uin MIN. MATTE TIN OVER 1.25um/50uin MIN. NICKEL OVERALL.

RELEASED EC NO: S2015-1435 DRWING:GMENARLY 2015/05/22 CHKD:CGOH 2015/09/21 APPR:KHL IM 2015/09/22	DESCRIPTION QUALITY SYMBOLS $F_A=0$ $F_G=0$ $F_P=0$	GENERAL TOLERANCES (UNLESS SPECIFIED)		DIMENSION STYLE MM ONLY		SCALE NTS	DESIGN UNITS METRIC	THIRD ANGLE PROJECTION		
			mm	INCH	DRAWN BY GMENARLY	DATE 2015/05/22	TITLE MILLIGRID 2MM PITCH, SMT VERTICAL SHROUDED HEADER			
			4 PLACES ± --- ± ---	3 PLACES ± --- ± ---	CHECKED BY CGOH	DATE 2015/09/21	 DOCUMENT NO. SD-87832-0001 SHEET NO. 11 OF 12			
			2 PLACES ± 0.20 ± ---	1 PLACE ± --- ± ---	APPROVED BY KHL IM	DATE 2015/09/22				
	0 PLACE ± --- ± ---	ANGULAR ± 3 °		MATERIAL NO.		SEE TABLE		THIS DRAWING CONTAINS INFORMATION THAT IS PROPRIETARY TO MOLEX INCORPORATED AND SHOULD NOT BE USED WITHOUT WRITTEN PERMISSION		
	DRAFT WHERE APPLICABLE MUST REMAIN WITHIN DIMENSIONS		SIZE A3							

PACKAGING OPTIONS

OPTION 1

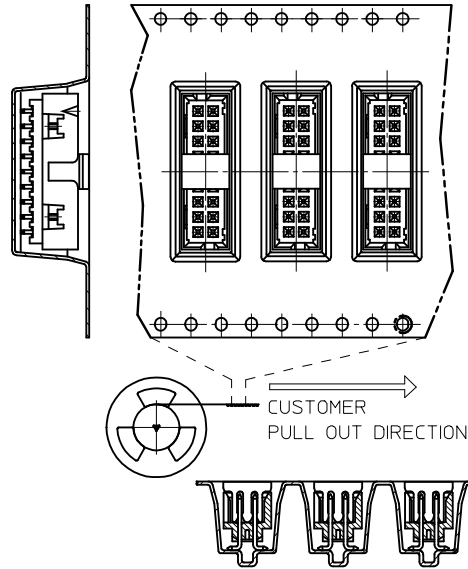

OPTION 2

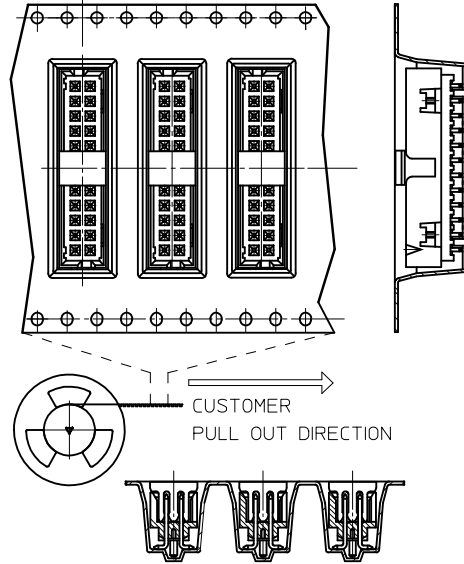

OPTION 3

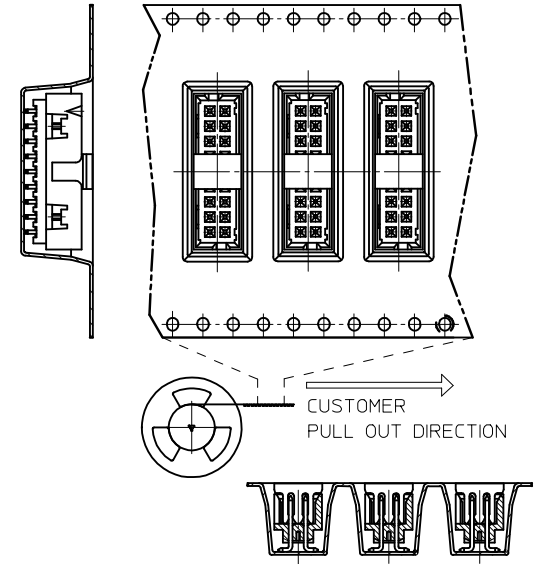

OPTION 4

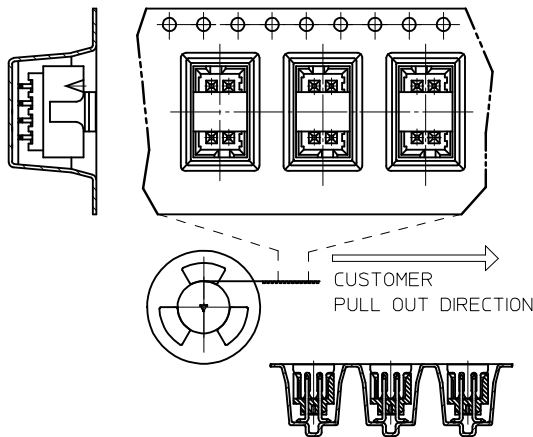

EMBOSSED TAPE & REEL POCKET DESCRIPTIONS

OPTIONS	CENTER POLARIZATION OPTIONS		PEG OPTIONS		PILOT HOLE OPTIONS	
	ON THE LEFT	ON THE RIGHT	WITH PEG	WITHOUT PEG	2 SIDES	1 SIDE
1	YES	N.A	YES	N.A	YES	N.A
2	N.A	YES	YES	N.A	YES	N.A
3	YES	N.A	N.A	YES	YES	N.A
4	YES	N.A	YES	N.A	N.A	YES

RELEASED EC NO: S2015-1435 DRWN:GMENARLY 2015/05/22 CHKD:CGOH 2015/09/21 APPR:KHL IM 2015/09/22	DESCRIPTION QUALITY SYMBOLS $F_A=0$ $F_B=0$ $F_C=0$	GENERAL TOLERANCES (UNLESS SPECIFIED)		DIMENSION STYLE MM ONLY		SCALE NTS	DESIGN UNITS METRIC	THIRD ANGLE PROJECTION			
			mm	INCH	DRAWN BY GMENARLY	DATE 2015/05/22	TITLE MILLIGRID 2MM PITCH, SMT VERTICAL SHROUDED HEADER				
			4 PLACES	± ---	± ---	CHECKED BY CGOH	DATE 2015/09/21	molex DOCUMENT NO. SD-87832-0001 SHEET NO. 12 OF 12			
			3 PLACES	± ---	± ---	APPROVED BY KHL IM	DATE 2015/09/22				
	2 PLACES	± 0.20	± ---	MATERIAL NO.		SEE TABLE					
	1 PLACE	± ---	± ---	ANGULAR ± 3 °		THIS DRAWING CONTAINS INFORMATION THAT IS PROPRIETARY TO MOLEX INCORPORATED AND SHOULD NOT BE USED WITHOUT WRITTEN PERMISSION					
	0 PLACE	± ---	± ---	DRAFT WHERE APPLICABLE MUST REMAIN WITHIN DIMENSIONS							