

776363-1 ✓ ACTIVE

AMP | AMPSEAL 16

TE Internal #: 776363-1

Automotive Seals & Cavity Plugs, Cavity Blanking Plug, PBT, Yellow,
-40 – 125 °C [-40 – 257 °F], AMPSEAL 16

[View on TE.com >](#)



Connectors > Automotive Connectors > Seals & Cavity Plugs > AMPSEAL 16 SEALING PLUGS



Connector Seal Type: **Cavity Blanking Plug**

Seal Material: **PBT**

Operating Temperature (Max): **65 °C, 70 °C, 75 °C, 80 °C, 85 °C, 90 °C, 100 °C, 105 °C, 110 °C, 120 °C, 125 °C [149 °F, 158 °F, 167 °F, 176 °F, 185 °F, 194 °F, 212 °F, 221 °F, 230 °F, 248 °F, 257 °F]**

Primary Product Color: **Yellow**

Operating Temperature Range: **-40 – 125 °C [-40 – 257 °F]**

[All AMPSEAL 16 SEALING PLUGS \(3\)](#)

Features

Product Type Features

Connector Seal Type	Cavity Blanking Plug
---------------------	----------------------

Body Features

Seal Material	PBT
Primary Product Color	Yellow

Usage Conditions

Operating Temperature (Max)	65 °C, 70 °C, 75 °C, 80 °C, 85 °C, 90 °C, 100 °C, 105 °C, 110 °C, 120 °C, 125 °C[149 °F][158 °F][167 °F][176 °F][185 °F][194 °F][212 °F][221 °F][230 °F][248 °F][257 °F]
Operating Temperature Range	-40 – 125 °C[-40 – 257 °F]

Industry Standards

UL Flammability Rating	UL 94HB
------------------------	---------

Packaging Features

Packaging Quantity	2500
Packaging Method	Package

Product Compliance

[For compliance documentation, visit the product page on TE.com>](#)

EU RoHS Directive 2011/65/EU	Compliant
EU ELV Directive 2000/53/EC	Compliant
China RoHS 2 Directive MIIT Order No 32, 2016	No Restricted Materials Above Threshold
EU REACH Regulation (EC) No. 1907/2006	Current ECHA Candidate List: JUNE 2022 (224) Candidate List Declared Against: JAN 2022 (223) SVHC > Threshold: Not Yet Reviewed
Halogen Content	Low Halogen - Br, Cl, F, I < 900 ppm per homogenous material. Also BFR/CFR/PVC Free
Solder Process Capability	Not applicable for solder process capability

Product Compliance Disclaimer

This information is provided based on reasonable inquiry of our suppliers and represents our current actual knowledge based on the information they provided. This information is subject to change. The part numbers that TE has identified as EU RoHS compliant have a maximum concentration of 0.1% by weight in homogenous materials for lead, hexavalent chromium, mercury, PBB, PBDE, DBP, BBP, DEHP, DIBP, and 0.01% for cadmium, or qualify for an exemption to these limits as defined in the Annexes of Directive 2011/65/EU (RoHS2). Finished electrical and electronic equipment products will be CE marked as required by Directive 2011/65/EU. Components may not be CE marked. Additionally, the part numbers that TE has identified as EU ELV compliant have a maximum concentration of 0.1% by weight in homogenous materials for lead, hexavalent chromium, and mercury, and 0.01% for cadmium, or qualify for an exemption to these limits as defined in the Annexes of Directive 2000/53/EC (ELV). Regarding the REACH Regulation, the information TE provides on SVHC in articles for this part number is based on the latest European Chemicals Agency (ECHA) 'Guidance on requirements for substances in articles' posted at this URL: <https://echa.europa.eu/guidance-documents/guidance-on-reach>

Compatible Parts

 <p>TE Part # CAT-AM7801-CH8172 AMPSEAL 16 HOUSINGS</p>	 <p>TE Part # CAT-D487-CH8172 DEUTSCH DT Series Housings & Connectors</p>	 <p>TE Part # CAT-H991-CH8172 AMPSEAL 16 HYBRID LEVER HOUSINGS</p>	 <p>TE Part # 2320913-1 2POS, AMPSEAL 16, PIN HSG ASSY, SLD, COD 1</p>
--	--	---	---



TE Part # 2320913-2
2POS,AMPSEAL 16,PIN HSG ASSY,
SLD,COD 2



TE Part # 2320913-3
2POS,AMPSEAL 16,PIN HSG ASSY,
SLD,COD 3



TE Part # 2320913-4
2POS,AMPSEAL 16,PIN HSG ASSY,
SLD,COD 4



TE Part # 2320926-1
2POS,AMPSEAL 16,PIN HSG ASSY,
SLD,COD 1



TE Part # 2320926-2
2POS,AMPSEAL 16,PIN HSG ASSY,
SLD,COD 2



TE Part # 2320926-3
2POS,AMPSEAL 16,PIN HSG ASSY,
SLD,COD 3



TE Part # 2320926-4
2POS,AMPSEAL 16,PIN HSG ASSY,
SLD,COD 4



TE Part # 2338211-1
CAP PIN ASSY, 4P, W2W, SEALED
COAX



TE Part # 2338212-1
PLUG SOCKET ASSY, 4P, W2W,
SEALED COAX



TE Part # 2325349-2
Power Versa-Lock REAR SEAL, 1X2,
LargeID



TE Part # 2325349-3
Power Versa-Lock REAR SEAL, 1X3,
LargeID



TE Part # 2325349-4
POWER VERSA-LOCK REAR SEAL,
1X4, LargeID

TE Part # 2338211-2
CAP PIN ASSY, 4P, W2W, SEALED
COAX

TE Part # 2338211-3
CAP PIN ASSY, 4P, W2W, SEALED
COAX

TE Part # 2338211-4
CAP PIN ASSY, 4P, W2W, SEALED
COAX

TE Part # 2338212-2
PLUG SOCKET ASSY, 4P, W2W,
SEALED COAX

Also in the Series | AMPSEAL 16



Automotive Connector Caps & Covers
(85)



Automotive Connector Locks &
Position Assurance(2)



Automotive Housings(241)



Automotive Seals & Cavity Plugs(4)

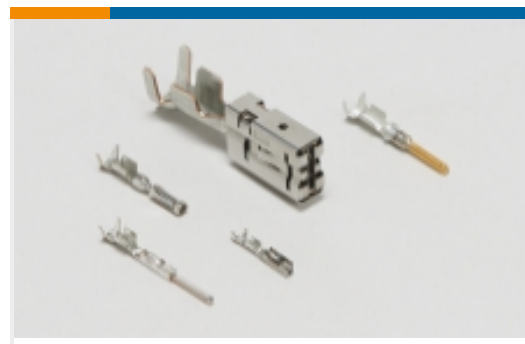

Automotive Terminals(33)



Data Connectivity Housings(3)



Other Automotive Connector Accessories(11)

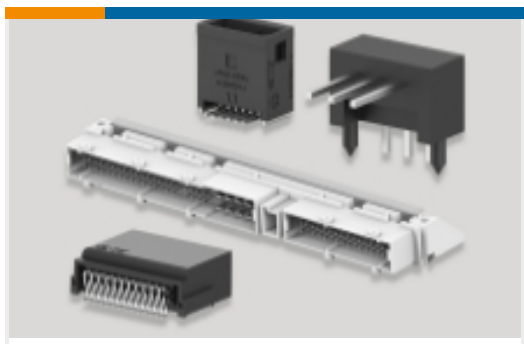

PCB Headers & Receptacles(3)

Customers Also Bought

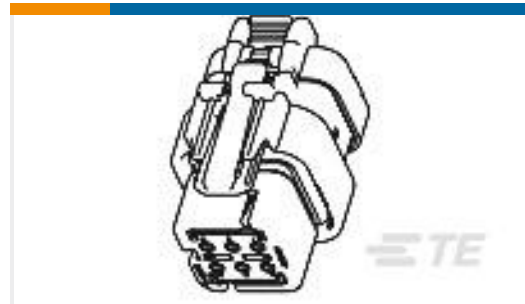

TE Part #776531-1
AS 16, 6P PLUG ASSY, RD, KEY 1

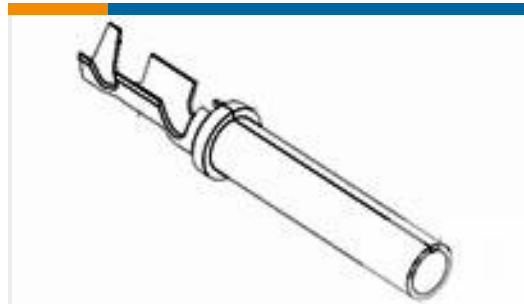

TE Part #1924464-1
SOC, SF, SIZE 16, 18-20 AWG, AU/SN



TE Part #881606-2
FF 375 RECEPTACLE 4.0-6.0 MM2 1.01 TPBR



TE Part #880684-2
.140 DIA PIN

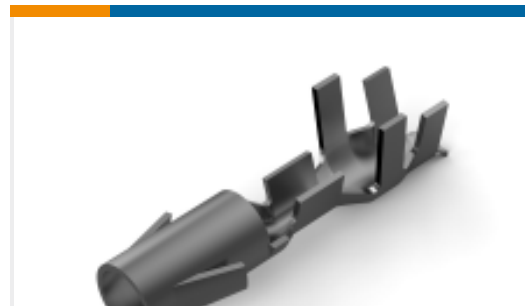

TE Part #880686-2
.140 DIA SOCKET



TE Part #1480838-1
MAXI RELAY SUPORT



TE Part #881572-4
FUSE CONTACT BUS BA



TE Part #E296612001
DSPL-NR1-X-STK

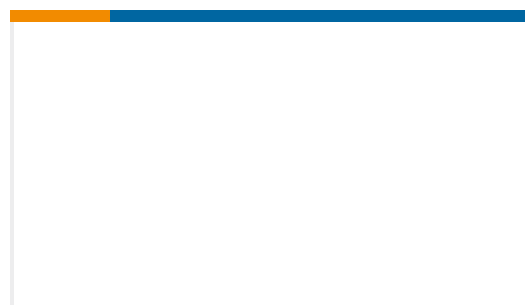

TE Part #ZPF00000000000015872
DTP 07-20-41 K

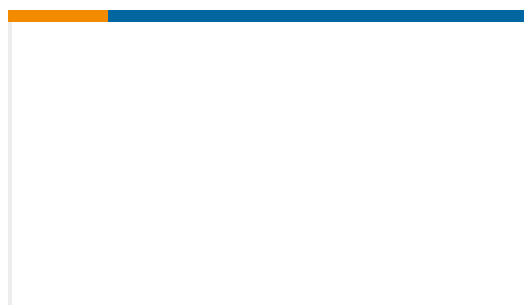

TE Part #1599962-2
MAXI FUSE BOX WITH JCASE ASSY

Documents

Product Drawings

[SEALING PLUG, SZ 16 CAVITY](#)

English

CAD Files

[Customer View Model](#)

[ENG_CVM_776363-1_O.3d_igs.zip](#)

English

[Customer View Model](#)



[ENG_CVM_776363-1_O.3d_stp.zip](#)

English

Customer View Model

[ENG_CVM_776363-1_O.2d_dxf.zip](#)

English

3D PDF

English

By downloading the CAD file I accept and agree to the [Terms and Conditions](#) of use.

Datasheets & Catalog Pages

ICT Terminals and Connectors Catalogue

English

CONNECTOR SELECTOR

English

Product Specifications

Application Specification

English

Application Specification

English

Size 16 Socket Contact Assembly

English

Application Specification

English

Product Environmental Compliance

MD_776363-1_02022018446_dmtec

English

MD_776363-1_02022018446_dmtec

English

Instruction Sheets

Instruction Sheet (U.S.)

English