

770232-1 ✓ ACTIVE

MATE-N-LOK | Commercial MATE-N-LOK

TE Internal #: 770232-1

Rectangular Caps & Covers, Dust Cover, -55 – 105 °C [-67 – 185 °F],

UL 94V-0, Commercial MATE-N-LOK

[View on TE.com >](#)



Connectors > Rectangular Connectors > Rectangular Connector Accessories > Rectangular Caps & Covers



Protection & Strain Relief Accessory Type: **Dust Cover**

Operating Temperature Range: **-55 – 105 °C [-67 – 185 °F]**

UL Flammability Rating: **UL 94V-0**

Features

Product Type Features

Product Type	Accessory
Protection & Strain Relief Accessory Type	Dust Cover

Body Features

Color	White
Material	Polyester

Usage Conditions

Operating Temperature Range	-55 – 105 °C[-67 – 185 °F]
-----------------------------	----------------------------

Industry Standards

UL Flammability Rating	UL 94V-0
------------------------	----------

Packaging Features

Packaging Method	Box
Packaging Quantity	5

Other

Comment	For standard wiring. For use with Insulation Displacement Connectors only.
---------	--

Product Compliance



For compliance documentation, visit the product page on [TE.com](#)>

EU RoHS Directive 2011/65/EU	Compliant
EU ELV Directive 2000/53/EC	Compliant
China RoHS 2 Directive MIIT Order No 32, 2016	No Restricted Materials Above Threshold
EU REACH Regulation (EC) No. 1907/2006	Current ECHA Candidate List: JUNE 2022 (224) Candidate List Declared Against: JAN 2022 (223) SVHC > Threshold: Not Yet Reviewed
Halogen Content	Not Low Halogen - contains Br or Cl > 900 ppm.
Solder Process Capability	Not applicable for solder process capability

Product Compliance Disclaimer

This information is provided based on reasonable inquiry of our suppliers and represents our current actual knowledge based on the information they provided. This information is subject to change. The part numbers that TE has identified as EU RoHS compliant have a maximum concentration of 0.1% by weight in homogenous materials for lead, hexavalent chromium, mercury, PBB, PBDE, DBP, BBP, DEHP, DIBP, and 0.01% for cadmium, or qualify for an exemption to these limits as defined in the Annexes of Directive 2011/65/EU (RoHS2). Finished electrical and electronic equipment products will be CE marked as required by Directive 2011/65/EU. Components may not be CE marked. Additionally, the part numbers that TE has identified as EU ELV compliant have a maximum concentration of 0.1% by weight in homogenous materials for lead, hexavalent chromium, and mercury, and 0.01% for cadmium, or qualify for an exemption to these limits as defined in the Annexes of Directive 2000/53/EC (ELV). Regarding the REACH Regulation, the information TE provides on SVHC in articles for this part number is based on the latest European Chemicals Agency (ECHA) 'Guidance on requirements for substances in articles' posted at this URL: <https://echa.europa.eu/guidance-documents/guidance-on-reach>

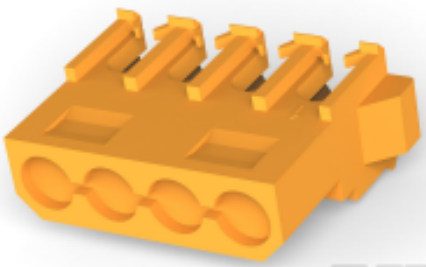
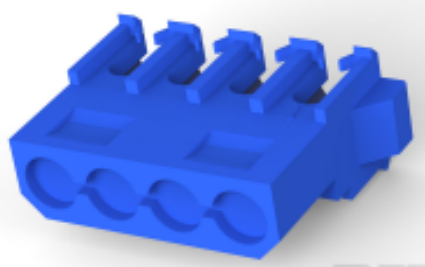
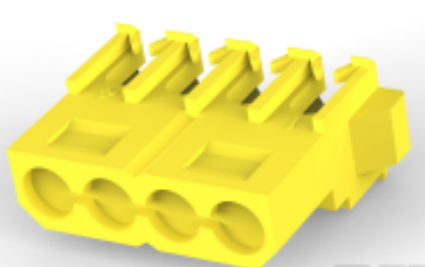
Compatible Parts

 <p>TE Part # 794036-1 4P CMNL IDC PLUG 18AWG ORG V0</p>	 <p>TE Part # 794036-4 4P CMNL IDC PLUG 16AWG BLU V0</p>	 <p>TE Part # 770156-4 4P CMNL IDC PLUG 20AWG YEL V2</p>	 <p>TE Part # 770233-1 CMNL IDC COVER</p>
---	---	---	--



Also in the Series | Commercial MATE-N-LOK

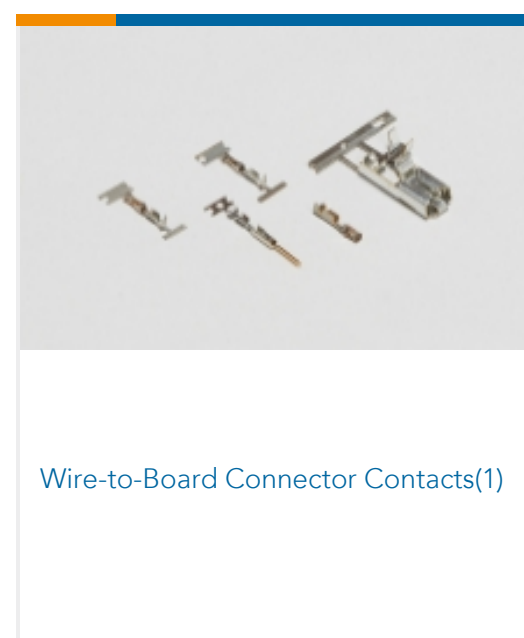
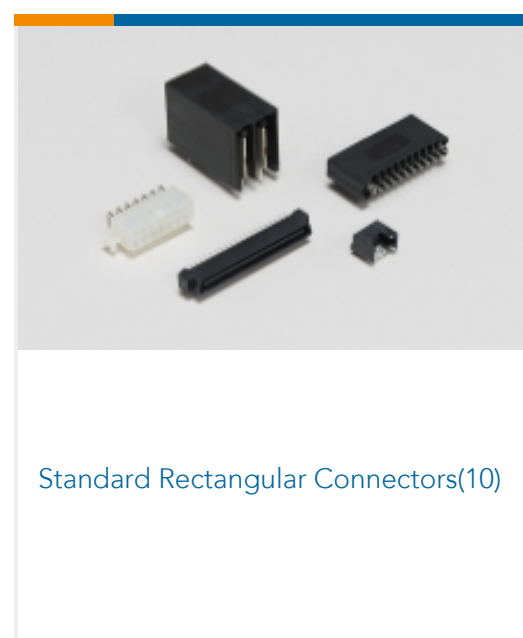
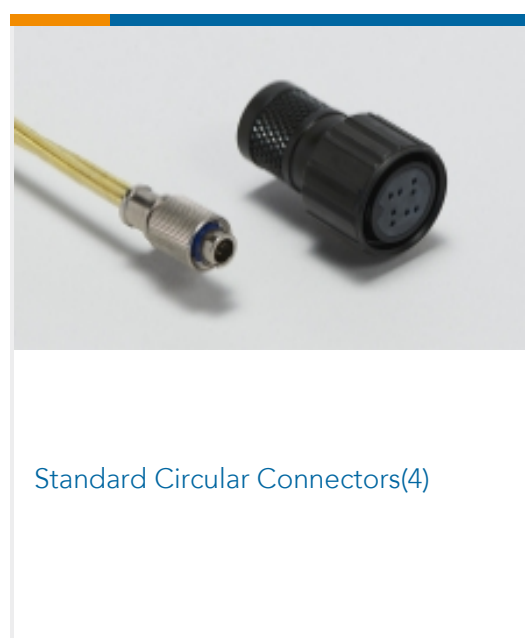
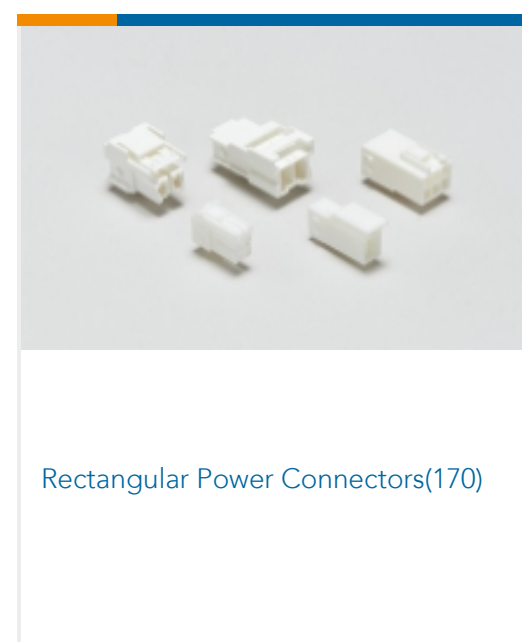
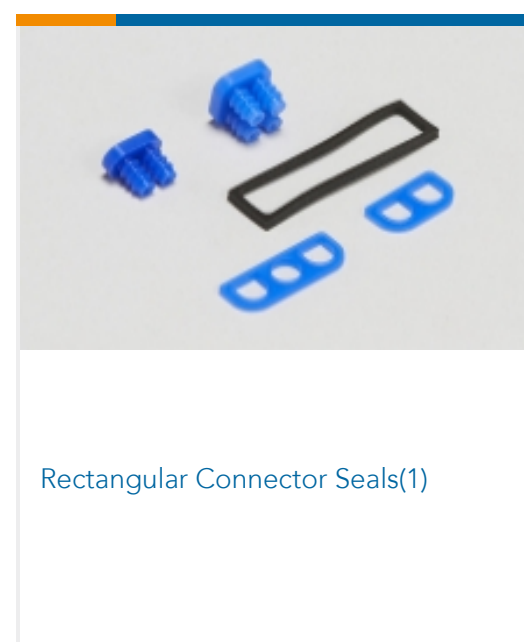
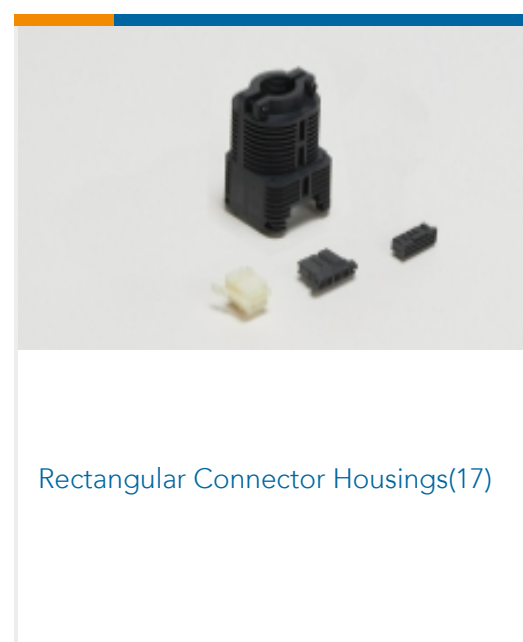
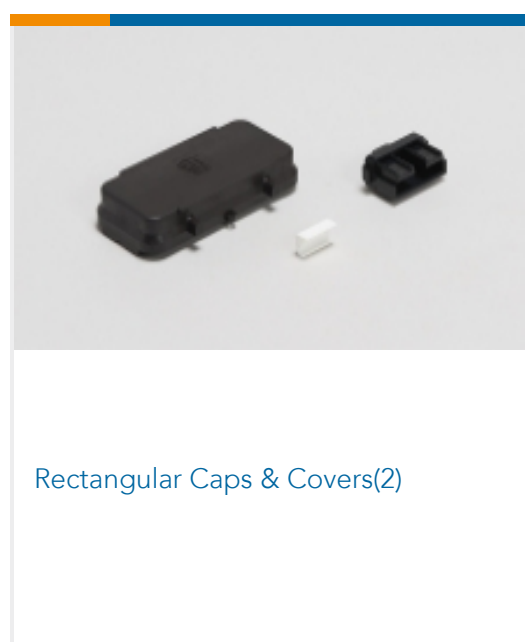
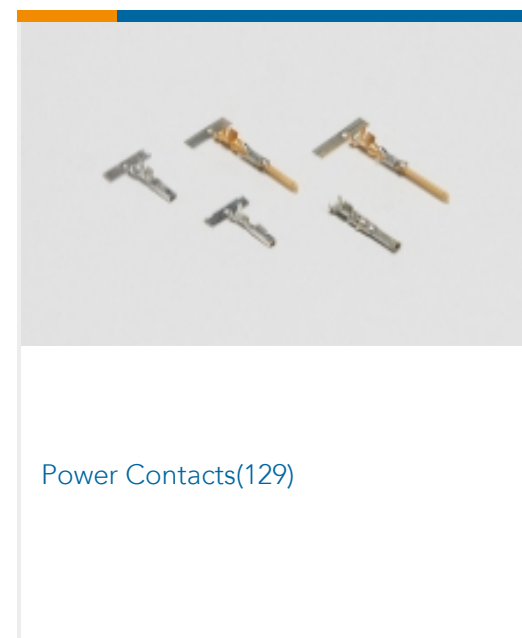
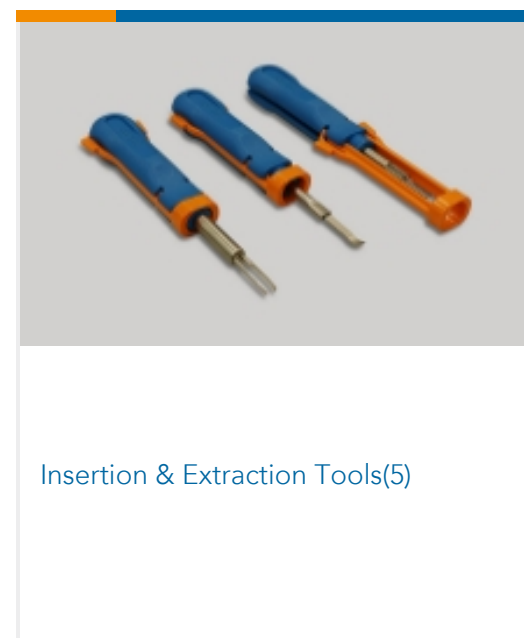
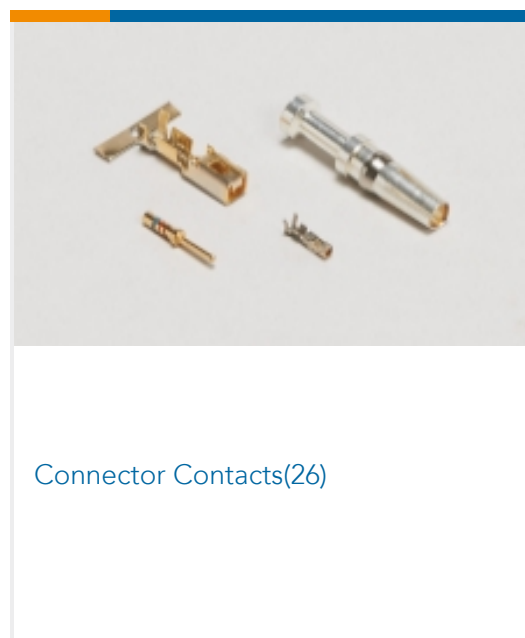

Customers Also Bought

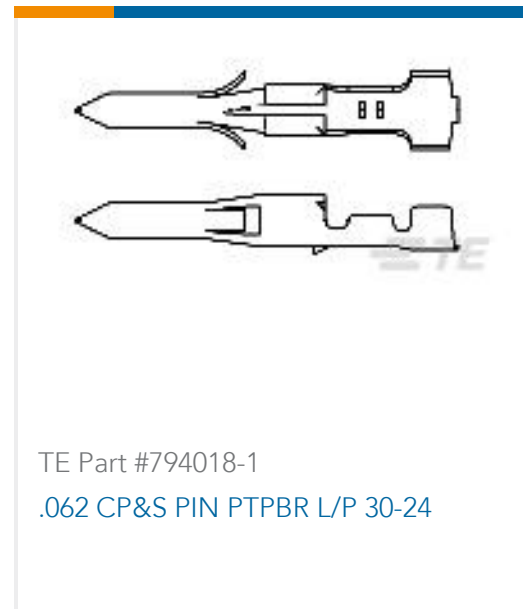
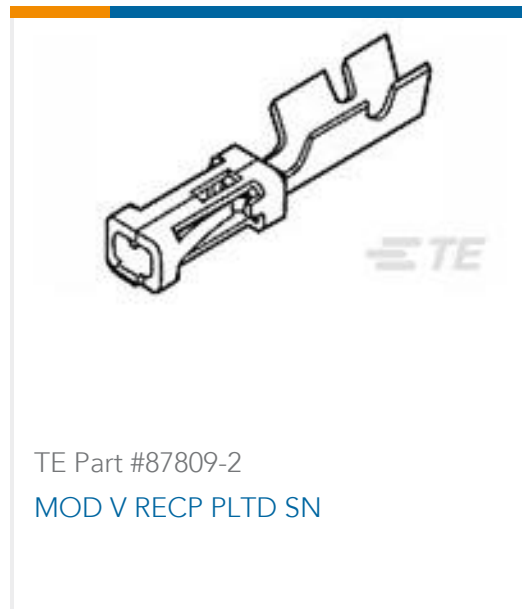

Documents

CAD Files

3D PDF

3D

Customer View Model

[ENG_CVM_CVM_770232-1_C.2d_dxf.zip](#)

English

Customer View Model

[ENG_CVM_CVM_770232-1_C.3d_igs.zip](#)

English

Customer View Model

[ENG_CVM_CVM_770232-1_C.3d_stp.zip](#)

English

3D PDF

English

Customer View Model

[ENG_CVM_770232-1_B.2d_dxf.zip](#)

English

Customer View Model



[ENG_CVM_770232-1_B.3d_igs.zip](#)

English

Customer View Model

[ENG_CVM_770232-1_B.3d_stp.zip](#)

English

By downloading the CAD file I accept and agree to the [Terms and Conditions](#) of use.

Datasheets & Catalog Pages

[SOFT_SHELL_PIN_SOCKET_CONNECTORS_STANDARD_DENSITY](#)

English

Product Specifications

Application Specification

Japanese

[MATE-N-LOK Commercial IDC \(Insulation Displacement Connectors\)](#)

Japanese

Application Specification

English

[MATE-N-LOK Commercial IDC \(Insulation Displacement Connectors\)](#)

English

Product Environmental Compliance

[MD_770232-1_08082018542_dmtec](#)

English

[MD_770232-1_08082018542_dmtec](#)

English