

TK タイプコネクタとは、Mターミナルタブ幅 1.0mm の小型コネクタです。  
TK TYPE CONNECTOR: MINUATURIZED CONNECTOR AND THE BLADE WIDTH OF THE MALE TERMINAL FOR THIS CONNECTOR IS 0.040 INCHES.

### [特 徴] (DISTINCTIVE FEATURES)

- ① 慣性ロック方式により、コネクタの中途かん合をなくします。
  - ② ハウジングへのリヤホルダタブリセット化により、作業性を向上させました。
  - ③ 後方より押し込む二重係止機構により、端子抜けを確実に防止できます。
1. STABLE/SECURE MATING ACTION BETWEEN MALE AND FEMALE CONNECTOR.
  2. PRE-SET REAR HOLDER IMPROVE WORKABILITY.
  3. DOUBLE LOCKING MECHANISM TO PREVENT TERMINAL PUSH-OUT.

### 構造と名称 CONSTRUCTION

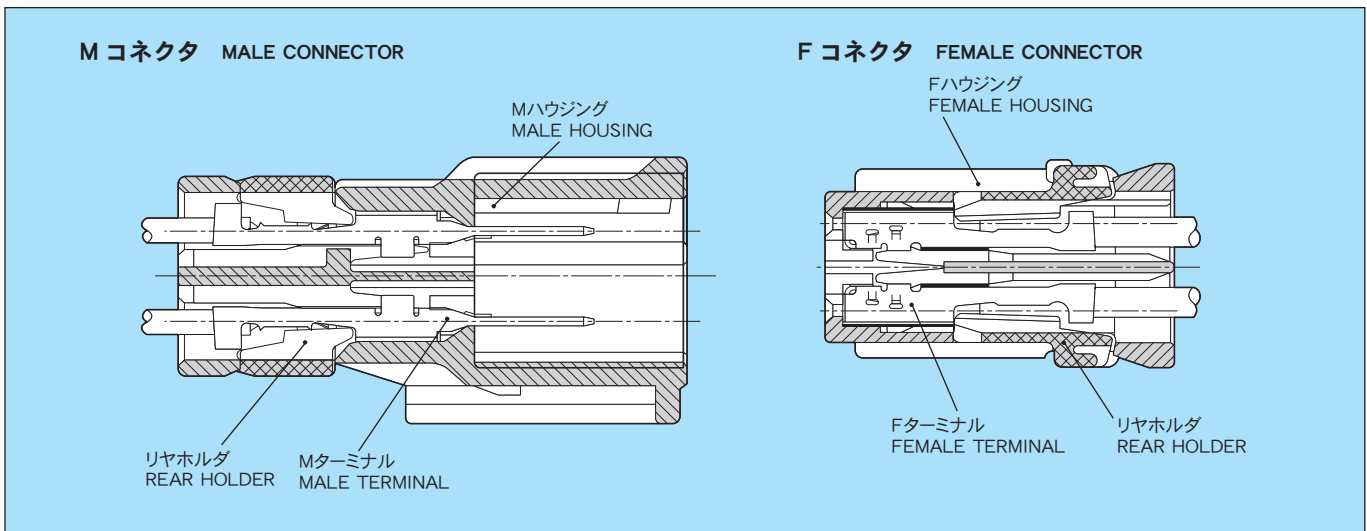

### 仕様 SPECIFICATIONS

|  |                           |   |
|--|---------------------------|---|
| 材<br>質                                       | ハウジング<br>HOUSING          | PBT   |
|  | Mターミナル<br>MALE TERMINAL   | 黄銅 (Sn メッキ), 黄銅 (Au メッキ)<br>BRASS(TIN PLATING), BRASS(GOLD PLATING)                 |
|  | Fターミナル<br>FEMALE TERMINAL | 銅合金 (Sn メッキ), 銅合金 (Au メッキ)<br>COPPER ALLOY(TIN PLATING), COPPER ALLOY(GOLD PLATING) |
| ※許容電流 (参考値)<br>※CURRENT CAPACITY (REFERENCE) |                           | 3A(24P)   |
| 低電圧低電流抵抗<br>RESISTANCE AT LOW VOLTAGE        |                           | 10mΩ 以下 (初期値)<br>10mΩ MAX. (INITIAL VALUE)  |
| 絶縁抵抗<br>INSULATION RESISTANCE                |                           | DC500V 100MΩ 以上<br>DC500V 100MΩ MIN.  |
| 耐電圧<br>DIELECTRIC STRENGTH                   |                           | AC500V (1 分間)<br>AC500V (1 min.)  |

※許容電流：使用極数・電線サイズ・通電時間及び使用温度により数値は異なります。

※ CURRENT CAPACITY WILL BE AFFECTED BY CONDITIONS SUCH AS POLE QUANTITY, WIRE SIZE, AMBIENT TEMPERATURE, ETC.

### 部品品番一覧 PART NUMBER CHART

| 部品名称<br>PART NAME | M                            | F                            |
|-------------------|------------------------------|------------------------------|
| ターミナル<br>TERMINAL | 7114-4239-02<br>7114-4239-08 | 7116-4233-02<br>7116-4233-08 |

| 部品名称<br>PART NAME                | 極数<br>POLES | M                        | F                        |
|----------------------------------|-------------|--------------------------|--------------------------|
| ハウジング<br>HOUSING                 | 1           |                          | 7283-5970                |
|                                  | 2           | 7282-5971-30             | 7283-5971-30             |
|                                  | 2           | 7282-5971-80             | 7283-5971-80             |
|                                  | 2           | 7282-5972                | 7283-5972                |
|                                  | 2           | 7282-5973-40             | 7283-5973-40             |
|                                  | 3           | 7282-5974                | 7283-5974                |
|                                  | 4           | 7282-5976                | 7283-5976                |
|                                  | 4           |                          | 7283-5977-40             |
|                                  | 6           | 7282-5978-40             | 7283-5978-40             |
|                                  | 6           | 7282-5982                | 7283-5982                |
|                                  | 8           | 7282-5980-40             | 7283-5980-40             |
|                                  | 8           | 7282-5985                | 7283-5985                |
|                                  | 8           |                          | 7283-5986-80             |
|                                  | 10          | 7282-6360                | 7283-6360                |
|                                  | 12          | 7282-5988                | 7283-5988                |
| 完全かん合タイプ<br>COMPLETE MATING TYPE | 6           | 7282-4065-60             | 7283-4065-60             |
|                                  | 12          | 7282-4066-60             | 7283-4066-60             |
|                                  | 12          | 7282-4066-70 (7134-4468) | 7283-4066-70 (7134-4469) |

( ) はカバー品番 COVER PART NUMBER IN PARENTHESIS.

### ターミナル TERMINAL

単位 : mm UNIT: mm

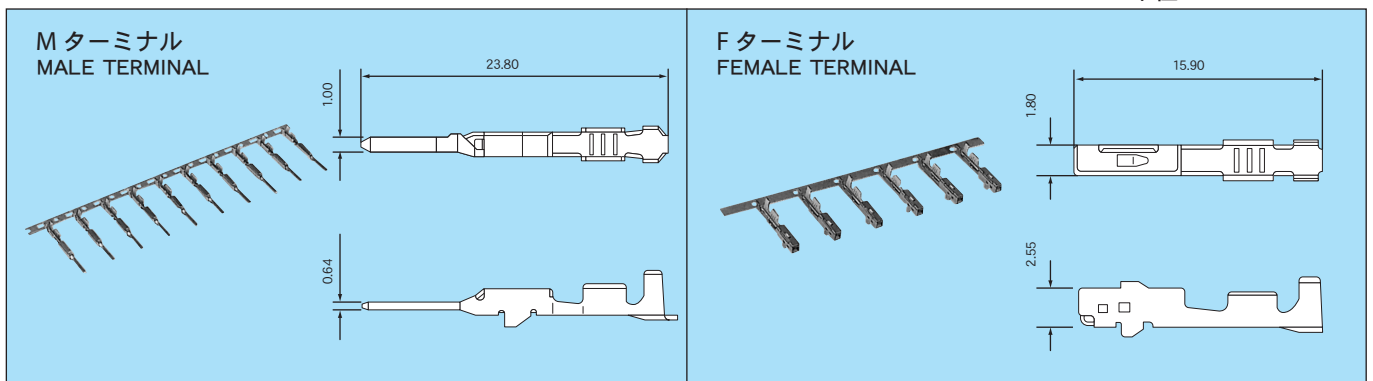

### 仕様 SPECIFICATIONS

| 部品名称<br>PART NAME          | 品番<br>PART NUMBER | 材質<br>MATERIAL      | 表面処理<br>TREATMENT      | 板厚 (mm)<br>MATERIAL THICKNESS |
|----------------------------|-------------------|---------------------|------------------------|-------------------------------|
| M ターミナル<br>MALE TERMINAL   | 7114-4239-02      | 黄銅<br>BRASS         | Sn メッキ<br>TIN PLATING  | 0.3                           |
|                            | 7114-4239-08      |                     | Au メッキ<br>GOLD PLATING |                               |
| F ターミナル<br>FEMALE TERMINAL | 7116-4233-02      | 銅合金<br>COPPER ALLOY | Sn メッキ<br>TIN PLATING  | 0.25                          |
|                            | 7116-4233-08      |                     | Au メッキ<br>GOLD PLATING |                               |

### 適用電線一覧 APPLICABLE WIRE CHART

| 部品名称<br>PART NAME          | 適用電線サイズ (mm)<br>WIRE SIZE (mm <sup>2</sup> ) | 電線品種<br>WIRE TYPE | 品番<br>PART NUMBER (TERMINAL) |
|----------------------------|--|-------------------|------------------------------|
| M ターミナル<br>MALE TERMINAL   | 0.3  | CAVS              | 7114-4239-02                 |
|                            |  |                   | 7114-4239-08                 |
|                            | 0.5  | CAVS              | 7114-4239-02                 |
|                            |  |                   | 7114-4239-08                 |
| F ターミナル<br>FEMALE TERMINAL | 0.3  | CAVS              | 7116-4233-02                 |
|                            |  |                   | 7116-4233-08                 |
|                            | 0.5  | CAVS              | 7116-4233-02                 |
|                            |  |                   | 7116-4233-08                 |

※ターミナルは TE Connectivity の製品です。 ※TERMINAL IS THE PRODUCT OF TE CONNECTIVITY.

ハウジング 材質 : PBT HOUSING MATERIAL: PBT

単位 : mm UNIT: mm

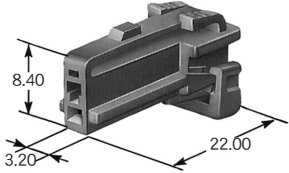
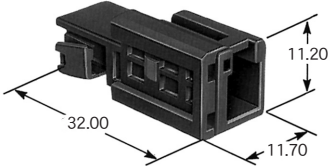
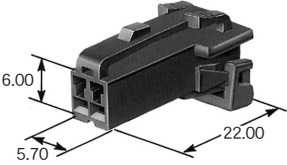
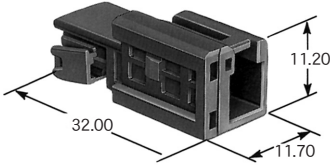
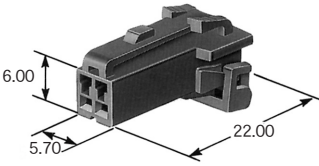
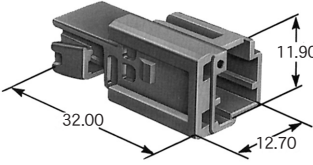
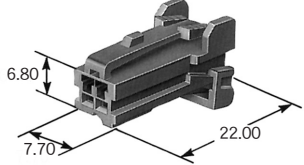
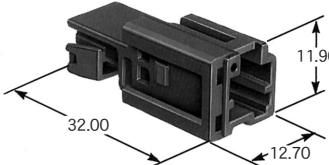
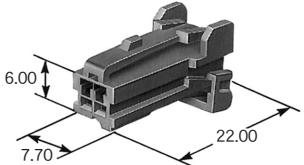
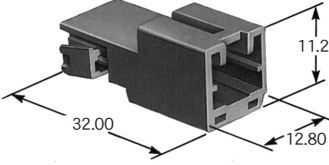
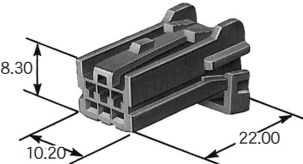
| 極数<br>POLES | M ハウジング<br>MALE HOUSING  | F ハウジング<br>FEMALE HOUSING  |
|-------------|--|--|
| 1           |   |  <p>TK01FW</p> <p>7283-5970</p>       |
| 2           |  <p>TK02MBR-P-B</p> <p>7282-5971-30</p> |  <p>TK02FBR-B</p> <p>7283-5971-30</p> |
| 2           |  <p>TK02MBR-P</p> <p>7282-5971-80</p>  |  <p>TK02FBR</p> <p>7283-5971-80</p>  |
| 2           |  <p>TK02MW</p> <p>7282-5972</p>       |  <p>TK02FW</p> <p>7283-5972</p>     |
| 2           |  <p>TK02MGY</p> <p>7282-5973-40</p>   |  <p>TK02FGY</p> <p>7283-5973-40</p> |
| 3           |  <p>TK03MW</p> <p>7282-5974</p>       |  <p>TK03FW</p> <p>7283-5974</p>     |

ハウジング 材質 : PBT HOUSING MATERIAL: PBT

単位 : mm UNIT: mm

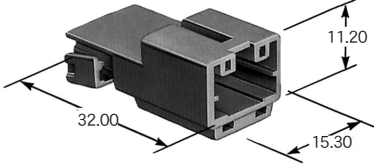
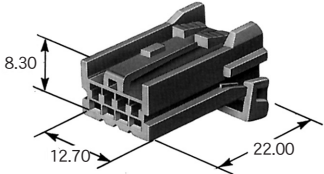
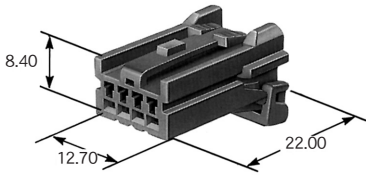
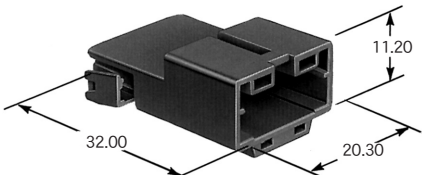
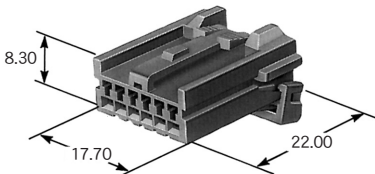
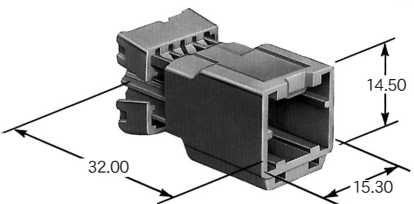
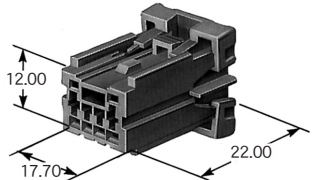
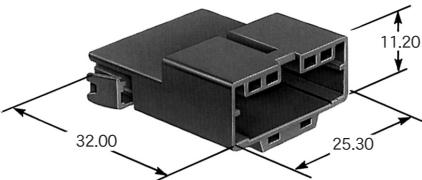
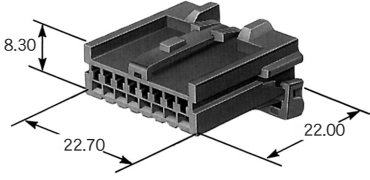
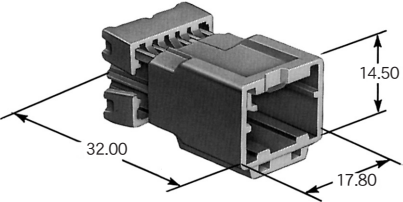
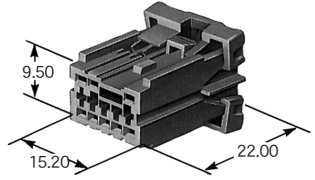
| 極数<br>POLES | M ハウジング<br>MALE HOUSING   | F ハウジング<br>FEMALE HOUSING   |
|-------------|---|---|
| 4           | <p style="text-align: right;">TK04MW</p>  <p style="text-align: center;">7282-5976</p>       | <p style="text-align: right;">TK04FW</p>  <p style="text-align: center;">7283-5976</p>       |
| 4           | <p style="text-align: center;">—————</p>  | <p style="text-align: right;">TK04FGY</p>  <p style="text-align: center;">7283-5977-40</p>   |
| 6           | <p style="text-align: right;">TK06MGY</p>  <p style="text-align: center;">7282-5978-40</p>  | <p style="text-align: right;">TK06FGY</p>  <p style="text-align: center;">7283-5978-40</p>   |
| 6           | <p style="text-align: right;">TK06MW-IV</p>  <p style="text-align: center;">7282-5982</p>  | <p style="text-align: right;">TK06FW-IV</p>  <p style="text-align: center;">7283-5982</p>  |
| 8           | <p style="text-align: right;">TK08MGY</p>  <p style="text-align: center;">7282-5980-40</p> | <p style="text-align: right;">TK08FGY</p>  <p style="text-align: center;">7283-5980-40</p> |
| 8           | <p style="text-align: right;">TK08MW</p>  <p style="text-align: center;">7282-5985</p>     | <p style="text-align: right;">TK08FW</p>  <p style="text-align: center;">7283-5985</p>     |

ハウジング 材質 : PBT HOUSING MATERIAL: PBT

単位 : mm UNIT: mm

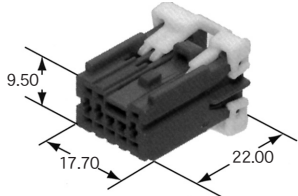
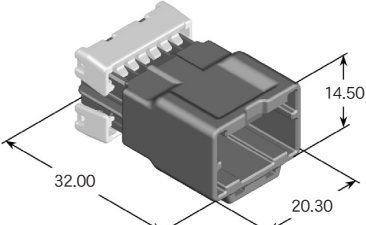
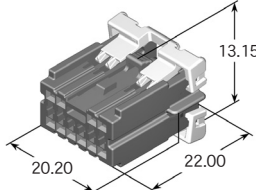
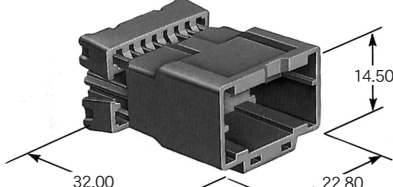
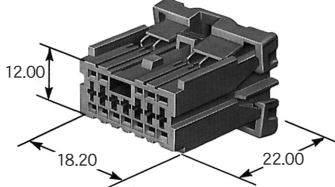
| 極数<br>POLES | M ハウジング<br>MALE HOUSING   | F ハウジング<br>FEMALE HOUSING   |
|-------------|---|---|
| 8           |                                  |  <p>TK08FBR</p> <p>7283-5986-80</p> |
| 10          |  <p>TK10MW</p> <p>7282-6360</p>  |  <p>TK10FW</p> <p>7283-6360</p>    |
| 12          |  <p>TK12MW</p> <p>7282-5988</p> |  <p>TK12FW</p> <p>7283-5988</p>    |

ハウジング 完全かん合タイプ 材質：PBT HOUSING COMPLETE MATING TYPE MATERIAL: PBT

単位：mm UNIT:mm

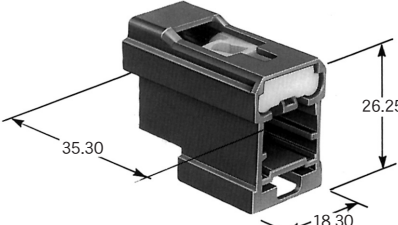
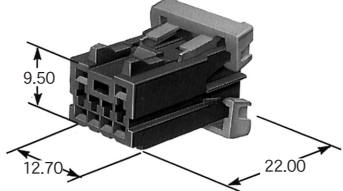
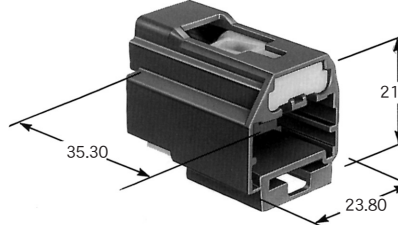
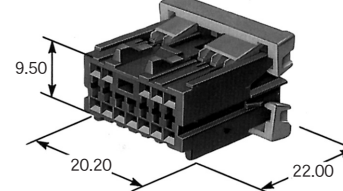
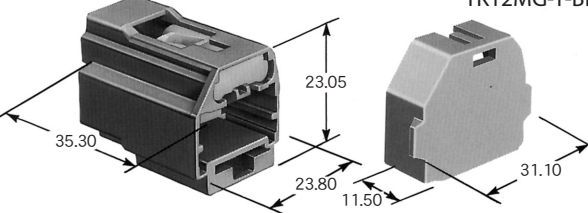
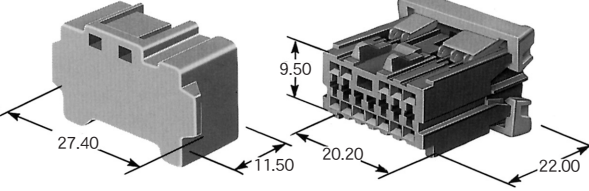
| 極数<br>POLES | M ハウジング<br>MALE HOUSING   | F ハウジング<br>FEMALE HOUSING   |
|-------------|---|---|
| 6           | <p>TK06MG-BD</p>  <p>7282-4065-60</p>                | <p>TK06FG</p>  <p>7283-4065-60</p>               |
| 12          | <p>TK12MG-BD</p>  <p>7282-4066-60</p>                | <p>TK12FG</p>  <p>7283-4066-60</p>               |
| 12          | <p>TK12MG-Y-BD</p>  <p>7282-4066-70 (7134-4468)</p> | <p>TK12FG-Y</p>  <p>(7134-4469) 7283-4066-70</p> |

( ) はカバー品番 COVER PART NUMBER IN PARENTHESIS.