

Vタイプコネクタとは、Mターミナルタブ幅 1.2mm の小型防水コネクタです。

V TYPE CONNECTOR: THE BLADE WIDTH OF THE MALE TERMINAL FOR THIS CONNECTOR IS 0.050 INCHES. MINIATURIZED SEALED CONNECTOR.

[特 徴] (DISTINCTIVE FEATURES)

① Fターミナルに耐久性に優れ信頼性の高いベリリウム銅を組込みました。

② リヤホルダにより防水栓の抜けを防止します。

1. BERYLLIUM COPPER, WHICH HAS DURABILITY AND IS RELIABLE, IS USED FOR THIS FEMALE TERMINAL.

2. REAR HOLDER SYSTEM ELIMINATES WIRE SEAL PUSH-OUT.

構造と名称 CONSTRUCTION

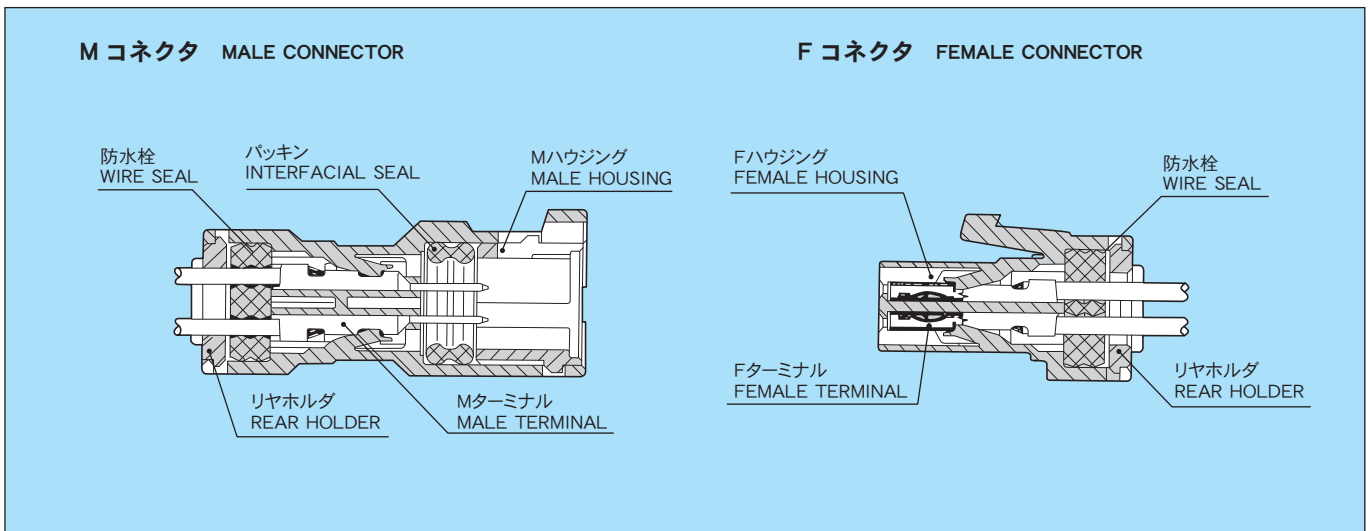

仕様 SPECIFICATIONS

材 質	ハウジング HOUSING	PBT
	Mターミナル MALE TERMINAL	黄銅 (Sn メッキ), 黄銅 (Au メッキ) BRASS(TIN PLATING), BRASS(GOLD PLATING)
	Fターミナル FEMALE TERMINAL	本体: 黄銅 (Sn メッキ), 黄銅 (Au メッキ) バネ部: 銅合金 (Sn メッキ), 銅合金 (Au メッキ) BODY: BRASS(TIN PLATING), BRASS(GOLD PLATING) SPRING: COPPER ALLOY(TIN PLATING), COPPER ALLOY(GOLD PLATING)
※許容電流 (参考値) ※CURRENT CAPACITY (REFERENCE)		3A
低電圧低電流抵抗 RESISTANCE AT LOW VOLTAGE		10mΩ 以下 (初期値) 10mΩ MAX. (INITIAL VALUE)
絶縁抵抗 INSULATION RESISTANCE		DC500V 250MΩ 以上 DC500V 250MΩ MIN.
耐電圧 DIELECTRIC STRENGTH		AC1000V (1 分間) AC1000V (1 min.)

※許容電流：使用極数・電線サイズ・通電時間及び使用温度により数値は異なります。

※ CURRENT CAPACITY WILL BE AFFECTED BY CONDITIONS SUCH AS POLE QUANTITY, WIRE SIZE, AMBIENT TEMPERATURE, ETC.

部品品番一覧 PART NUMBER CHART

部品名称 PART NAME	M	F
ターミナル TERMINAL	7114-1260 7114-1260-08	7116-1261 7116-1261-08
部品名称 PART NAME	M・F 共通 COMMON FOR MALE AND FEMALE	
防水栓 WIRE SEAL	ハウジング品番一覧参照 REFER TO PART NUMBER CHART OF HOUSING.	

部品名称 PART NAME	極数 POLES	M			F		
		ハウジング HOUSING	リヤホルダ REAR HOLDER	防水栓 WIRE SEAL	ハウジング HOUSING	リヤホルダ REAR HOLDER	防水栓 WIRE SEAL
ハウジング HOUSING	2	7222-1835	7157-3597-60	————	7123-1835	7157-3597-60	————
	3	7222-1835	7157-3596-30	————	7123-1835	7157-3596-30	————
	4	7222-1865-40	7157-6565-80	7157-3595-60	7123-1865-40	7157-6565-80	7157-3595-60
	5	7222-1865-40	7157-6565-80	7157-3594	7123-1865-40	7157-6565-80	7157-3594
	6	7222-1865-40	7157-6565-80	7157-3593-80	7123-1865-40	7157-6565-80	7157-3593-80

ターミナル TERMINAL

単位：mm UNIT:mm

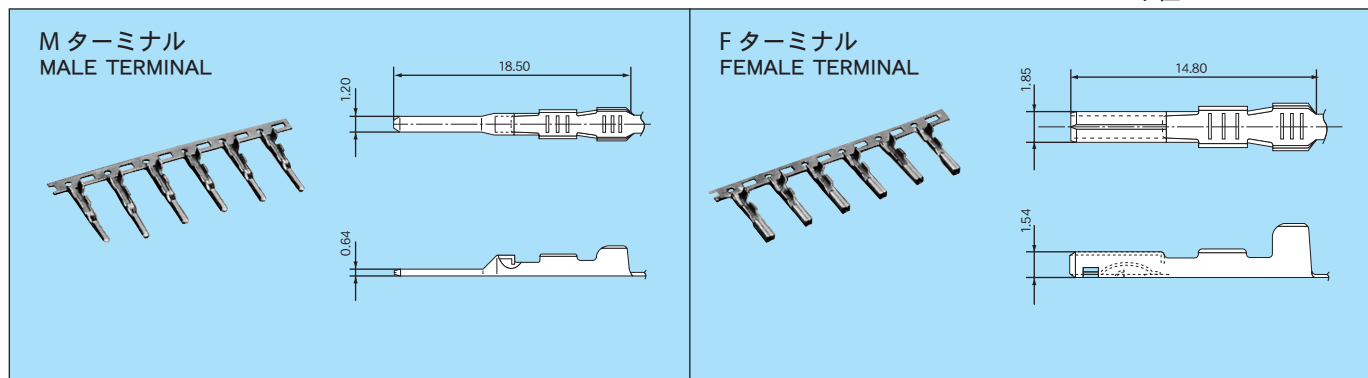

仕様 SPECIFICATIONS

部品名称 PART NAME	品番 PART NUMBER	材質 MATERIAL	表面処理 TREATMENT	板厚 (mm) MATERIAL THICKNESS
M ターミナル MALE TERMINAL	7114-1260	黄銅 BRASS	Sn メッキ TIN PLATING	0.25
	7114-1260-08		Au メッキ GOLD PLATING	
F ターミナル FEMALE TERMINAL	7116-1261	本体：黄銅 BODY: BRASS バネ部：銅合金 SPRING: COPPER ALLOY	Sn メッキ TIN PLATING	0.2
	7116-1261-08		Au メッキ GOLD PLATING	

リヤホルダ一体型防水栓 REAR HOLDER INTEGRATED WIRE SEAL

部品名称 PART NAME	品番 PART NUMBER	材質 MATERIAL	色相 COLOR	備考 NOTE
リヤホルダ一体型防水栓 REAR HOLDER INTEGRATED WIRE SEAL	7157-3597-60	NBR	茶 BROWN	
	7157-3596-30	NBR	黒 BLACK	

防水栓 WIRE SEAL

部品名称 PART NAME	品番 PART NUMBER	材質 MATERIAL	色相 COLOR	備考 NOTE
防水栓 WIRE SEAL	7157-3595-60	シリコンゴム SILICONE	緑 GREEN	
	7157-3594	シリコンゴム SILICONE	黒 BLACK	
	7157-3593-80	シリコンゴム SILICONE	茶 BROWN	

●適用電線一覧(ターミナル・防水栓) APPLICABLE WIRE CHART (TERMINAL, WIRE SEAL)

部品名称 PART NAME	適用電線サイズ (mm) WIRE SIZE (mm)	電線品種 WIRE TYPE	端子品番 PART NUMBER (TERMINAL)
M ターミナル MALE TERMINAL	0.3	AVS	7114-1260、7114-1260-08
	0.5	AVS	7114-1260、7114-1260-08
F ターミナル FEMALE TERMINAL	0.3	AVS	7116-1261、7116-1261-08
	0.5	AVS	7116-1261、7116-1261-08

※防水栓は、ハウジング極数専用

※ WIRE SEAL IS EXCLUSIVE PART FOR POLE QUANTITY OR EACH HOUSING

ハウジング 材質 : PBT HOUSING MATERIAL: PBT

単位 : mm UNIT: mm

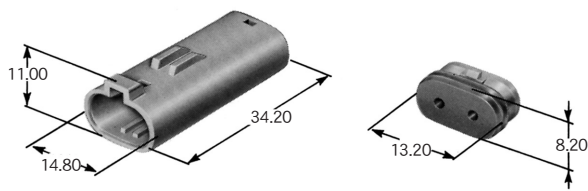
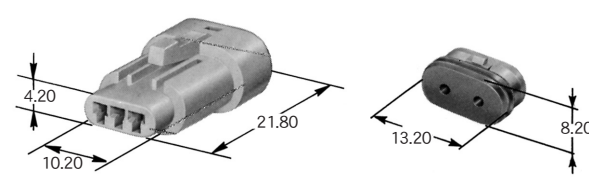
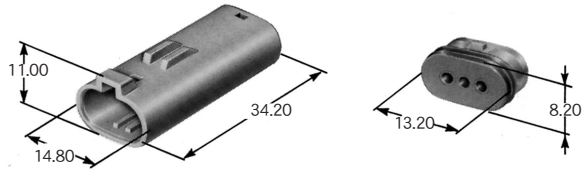
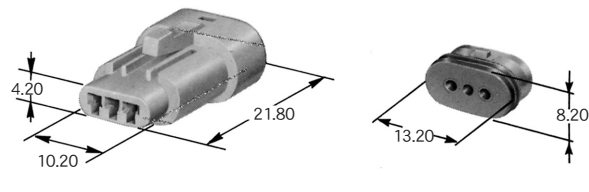
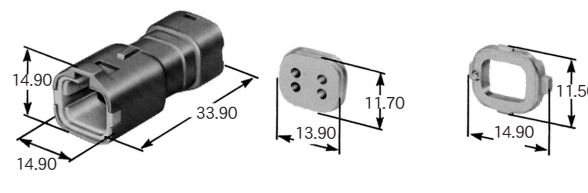
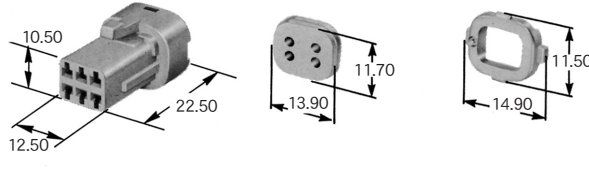
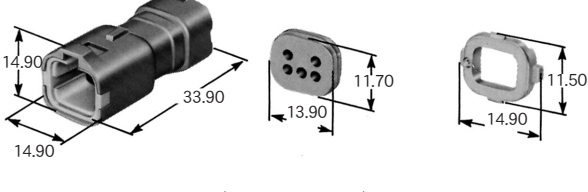
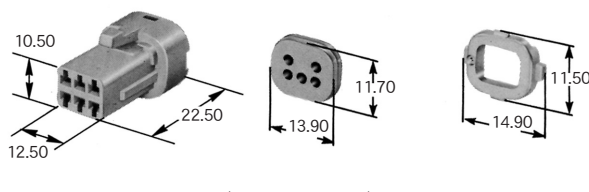
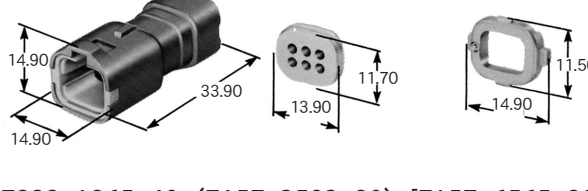
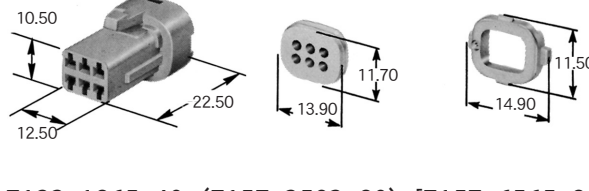
極数 POLES	M ハウジング MALE HOUSING	F ハウジング FEMALE HOUSING
2	 <p>V03MW-02</p> <p>7222-1835[7157-3597-60]</p>	 <p>V03FW-02</p> <p>7123-1835[7157-3597-60]</p>
3	 <p>V03MW-03</p> <p>7222-1835[7157-3596-30]</p>	 <p>V03FW-03</p> <p>7123-1835[7157-3596-30]</p>
4	 <p>V06MGY-04</p> <p>7222-1865-40 (7157-3595-60) [7157-6565-80]</p>	 <p>V06FGY-04</p> <p>7123-1865-40 (7157-3595-60) [7157-6565-80]</p>
5	 <p>V06MGY-05</p> <p>7222-1865-40 (7157-3594) [7157-6565-80]</p>	 <p>V06FGY-05</p> <p>7123-1865-40 (7157-3594) [7157-6565-80]</p>
6	 <p>V06MGY-06</p> <p>7222-1865-40 (7157-3593-80) [7157-6565-80]</p>	 <p>V06FGY-06</p> <p>7123-1865-40 (7157-3593-80) [7157-6565-80]</p>

()は防水栓品番 WIRE SEAL PART NUMBER IN PARENTHESIS()

〔 〕は、リヤホルダ品番 REAR HOLDER PART NUMBER IN PARENTHESIS〔 〕

2P, 3P はリヤホルダー一体型防水栓 2P AND 3P ARE REAR HOLDER INTEGRATED WIRE SEAL