

CKT. SIZE	DIM. "A"		DIM. "B"	
	MM	IN.	MM	IN.
2	2.54	.100	5.33±0.08	.210±.003
3	5.08	.200	8.13±0.10	.320±.004
4	7.62	.300	10.67±0.10	.420±.004
5	10.16	.400	13.21±0.10	.520±.004
6	12.70	.500	15.75±0.10	.620±.004
7	15.24	.600	18.29±0.10	.720±.004
8	17.78	.700	20.83±0.10	.820±.004
9	20.32	.800	23.37±0.10	.920±.004
10	22.86	.900	25.91±0.13	1.020±.005
11	25.40	1.000	28.45±0.13	1.120±.005
12	27.94	1.100	30.99±0.13	1.220±.005
13	30.48	1.200	33.53±0.13	1.320±.005
14	33.02	1.300	36.07±0.13	1.420±.005
15	35.56	1.400	38.61±0.15	1.520±.006
16	38.10	1.500	41.15±0.15	1.620±.006
17	40.64	1.600	43.69±0.15	1.720±.006
18	43.18	1.700	46.23±0.15	1.820±.006
19	45.72	1.800	48.77±0.18	1.920±.007
20	48.26	1.900	51.31±0.18	2.020±.007
21	50.80	2.000	53.85±0.18	2.120±.007
22	53.34	2.100	56.39±0.18	2.220±.007
23	55.88	2.200	58.93±0.18	2.320±.007
24	58.42	2.300	61.47±0.18	2.420±.007
25	60.96	2.400	64.01±0.20	2.520±.008

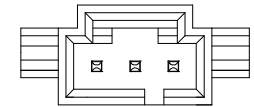

- NOTES:
- MATERIAL: HOUSING: GLASS FILLED POLYESTER; UL94V-0 COLOR: BLACK. PIN MATERIAL: PHOSPHOR BRONZE.
 - HEADER TO BE USED WITH OPTION "G" 70400 AND 70430 SERIES SL CONNECTORS.
 - REFER TO MOLEX PRODUCT SPECIFICATION PS-70541.
 - STANDARD PACKAGING PER PK-70873-0014.

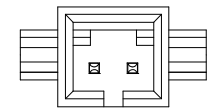
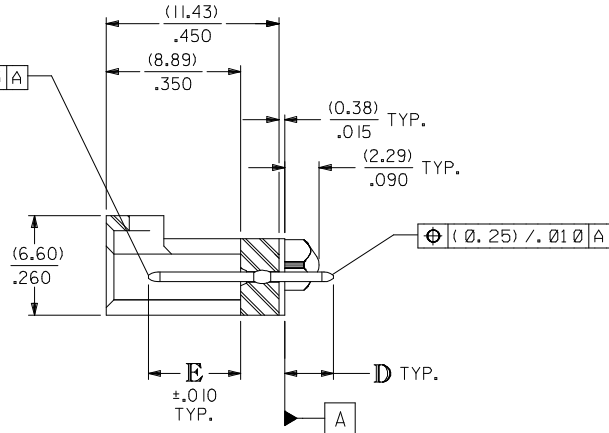
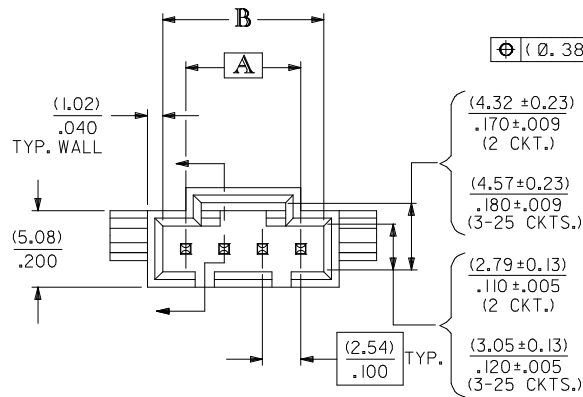
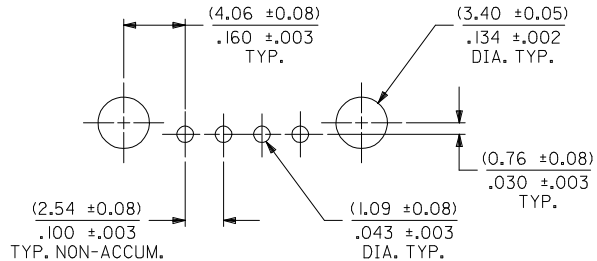

RECOMMENDED PC BOARD LAYOUT
(FOR USE WITH (1.57)/.062 THICK BOARD)

PLATING:

- TIN - .000150 MINIMUM TIN PLATE OVER .000050 MINIMUM NICKEL PLATE.
- 15 GOLD - .000015 MINIMUM GOLD PLATE IN SELECT AREA, .000075 MINIMUM TIN PLATE IN SELECT AREA, OVER .000050 MINIMUM NICKEL PLATE OVERALL.
- 30 GOLD - .000030 MINIMUM GOLD PLATE IN SELECT AREA, .000075 MINIMUM TIN PLATE IN SELECT AREA, OVER .000050 MINIMUM NICKEL PLATE OVERALL.

REMOVE DIM H, K & NOTE 5 EC NO: UCP2016-0427 DRWNSVANG01 2015/07/30 CHKD:ADORGAN 2015/07/30 APPR:SMILLER 2016/02/19	DESCRIPTION REV	QUALITY SYMBOLS	GENERAL TOLERANCES (UNLESS SPECIFIED)	DIMENSION STYLE	SCALE	DESIGN UNITS	THIRD ANGLE PROJECTION
		▽=0	mm INCH	MM/IN	INCH	INCH	
		▽=0	4 PLACES ± --- ± ---	DRAWN BY DATE	TITLE		
		▽=0	3 PLACES ± --- ± .005	RBADAMS 07/19/2004	SALES ASSY, SL VERTICAL HEADER W/LATCH&TRI-PEGS (2.54)/.100 CENTERS		
		2 PLACES ± 0.13 ± .01	CHECKED BY DATE				
		1 PLACE ± 0.25 ± ---	BBARKER 07/19/2004				
		0 PLACE ± --- ± ---	APPROVED BY DATE				
			SMILLER 2013/07/22				
			ANGULAR ±1/2°	MATERIAL NO.	DOCUMENT NO.		
			DRAFT WHERE APPLICABLE MUST REMAIN WITHIN DIMENSIONS	SEE TABLE	SD-70545-001		
				SIZE C			
				THIS DRAWING CONTAINS INFORMATION THAT IS PROPRIETARY TO MOLEX INCORPORATED AND SHOULD NOT BE USED WITHOUT WRITTEN PERMISSION			

OPTIONAL HOUSING

WEBBED KEYING FEATURES



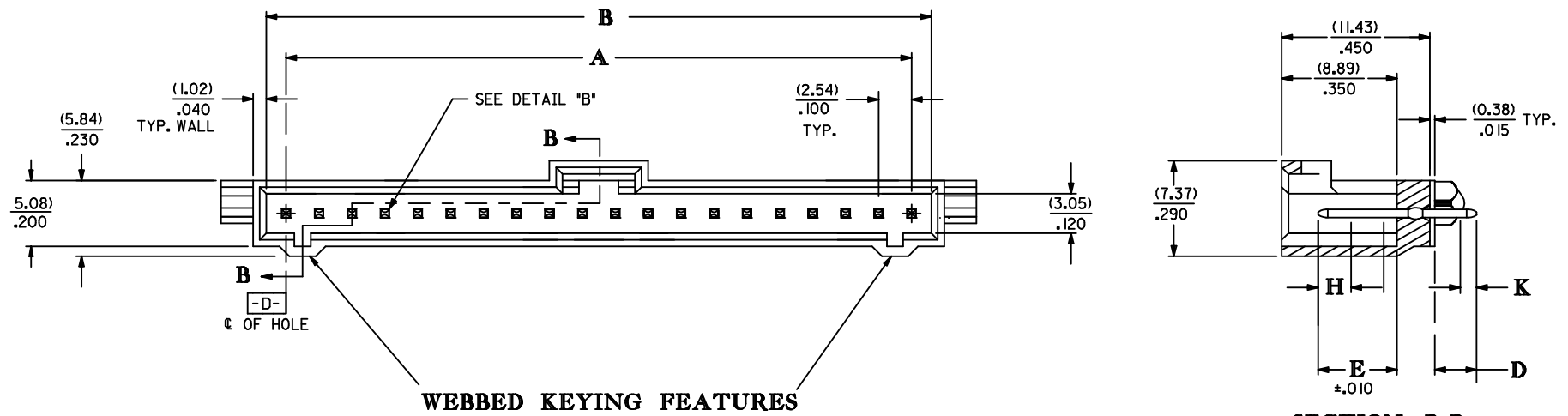
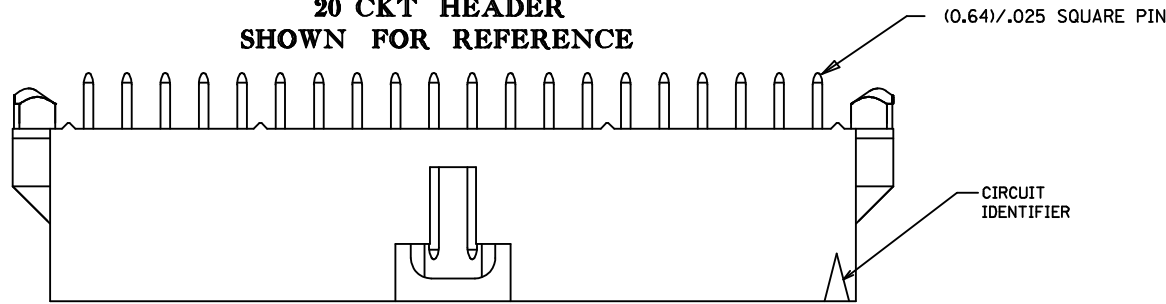

20 CKT HEADER
SHOWN FOR REFERENCE



SEE SHEET 1 EC NO: UCP2016-0427 DRWNSVANG01 2015/07/30 CHKD:DMORGAN 2015/07/30 APPR:SMILLER 2016/02/19	QUALITY SYMBOLS ▽=0 ▽=0 ▽=0	GENERAL TOLERANCES (UNLESS SPECIFIED)		DIMENSION STYLE MM/IN		SCALE 1:1	DESIGN UNITS INCH	THIRD ANGLE PROJECTION		
		4 PLACES	± ---	± ---	DRAWN BY	DATE	TITLE SALES ASSY, SL VERTICAL HEADER W/LATCH&TRI-PEGS (2.54) / .100 CENTERS molex			
		3 PLACES	± ---	± .005	CHECKED BY	DATE				
		2 PLACES	± 0.13	± .01	APPROVED BY		DATE	DOCUMENT NO.		SHEET NO.
1 PLACE	± 0.25	± ---	SMILLER		2013/07/22	SD-70545-001		2 OF 4		
0 PLACE	± ---	± ---	ANGULAR ±1/2°		SEE TABLE		THIS DRAWING CONTAINS INFORMATION THAT IS PROPRIETARY TO MOLEX INCORPORATED AND SHOULD NOT BE USED WITHOUT WRITTEN PERMISSION			
DRAFT WHERE APPLICABLE MUST REMAIN WITHIN DIMENSIONS			SIZE							

CIRCUIT SIZE	ASSEMBLY ITEM NUMBER 70545		D (± 0.38) ± .015	E (± 0.25) ± .010	MATING AREA FINISH	PC TAIL AREA FINISH
			(3.30) .130	(6.10) .240	15 GOLD	TIN
2-10	-9036 TO -9044		(3.30) .130	(6.10) .240	15 GOLD	TIN
11-13	-9045 TO -9047		(3.30) .130	(6.10) .240	15 GOLD	TIN
14	-9048		(3.30) .130	(6.10) .240	15 GOLD	TIN
15-25	-9049 TO -9059		(3.30) .130	(6.10) .240	15 GOLD	TIN
3-4	-9072 to -9073		(3.30) .130	(6.10) .240	30 GOLD	TIN
8	-9077		(3.30) .130	(6.10) .240	30 GOLD	TIN
10	-9079		(3.30) .130	(6.10) .240	30 GOLD	TIN
12-13	-9081 to -9082		(3.30) .130	(6.10) .240	30 GOLD	TIN
18	-9087		(3.30) .130	(6.10) .240	30 GOLD	TIN

CIRCUIT SIZE	ASSEMBLY ITEM NUMBER	ASSEMBLY ITEM NUMBER	ASSEMBLY ITEM NUMBER	ASSEMBLY ITEM NUMBER	ASSEMBLY ITEM NUMBER
2		70545-9036			
3		70545-9037	70545-9072		
4		70545-9038	70545-9073		
5		70545-9039			
6		70545-9040			
7		70545-9041			
8		70545-9042	70545-9077		
9		70545-9043			
10		70545-9044	70545-9079		
11		70545-9045			
12		70545-9046	70545-9081		
13		70545-9047	70545-9082		
14		70545-9048			
15		70545-9049			
16		70545-9050			
17					
18		70545-9052	70545-9087		
19					
20		70545-9054			
21					
22					
23					
24					
25					

SEE SHEET 1 EC NO: UCP2016-0427 DRWNS:VANG01 2015/07/30 CHKD:DMORGAN 2015/07/30 APPR:SMILLER 2016/02/19	QUALITY SYMBOLS  = 0  = 0  = 0	GENERAL TOLERANCES (UNLESS SPECIFIED)		DIMENSION STYLE MM/IN	SCALE INCH	DESIGN UNITS INCH	 THIRD ANGLE PROJECTION		
		4 PLACES ± --- ± --- 3 PLACES ± --- ± .005 2 PLACES ± 0.13 ± .01 1 PLACE ± 0.25 ± --- 0 PLACE ± --- ± ---	mm INCH DRAWN BY DATE RKADAMS 07/19/2004 CHECKED BY DATE BBARKER 07/19/2004 APPROVED BY DATE SMILLER 2013/07/22	TITLE SALES ASSY, SL VERTICAL HEADER W/LATCH&TRI-PEGS (2.54)/.100 CENTERS				MATERIAL NO. SD-70545-001	SHEET NO. 3 OF 4
		ANGULAR ±1/2°		SEE TABLE		DOCUMENT NO.			
		DRAFT WHERE APPLICABLE MUST REMAIN WITHIN DIMENSIONS		THIS DRAWING CONTAINS INFORMATION THAT IS PROPRIETARY TO MOLEX INCORPORATED AND SHOULD NOT BE USED WITHOUT WRITTEN PERMISSION					

CIRCUIT SIZE	ASSEMBLY ITEM NUMBER 70545		D REF.	E ± .010	MATING AREA FINISH	PC TAIL AREA FINISH
2-19	-3901-3918	WEBBED ASSEMBLY	(3.30) .130	(6.10) .240	30 GOLD	TIN
20-25	-3919-3924	WEBBED ASSEMBLY	(3.30) .130	(6.10) .240	30 GOLD	TIN
2-19			(3.30) .130	(6.10) .240	15 GOLD	TIN
20-25			(3.30) .130	(6.10) .240	15 GOLD	TIN
2-19			(3.30) .130	(6.10) .240	TIN	TIN
20-25			(3.30) .130	(6.10) .240	TIN	TIN

CIRCUIT SIZE	WEBBED ASSEMBLY ITEM NUMBER	WEBBED ASSEMBLY ITEM NUMBER	WEBBED ASSEMBLY ITEM NUMBER
2			
3			
4			
5			
6			
7			
8			
9			
10			
11			
12			
13			
14			
15			
16			
17			
18			
19			
20			
21	70545-3921		
22			
23	70545-3923		
24			
25			

SEE SHEET 1 EC NO: UCP2016-0427 DRWNS:VANG01 2015/07/30 CHKD:DMORGAN 2015/07/30 APPR:SMILLER 2016/02/19	QUALITY SYMBOLS ▽=0 ▽=0 ▽=0	GENERAL TOLERANCES (UNLESS SPECIFIED)		DIMENSION STYLE MM/IN		SCALE	DESIGN UNITS INCH	THIRD ANGLE PROJECTION			
		4 PLACES ± --- ± ---	3 PLACES ± --- ± .005	2 PLACES ± 0.13 ± .01	1 PLACE ± 0.25 ± ---	0 PLACE ± --- ± ---	DRAWN BY RKADAMS	DATE 07/19/2004	TITLE SALES ASSY, SL VERTICAL HEADER W/LATCH&TRI-PEGS (2.54)/.100 CENTERS		
		ANGULAR ±1/2°					APPROVED BY SMILLER	DATE 2013/07/22	DOCUMENT NO. SD-70545-001		
		DRAFT WHERE APPLICABLE MUST REMAIN WITHIN DIMENSIONS					MATERIAL NO. SEE TABLE		SHEET NO. 4 OF 4		

THIS DRAWING CONTAINS INFORMATION THAT IS PROPRIETARY TO MOLEX INCORPORATED AND SHOULD NOT BE USED WITHOUT WRITTEN PERMISSION

OPTIONAL HOUSING

WEBBED KEYING FEATURES

20 CKT HEADER
SHOWN FOR REFERENCE

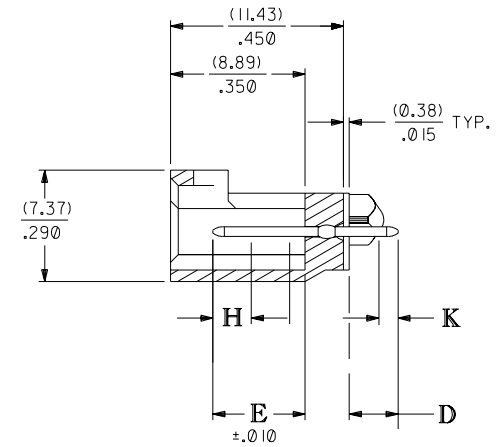
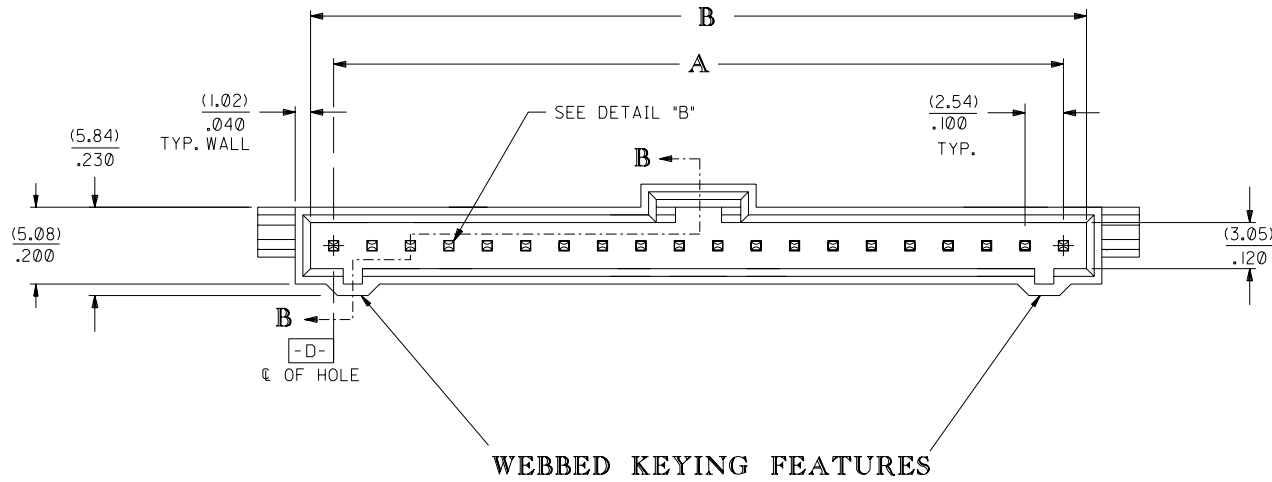
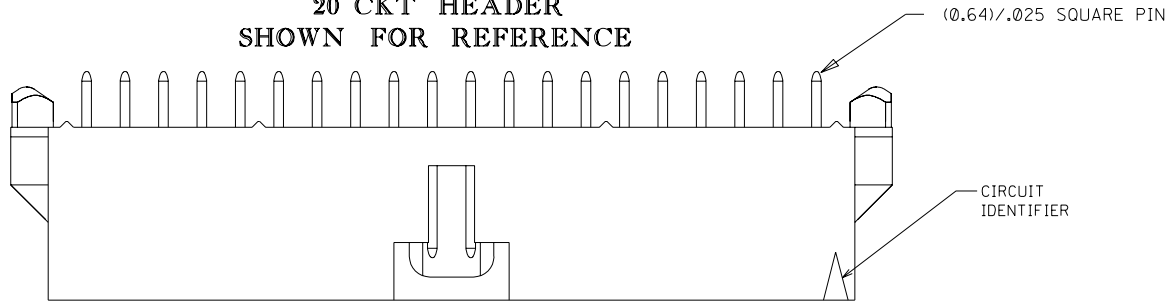

SECTION B-B

DIMENSIONS SHOWN (METRIC) INCH	
UNLESS OTHERWISE SPECIFIED TOLERANCES: ANGULAR ± 1/2°	
3 PLACE ± .005	INCH METRIC
2 PLACE ± .01 ± 0.13	
1 PLACE ± 0.25	
DRAFT WHERE APPLICABLE MUST REMAIN WITHIN DIMENSIONS	
DRWG. BY RKA	CHK'D. BY BB
APP'D. BY SM	SCALE :

▽ = 0	▼ = 0	REVISE ONLY ON CAD SYSTEM
TITLE SALES ASSY, SL VERTICAL HEADER W/LATCH & TRI-PEGS (2.54)/.100 CENTERS		
MOLEX INCORPORATED	SHEET NO. 2	DATE 04/7/19
LITSE,ILL. 60532	U.S.A.	
PART NO. SEE CHART	DRWG. NO. SD-70545-001	
FILE NAME S70545X2.DGN	THIS DRAWING CONTAINS INFORMATION THAT IS PROPRIETARY TO MOLEX INC. AND SHOULD NOT BE USED WITHOUT WRITTEN PERMISSION	DIV. DA

LTR.	REVISIONS	LTR.	REVISIONS
	A		SEE SHEET I



		13	12	11	10	9	8	7	6	5	4	3	2	1		
J	CIRCUIT SIZE	ASSEMBLY ITEM NUMBER 70545	MANUFACTURE RELEASE STATUS					D (± 0.38) ± .015	E (± 0.25) ± .010	CONNECTOR END PLATING		P.C. BOARD END PLATING				
								TYPE	H MEAS.	TYPE	K MEAS.					
I	2-10	-9036 TO -9044	R.F.M.					(3.30) .130	(6.10) .240	15	GOLD	(2.54) .100	TIN	(1.27) .050		
	11-13	-9045 TO -9047	R.F.M.													
H	14	-9048	R.F.M.					(3.30) .130	(6.10) .240	15	GOLD	(2.54) .100	TIN	(1.27) .050		
	15-25	-9049 TO -9059	R.F.M.													
G	3-4	-9072 to -9073	R.F.M.					(3.30) .130	(6.10) .240	30	GOLD	(2.54) .100	TIN	(1.27) .050		
	8	-9077	R.F.M.													
F	10	-9079	R.F.M.													
	12-13	-9081 to -9082	R.F.M.					(3.30) .130	(6.10) .240	30	GOLD	(2.54) .100	TIN	(1.27) .050		
	18	-9087	R.F.M.													

F	CIRCUIT SIZE	ASSEMBLY ITEM NUMBER	ASSEMBLY ITEM NUMBER	ASSEMBLY ITEM NUMBER	ASSEMBLY ITEM NUMBER	ASSEMBLY ITEM NUMBER
	2		70545-9036			
	3		70545-9037		70545-9072	
	4		70545-9038		70545-9073	
E	5		70545-9039			
	6		70545-9040			
	7		70545-9041			
	8		70545-9042		70545-9077	
	9		70545-9043			
	10		70545-9044		70545-9079	
	11		70545-9045			
D	12		70545-9046		70545-9081	
	13		70545-9047		70545-9082	
	14		70545-9048			
	15		70545-9049			
	16		70545-9050			
	17					
C	18		70545-9052		70545-9087	
	19					
	20		70545-9054			
	21					
	22					
	23					
B	24					
	25					

ADD 70545-90** EC NO: UCP2006-0364 DRAWNS:WART 2005/12/12 CHKD:BBARKER 2005/12/19 APPR:SMILLER 2005/12/19 REVISIONS:	QUALITY SYMBOLS	GENERAL TOLERANCES (UNLESS SPECIFIED)	DIMENSION STYLE	SCALE	DESIGN UNITS	THIRD ANGLE PROJECTION
	<input type="checkbox"/> =0 <input type="checkbox"/> =0	mm INCH	MM/IN	---	INCH	
		4 PLACES ± --- ± ---	DRAWN BY DATE	FILE		
		3 PLACES ± --- ± ---	CHKD BY DATE			
	2 PLACES ± --- ± ---	APPR BY DATE				
	1 PLACE ± --- ± ---					
	ANGULAR ± --- °					
		DRAFT WHERE APPLICABLE MUST REMAIN WITHIN DIMENSIONS	SEE TABLE	SALES ASSY, SL VERTICAL HEADER W/LATCH&TRI-PEGS (2.54)/.100 CENTERS MOLEX INCORPORATED		

	13	12	11	10	9	8	7	6	5	4	3	2	1	
J	CIRCUIT SIZE	ASSEMBLY ITEM NUMBER 70545	MANUFACTURE RELEASE STATUS	WEBBED ASSEMBLY	D REF.	E ± .010	CONNECTOR END PLATING			P.C. BOARD END PLATING				
							TYPE	H MEAS.		TYPE	K MEAS.			
	2-19	-3901-3918	NOT TOOLED	WEBBED ASSEMBLY	(3.30)	(6.10)	30 GOLD	(2.54)	.100	TIN	(1.27)	.050		
	20-25	-3919-3924	R.F.M.		.130	.240								
I	2-19		NOT TOOLED	WEBBED ASSEMBLY	(3.30)	(6.10)	15 GOLD	(2.54)	.100	TIN	(1.27)	.050		
	20-25		R.F.M.		.130	.240								
H	2-19		NOT TOOLED	WEBBED ASSEMBLY	(3.30)	(6.10)	TIN	(2.54)	.100	TIN	(1.27)	.050		
	20-25		R.F.M.		.130	.240								
G														

F	CIRCUIT SIZE	WEBBED ASSEMBLY ITEM NUMBER	WEBBED ASSEMBLY ITEM NUMBER	WEBBED ASSEMBLY ITEM NUMBER									
E	2												
	3												
	4												
	5												
	6												
	7												
	8												
	9												
	10												
	11												
	12												
	13												
	14												
	15												
	16												
	17												
	18												
	19												
	20												
	21	70545-3921											
	22												
	23	70545-3923											
	24												
	25												

ADD -3921-3923 EC NO: UCP2006-0364 DRAWNSMART 2005/12/12 CHKD:BBARKER 2005/12/19 APPR:SMILLER 2005/12/19 REVISIONS	QUALITY SYMBOLS  = 0  = 0	GENERAL TOLERANCES (UNLESS SPECIFIED)		DIMENSION STYLE MM/IN		SCALE ---	DESIGN UNITS INCH	 THIRD ANGLE PROJECTION
		4 PLACES ± --- ± --- 3 PLACES ± --- ± .005 2 PLACES ± 0.13 ± .01 1 PLACE ± 0.25 ± --- ANGULAR ±1/2°	DRAWN BY RKA	DATE 2004/17/19	CHECKED BY BB	DATE 2004/17/19	APPROVED BY SM	DATE 2004/17/19
DRAFT WHERE APPLICABLE MUST REMAIN WITHIN DIMENSIONS		MATERIAL NO. SEE TABLE		DOCUMENT NO. SD-70545-001		SHEET NO. 4 OF 4		