

63127-1 ✓ ACTIVE

FASTON | FASTON 250

TE Internal #: 63127-1

Quick Disconnects, Receptacle, 22 – 18 AWG Wire Size, .32 – .82 mm² Wire Size, Mating Tab Width .25 in [6.35 mm], Straight, Brass, FASTON 250

[View on TE.com >](#)



Terminals & Splices > Quick Disconnects



Quick Disconnect Terminal Type: **Receptacle**

Wire Size: .32 – .82 mm²

Mating Tab Width: 6.35 mm [.25 in]

Mating Tab Thickness: .81 mm [.032 in]

Features

Product Type Features

Terminates To	Wire & Cable
Wire Stop	No
Wire/Cable Type	Regular Wire
Insertion Force	Normal
Sealable	No

Configuration Features

Connection Capacity	Single
---------------------	--------

Contact Features

Quick Disconnect Terminal Type	Receptacle
Mating Tab Width	6.35 mm [.25 in]
Mating Tab Thickness	.81 mm [.032 in]
Terminal Orientation	Straight
Contact Base Material	Brass
Terminal Plating Material	Unplated
Crimp Type	F-Crimp



Barrel Type	Open
-------------	------

Mechanical Attachment

Mating Retention Type	Dimple
Wire Insulation Support	With

Dimensions

Accepts Wire Insulation Diameter Range	2.29 – 3.3 mm [.09 – .13 in]
Overall Length	19.18 mm [.755 in]
Receptacle Terminal Stock Thickness	.41 mm [.016 in]
Wire Size	.32 – .82 mm ²

Usage Conditions

Insulation Option	Uninsulated
Operating Temperature Range	-40 – 110 °C [-40 – 230 °F]

Industry Standards

UL Rating	Listed
-----------	--------

Packaging Features

Packaging Quantity	10000
Packaging Method	Strip/Reel

Product Compliance









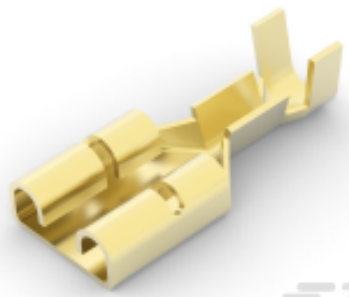
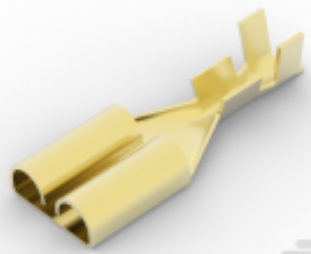

[For compliance documentation, visit the product page on TE.com>](#)

EU RoHS Directive 2011/65/EU	Compliant
EU ELV Directive 2000/53/EC	Compliant
China RoHS 2 Directive MIIT Order No 32, 2016	No Restricted Materials Above Threshold
EU REACH Regulation (EC) No. 1907/2006	Current ECHA Candidate List: JUNE 2022 (224) Candidate List Declared Against: JAN 2021 (211) SVHC > Threshold: Not Yet Reviewed
Halogen Content	Low Halogen - Br, Cl, F, I < 900 ppm per homogenous material. Also BFR/CFR/PVC Free
Solder Process Capability	Not applicable for solder process capability

Product Compliance Disclaimer

This information is provided based on reasonable inquiry of our suppliers and represents our current actual knowledge based on the information they provided. This information is subject to change. The part numbers that TE has identified as EU RoHS compliant have a maximum concentration of 0.1% by weight in homogenous materials for lead, hexavalent chromium, mercury, PBB, PBDE, DBP, BBP, DEHP, DIBP, and 0.01% for cadmium, or qualify for an exemption to these limits as defined in the Annexes of Directive 2011/65/EU (RoHS2). Finished electrical and electronic equipment products will be CE marked as required by Directive 2011/65/EU. Components may not be CE marked. Additionally, the part numbers that TE has identified as EU ELV compliant have a maximum concentration of 0.1% by weight in homogenous materials for lead, hexavalent chromium, and mercury, and 0.01% for cadmium, or qualify for an exemption to these limits as defined in the Annexes of Directive 2000/53/EC (ELV). Regarding the REACH Regulation, the information TE provides on SVHC in articles for this part number is based on the latest European Chemicals Agency (ECHA) 'Guidance on requirements for substances in articles' posted at this URL: <https://echa.europa.eu/guidance-documents/guidance-on-reach>

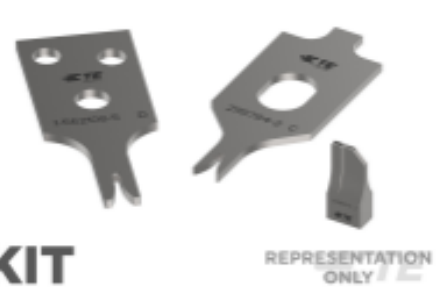
Compatible Parts

 <p>TE Part # 444334-3 250 FASTON REC 22-18 AWG BR</p>	 <p>TE Part # 170304-2 250 FASTON,REC.,22-18 AWG,BR</p>	 <p>TE Part # 90166-1 DAHT 250 FASTON REC 22-18 ASSY</p>	 <p>TE Part # 2-2150030-1 OCEAN_2.0_Applicator-E-090F130F</p>
 <p>TE Part # 2-2150030-2 OCEAN_2.0_Applicator-E-090F130F</p>	 <p>TE Part # 2150030-1 OCEAN_2.0_Applicator-E-090F130F</p>	 <p>TE Part # 2150030-2 OCEAN_2.0_Applicator-E-090F130F</p>	 <p>TE Part # 7-2150030-1 OCEAN_2.0_Applicator-E-090F130F</p>
 <p>TE Part # 7-2150030-2 OCEAN_2.0_Applicator-E-090F130F</p>	 <p>KIT TE Part # 7-2150030-7 OCEAN_2.0_SPARE_PART_KIT-090F130F</p>	 <p>TE Part # 169400 CERTI-LOK</p>	

Also in the Series | **FASTON 250**



Compression Connectors(4)



Crimp Terminal Housings(143)



Insertion & Extraction Tools(6)



Magnet Wire Terminals(1)



PCB Terminals(144)



Quick Disconnects(456)



Splices(4)

Customers Also Bought



TE Part #1-770849-0
10P SL156 HSG W/LCK RMP & TABS

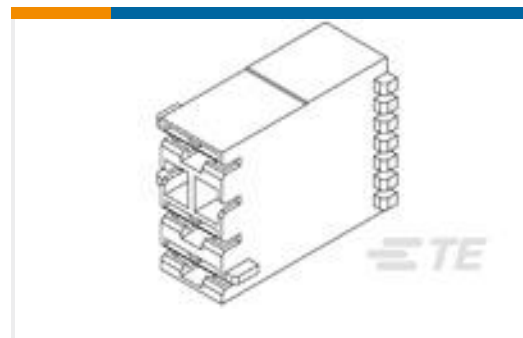

TE Part #521295-1
HOUSING, POSITIVE LOCK, RAST



TE Part #1217094-2
RCPT 250 POS-LOCK 18-14 TPBR

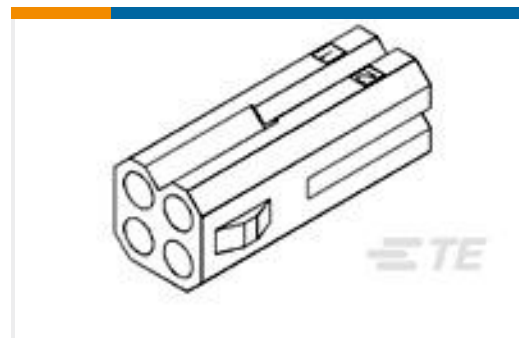

TE Part #770538-1
04P .062 COMM P&S PLUG



TE Part #521212-1
ULTRA-POD 187 ASSY REC 18-14 AWG TPBR



TE Part #1586853-1
09P UMNL CAP HSG, GW



TE Part #1217092-2
PL 250 TERMINAL REC 16-12 AWG TPBR



TE Part #60650-1
250 FASTON FLAG REC 18-14 AWG BR

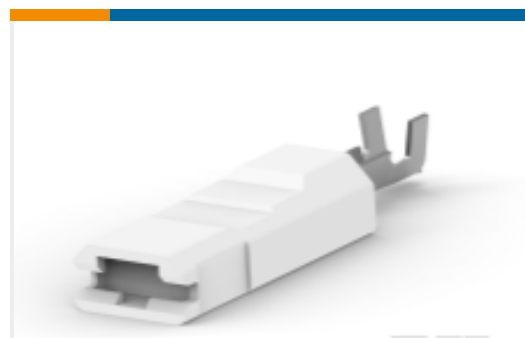

TE Part #520988-3
ULTRA-POD 250 ASSY REC 22-18 AWG TPBR

Documents



Product Drawings

250 FASTON REC 22-18 AWG BR

English

CAD Files

Customer View Model

[ENG_CVM_CVM_63127-1_M.2d_dxf.zip](#)

English

3D PDF

3D

Customer View Model

[ENG_CVM_CVM_63127-1_M.3d_igs.zip](#)

English

Customer View Model

[ENG_CVM_CVM_63127-1_M.3d_stp.zip](#)

English

By downloading the CAD file I accept and agree to the [Terms and Conditions](#) of use.

Datasheets & Catalog Pages

82004 FASTON Terminals (Insulated and Uninsulated) Catalog - FASTON Receptacles Section

English

Product Specifications

Application Specification

English

Product Environmental Compliance

TE Material Declaration

English