

61117-4 ✓ ACTIVE

MATE-N-LOK | Commercial MATE-N-LOK

TE Internal #: 61117-4

Power Contacts, Contact, 250 VAC, Tin, 20 – 14 AWG Wire Size, .52
– 2.08 mm² Wire Size, Wire-to-Wire, Wire & Cable, Crimp,
Commercial MATE-N-LOK

[View on TE.com >](#)



Connectors > Power Connectors > Power Contacts



Power Contact Type: **Contact**

Operating Voltage: **250 VAC**

Contact Mating Area Plating Material: **Tin**

Wire Size: **.52 – 2.08 mm²**

Features

Product Type Features

Power Contact Type	Contact
Connector System	Wire-to-Wire
Connector & Contact Terminates To	Wire & Cable

Electrical Characteristics

Operating Voltage	250 VAC
-------------------	---------

Contact Features

Contact Shape & Form	Round
Contact Mating Area Plating Material	Tin
Contact Current Rating (Max)	15 A
Contact Type	Socket
Contact Retention Within Housing	With
Mating Pin Diameter	2.13 mm [.084 in]
Contact Base Material	Phosphor Bronze
Wire Contact Termination Area Plating Thickness	.508 – .812 μm [20 – 32 μin]
Wire Contact Termination Area Plating Material	Tin



Contact Orientation	Straight
Barrel Type	Open Barrel

Termination Features

Termination Method to Wire & Cable	Crimp
------------------------------------	-------

Mechanical Attachment

Contact Retention Type Within Housing	Locking Lance
Connector Mounting Type	Cable Mount (Free-Hanging)
Wire Insulation Support	Without

Dimensions

Wire Size	.52 – 2.08 mm ²
Accepts Wire Insulation Diameter Range	3.3 mm [.13 in]

Usage Conditions

Operating Temperature Range	-55 – 105 °C [-67 – 221 °F]
-----------------------------	-----------------------------

Operation/Application

Circuit Application	Power
---------------------	-------

Industry Standards

Glow Wire Rating	Standard Part - Not Glow Wire
VDE Tested	No

Packaging Features

Packaging Method	Reel
Packaging Quantity	5000

Other

Wire/Cable Type	Discrete Wire
Wire Type	Stranded
For Use With	Commercial MATE-N-LOK

Product Compliance

For compliance documentation, visit the product page on [TE.com](https://www.te.com)>

EU RoHS Directive 2011/65/EU	Compliant
EU ELV Directive 2000/53/EC	Compliant
China RoHS 2 Directive MIIT Order No 32, 2016	No Restricted Materials Above Threshold



EU REACH Regulation (EC) No. 1907/2006

Current ECHA Candidate List: JUNE 2022
(224)

Candidate List Declared Against: JAN 2022
(223)

SVHC > Threshold:
Not Yet Reviewed

Halogen Content

Low Halogen - Br, Cl, F, I < 900 ppm per homogenous material. Also BFR/CFR/PVC Free

Solder Process Capability

Not applicable for solder process capability

Product Compliance Disclaimer

This information is provided based on reasonable inquiry of our suppliers and represents our current actual knowledge based on the information they provided. This information is subject to change. The part numbers that TE has identified as EU RoHS compliant have a maximum concentration of 0.1% by weight in homogenous materials for lead, hexavalent chromium, mercury, PBB, PBDE, DBP, BBP, DEHP, DIBP, and 0.01% for cadmium, or qualify for an exemption to these limits as defined in the Annexes of Directive 2011/65/EU (RoHS2). Finished electrical and electronic equipment products will be CE marked as required by Directive 2011/65/EU. Components may not be CE marked. Additionally, the part numbers that TE has identified as EU ELV compliant have a maximum concentration of 0.1% by weight in homogenous materials for lead, hexavalent chromium, and mercury, and 0.01% for cadmium, or qualify for an exemption to these limits as defined in the Annexes of Directive 2000/53/EC (ELV). Regarding the REACH Regulation, the information TE provides on SVHC in articles for this part number is based on the latest European Chemicals Agency (ECHA) 'Guidance on requirements for substances in articles' posted at this URL: <https://echa.europa.eu/guidance-documents/guidance-on-reach>

Compatible Parts





Also in the Series | Commercial MATE-N-LOK

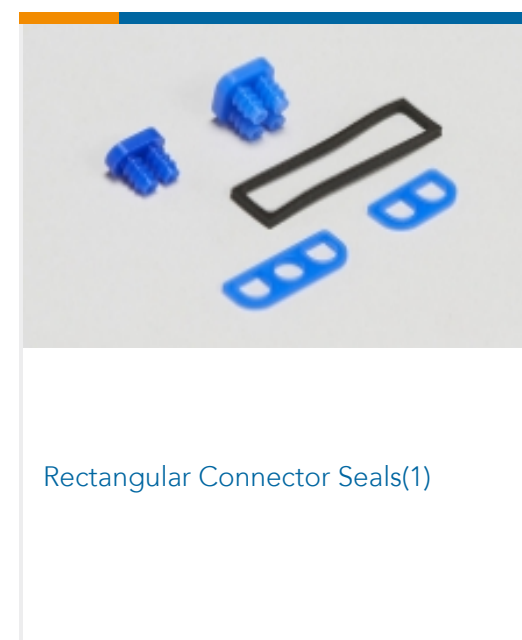
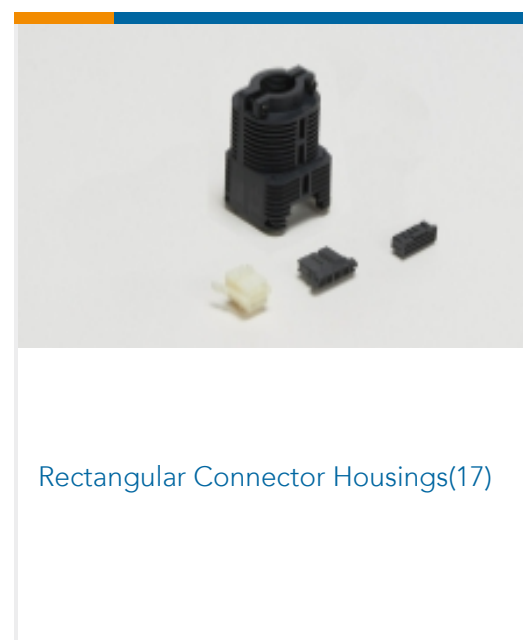
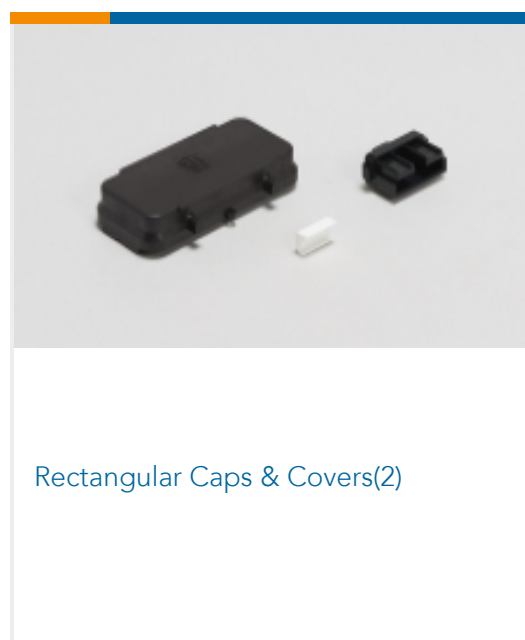
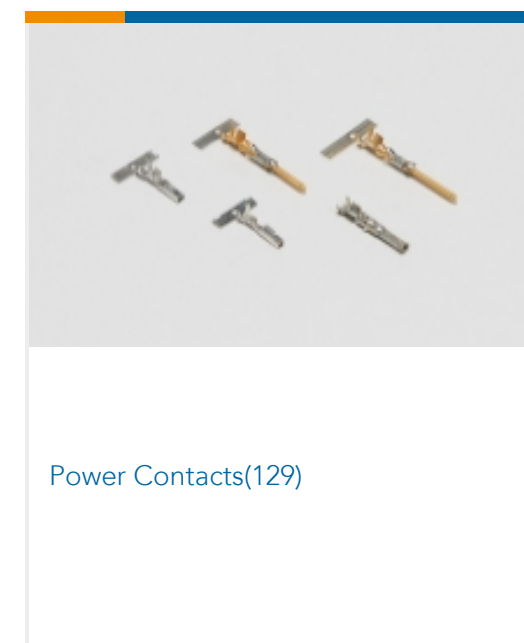
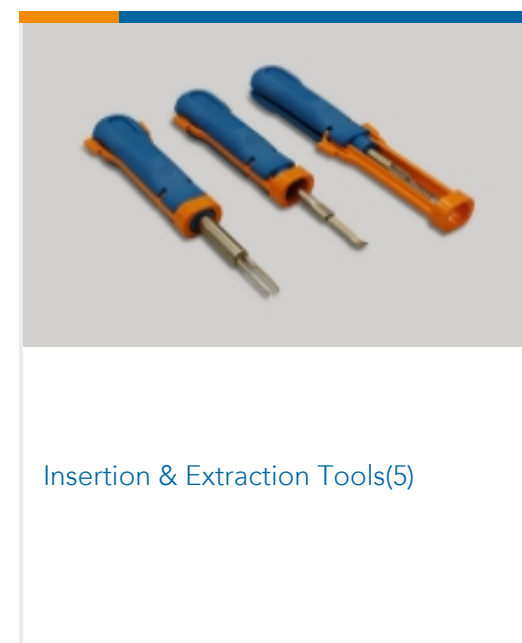
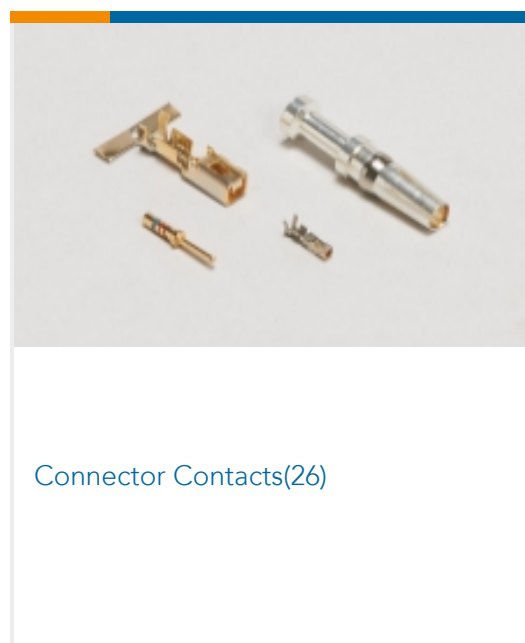



Standard Circular Connectors(4)

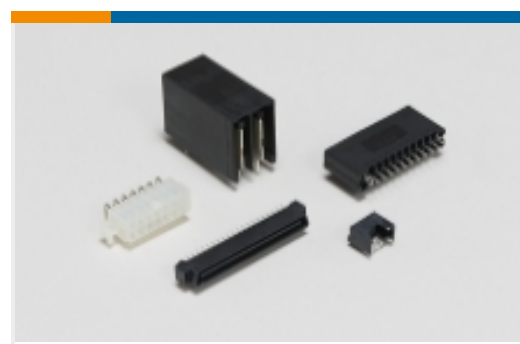

Standard Rectangular Connectors(10)



Wire-to-Board Connector Contacts(1)

Customers Also Bought



TE Part #60583-2
250 FASTON FLAG REC 12-10 AWG
TPBR



TE Part #63688-1
250 FASTON REC 18-14 AWG NPST

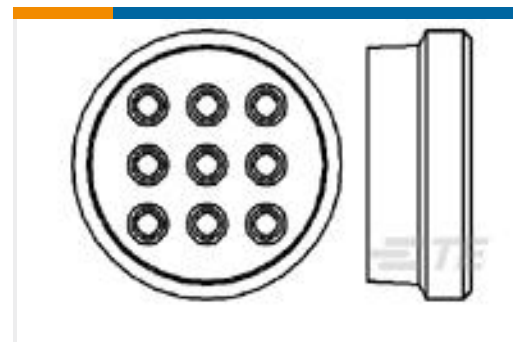

TE Part #213926-1
CPC SEAL ASSY KIT,RH,SR 1,13-9

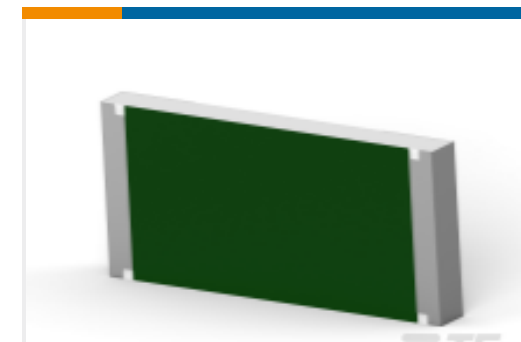

TE Part #2-2176405-0
3550 10K 5%

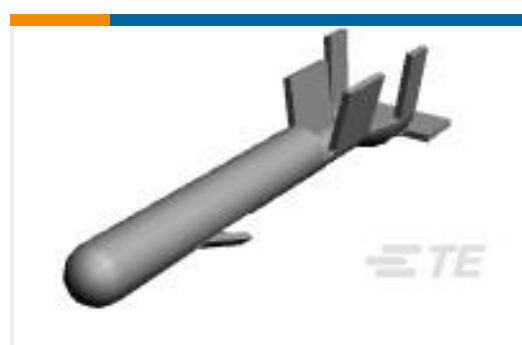

TE Part #61118-6
CMNL PIN 20-14 AUNIPHBZ



TE Part #40777
RING TERMINAL 20-16 AWG BR



TE Part #6-1437624-6
PKG60B1/8=KNOB PLASTIC BLK 1/8



TE Part #60419-2
250 FASTON FLAG REC 18-14 AWG
TPBR



TE Part #1483354-3
MICRO-MATCH LEAD 12P 250MM



TE Part #1483354-2
MICRO-MATCH LEAD 12P 150MM

Documents

Product Drawings

[CMNL SOK 20-14 TPPHBZ](#)

English

CAD Files

[3D PDF](#)

English

Customer View Model

[ENG_CVM_61117-4_AC.2d_dxf.zip](#)



English

Customer View Model

[ENG_CVM_61117-4_AC.3d_igs.zip](#)

English

Customer View Model

[ENG_CVM_61117-4_AC.3d_stp.zip](#)

English

3D PDF

3D

Customer View Model

[ENG_CVM_CVM_61117-4_BJ.2d_dxf.zip](#)

English

Customer View Model

[ENG_CVM_CVM_61117-4_BJ.3d_igs.zip](#)

English

Customer View Model

[ENG_CVM_CVM_61117-4_BJ.3d_stp.zip](#)

English

By downloading the CAD file I accept and agree to the [Terms and Conditions](#) of use.

Datasheets & Catalog Pages

[SOFT_SHELL_PIN_SOCKET_CONNECTORS_STANDARD_DENSITY](#)

English

Product Specifications

[Application Specification](#)

English

Product Environmental Compliance

[MD_61117-4_112520182253_dmtec](#)

English

[MD_61117-4_112520182253_dmtec](#)

English