

5646956-3 ✓ ACTIVE

Z-PACK 2mm HM

TE Internal #: 5646956-3

Rectangular Power Connectors, Header, Plug, Board-to-Board, 6 Position, .118 in [3 mm] Centerline, Printed Circuit Board, UL 94V-0, Z-PACK 2mm HM

[View on TE.com >](#)



Connectors > Power Connectors > Rectangular Power > Rectangular Power Connectors

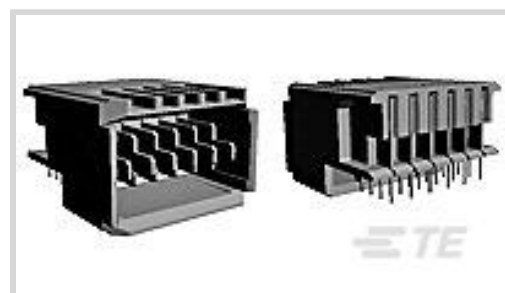

Rectangular Power Connector Type: **Header**

Connector & Housing Type: **Plug**

Connector System: **Board-to-Board**

Number of Positions: **6**

Centerline (Pitch): **3 mm [.118 in]**

Features

Product Type Features

Header Type	Fully Shrouded
Rectangular Power Connector Type	Header
Connector & Housing Type	Plug
Connector System	Board-to-Board
Sealable	No
Connector & Contact Terminates To	Printed Circuit Board

Configuration Features

Number of Positions	6
Interface Type	2mm HM
PCB Mount Orientation	Right Angle
Number of Power Positions	6
Number of Signal Positions	0
Number of Rows	0

Electrical Characteristics

Operating Voltage	30 VDC
-------------------	--------

Contact Features

Contact Base Material	Phosphor Bronze
Contact Current Rating (Max)	10 A



Contact Retention Within Housing	With
Contact Type	Blade
PCB Contact Termination Area Plating Material	Tin
Contact Mating Area Plating Material	Noble Metal
Contact Mating Area Plating Material Thickness	1.27 μm [50 μin]
Contact Termination Area Plating Thickness	3.81 – 8.89 μm [150 – 350 μin]

Termination Features

Termination Post & Tail Length	3.43 mm[.135 in]
Termination Method to Printed Circuit Board	Through Hole - Press-Fit

Mechanical Attachment

Connector Mounting Type	Board Mount
-------------------------	-------------

Housing Features

Centerline (Pitch)	3 mm[.118 in]
Housing Color	Gray
Housing Material	Polyester GF

Dimensions

PCB Thickness (Recommended)	1.6 mm[.063 in]
-----------------------------	-----------------

Usage Conditions

Operating Temperature Range	-55 – 125 $^{\circ}\text{C}$ [-67 – 257 $^{\circ}\text{F}$]
-----------------------------	--

Operation/Application

Circuit Application	Power
---------------------	-------

Industry Standards

UL Flammability Rating	UL 94V-0
Glow Wire Rating	Standard Part - Not Glow Wire

Packaging Features

Packaging Method	Box & Tube, Tube
------------------	------------------

Product Compliance

For compliance documentation, visit the product page on [TE.com](https://www.te.com)>

EU RoHS Directive 2011/65/EU	Compliant
EU ELV Directive 2000/53/EC	Out of Scope
China RoHS 2 Directive MIIT Order No 32, 2016	No Restricted Materials Above Threshold



EU REACH Regulation (EC) No. 1907/2006

Current ECHA Candidate List: JUNE 2022 (224)

Candidate List Declared Against: JAN 2022 (223)

SVHC > Threshold:
Not Yet Reviewed

Halogen Content

Not Low Halogen - contains Br or Cl > 900 ppm.

Solder Process Capability

Not applicable for solder process capability

Product Compliance Disclaimer

This information is provided based on reasonable inquiry of our suppliers and represents our current actual knowledge based on the information they provided. This information is subject to change. The part numbers that TE has identified as EU RoHS compliant have a maximum concentration of 0.1% by weight in homogenous materials for lead, hexavalent chromium, mercury, PBB, PBDE, DBP, BBP, DEHP, DIBP, and 0.01% for cadmium, or qualify for an exemption to these limits as defined in the Annexes of Directive 2011/65/EU (RoHS2). Finished electrical and electronic equipment products will be CE marked as required by Directive 2011/65/EU. Components may not be CE marked. Additionally, the part numbers that TE has identified as EU ELV compliant have a maximum concentration of 0.1% by weight in homogenous materials for lead, hexavalent chromium, and mercury, and 0.01% for cadmium, or qualify for an exemption to these limits as defined in the Annexes of Directive 2000/53/EC (ELV). Regarding the REACH Regulation, the information TE provides on SVHC in articles for this part number is based on the latest European Chemicals Agency (ECHA) 'Guidance on requirements for substances in articles' posted at this URL: <https://echa.europa.eu/guidance-documents/guidance-on-reach>

Compatible Parts



Also in the Series | Z-PACK 2mm HM

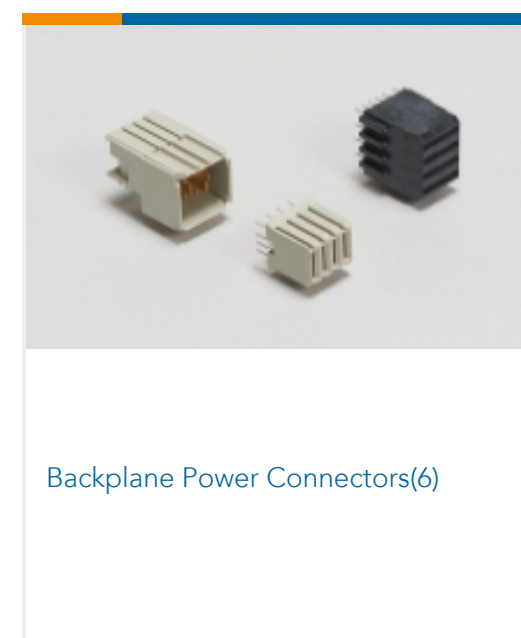
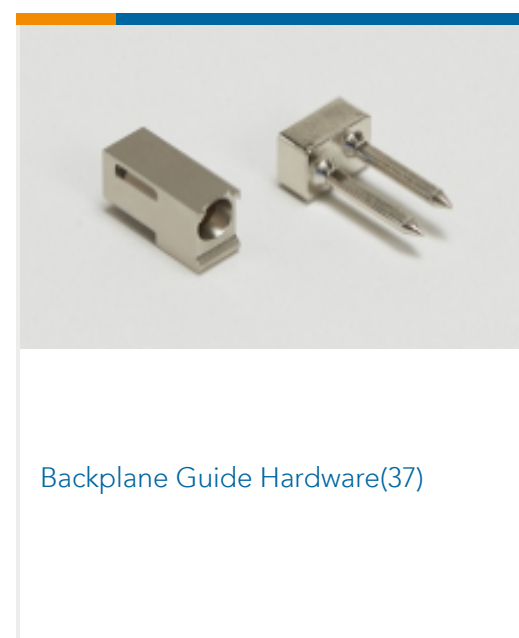
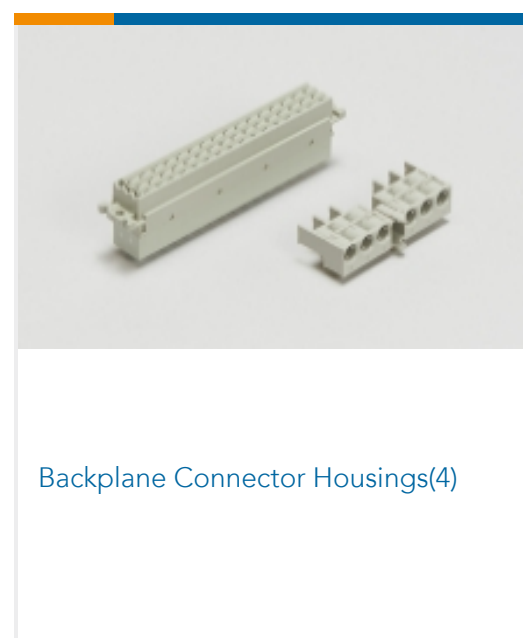
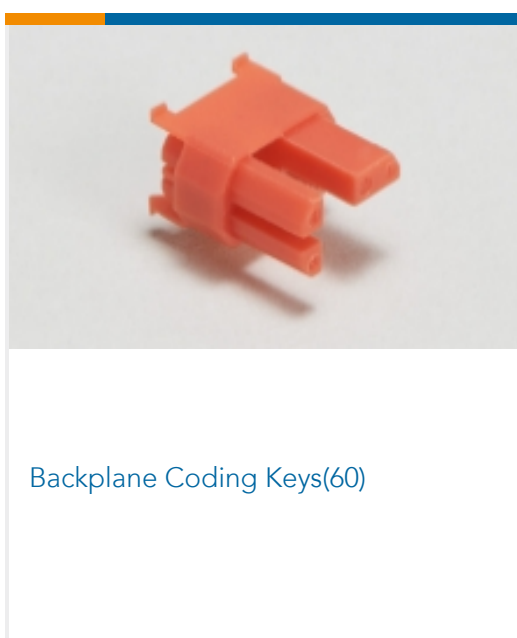



Board-to-Board Connector Contacts(2)

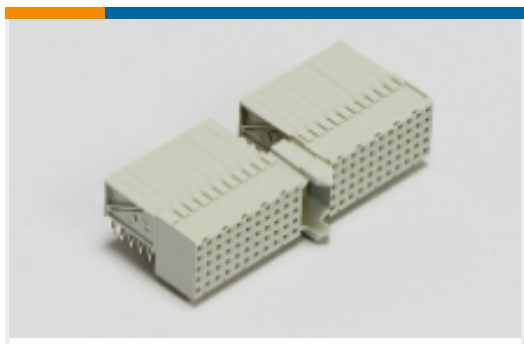

Hard Metric Backplane Connectors (269)

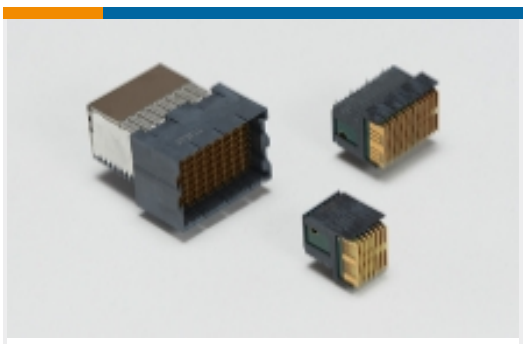

High Speed Backplane Connectors(1)



Insertion & Extraction Tools(2)



PCB Connector Covers(4)



PCB Connector Shrouds(39)



PCB Ferrules & Shields(19)



PCB Latches, Locks & Retainers(1)



Rectangular Power Connectors(87)

Customers Also Bought



TE Part #5553813-4
ASSY,EMI RCPT,50 POSN,SCR LK

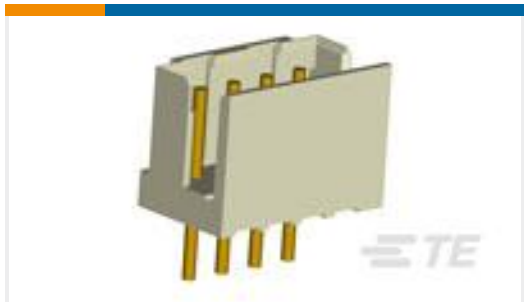

TE Part #292132-4
CT P/HDR BOX V 4P NAT

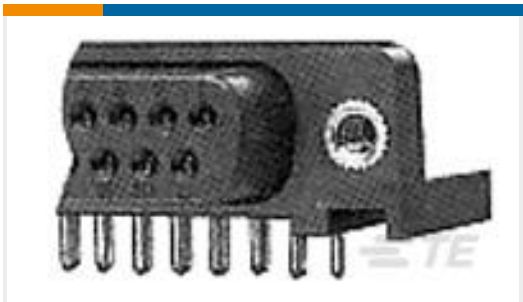

TE Part #5788796-2
09 HTMSFL ASSY RA 318 (IN,BL)



TE Part #2007250-1
SFP+ 1x6 Cage Assembly with Light Pipes



TE Part #5569256-1
STK MJ ASSY,8POS,2X3,SHLD,CAT5



TE Part #1-1734775-1
Std USB Type A, Flag, T/H, 1.8A

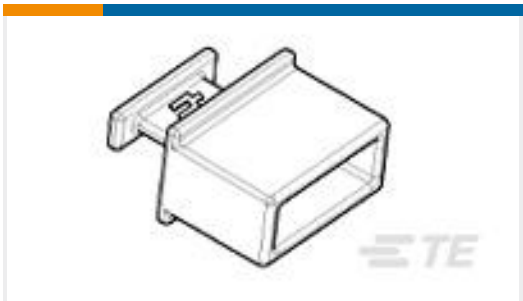

TE Part #1888810-2
EMI/Dust Cover,XFP And QSFP



TE Part #531230-2
SHUNT, .200 C/L,LP,2 POS, 15AU

Documents



CAD Files

Customer View Model

[ENG_CVM_CVM_5646956-3_C.2d_dxf.zip](#)

English

3D PDF

3D

Customer View Model

[ENG_CVM_CVM_5646956-3_C.3d_igs.zip](#)

English

Customer View Model

[ENG_CVM_CVM_5646956-3_C.3d_stp.zip](#)

English

By downloading the CAD file I accept and agree to the [Terms and Conditions](#) of use.

Datasheets & Catalog Pages

[2_PIECE_POWER_CONNECTORS_qrg_4-1773458-1](#)

English

Product Specifications

[Engineering Report](#)

English

Product Environmental Compliance

[UPM PIN ASSY, SEQUENCED, 6 POS](#)

English

[UPM PIN ASSY, SEQUENCED, 6 POS](#)

English