

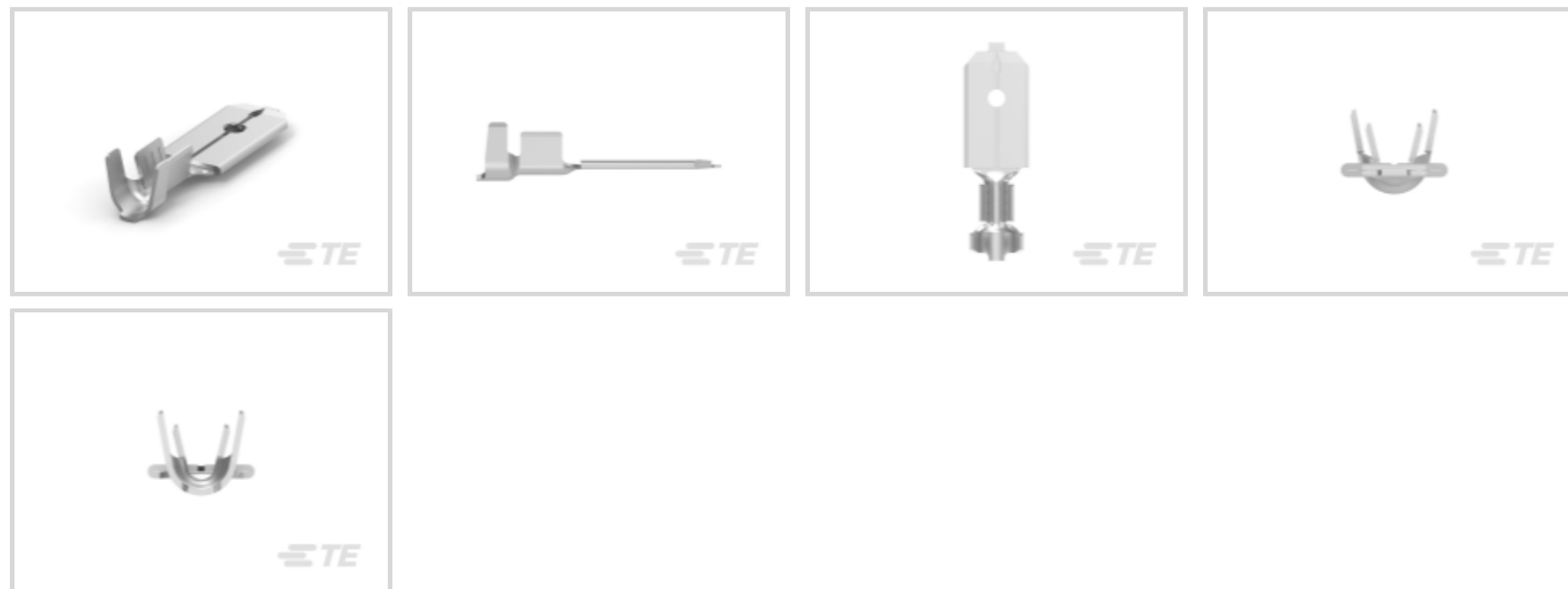

Terminals & Splices > Quick Disconnects



Quick Disconnect Terminal Type: **Tab**

Wire Size: **.82 – 2.08 mm²**

Mating Tab Width: **6.35 mm [.25 in]**

Mating Tab Thickness: **.8 mm [.031 in]**

Features

Product Type Features

Wire/Cable Type	Discrete Wire
Sealable	No

Contact Features

Quick Disconnect Terminal Type	Tab
Mating Tab Width	6.35 mm[.25 in]
Mating Tab Thickness	.8 mm[.031 in]
Terminal Orientation	Straight
Contact Base Material	Brass
Terminal Plating Material	Tin
Crimp Type	F-Crimp
Barrel Type	Open

Mechanical Attachment

Wire Insulation Support	With
-------------------------	------

Dimensions

--	--



Accepts Wire Insulation Diameter Range	2.79 – 3.81 mm [.11 – .15 in]
Receptacle Terminal Stock Thickness	.4 mm [.015 in]
Wire Size	.82 – 2.08 mm ²

Usage Conditions

Insulation Option	Uninsulated
-------------------	-------------

Packaging Features

Packaging Quantity	8000
Packaging Method	Reel

Product Compliance

[For compliance documentation, visit the product page on TE.com>](#)

EU RoHS Directive 2011/65/EU	Compliant
EU ELV Directive 2000/53/EC	Compliant
China RoHS 2 Directive MIIT Order No 32, 2016	No Restricted Materials Above Threshold
EU REACH Regulation (EC) No. 1907/2006	Current ECHA Candidate List: JUNE 2022 (224) Candidate List Declared Against: JAN 2022 (223) SVHC > Threshold: Not Yet Reviewed
Halogen Content	Low Halogen - Br, Cl, F, I < 900 ppm per homogenous material. Also BFR/CFR/PVC Free
Solder Process Capability	Not applicable for solder process capability

Product Compliance Disclaimer

This information is provided based on reasonable inquiry of our suppliers and represents our current actual knowledge based on the information they provided. This information is subject to change. The part numbers that TE has identified as EU RoHS compliant have a maximum concentration of 0.1% by weight in homogenous materials for lead, hexavalent chromium, mercury, PBB, PBDE, DBP, BBP, DEHP, DIBP, and 0.01% for cadmium, or qualify for an exemption to these limits as defined in the Annexes of Directive 2011/65/EU (RoHS2). Finished electrical and electronic equipment products will be CE marked as required by Directive 2011/65/EU. Components may not be CE marked. Additionally, the part numbers that TE has identified as EU ELV compliant have a maximum concentration of 0.1% by weight in homogenous materials for lead, hexavalent chromium, and mercury, and 0.01% for cadmium, or qualify for an exemption to these limits as defined in the Annexes of Directive 2000/53/EC (ELV). Regarding the REACH Regulation, the information TE provides on SVHC in articles for this part number is based on the latest European Chemicals Agency (ECHA) 'Guidance on requirements for substances in articles' posted at this URL: <https://echa.europa.eu/guidance-documents/guidance-on-reach>

Compatible Parts



Also in the Series | **FASTON 250**

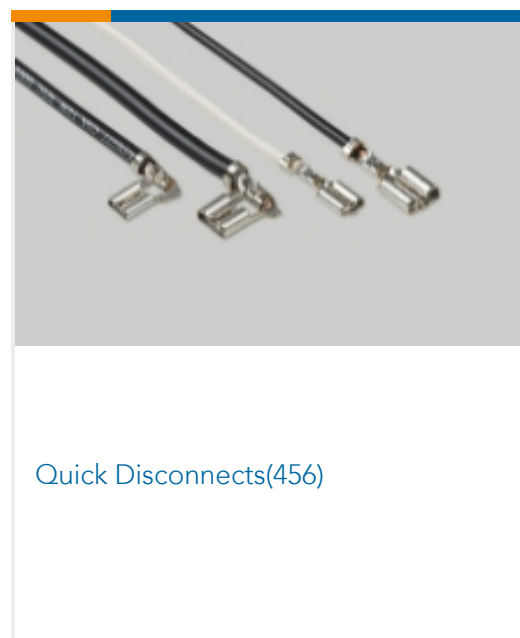
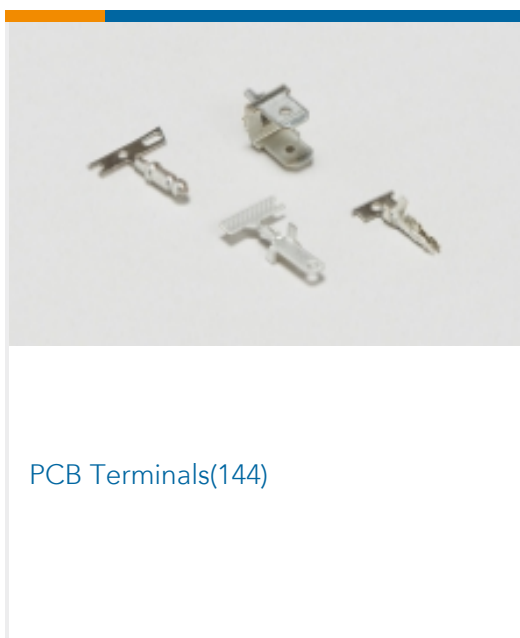
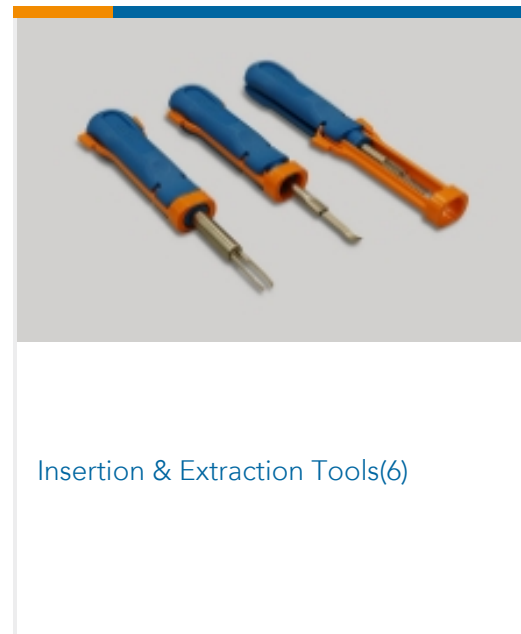
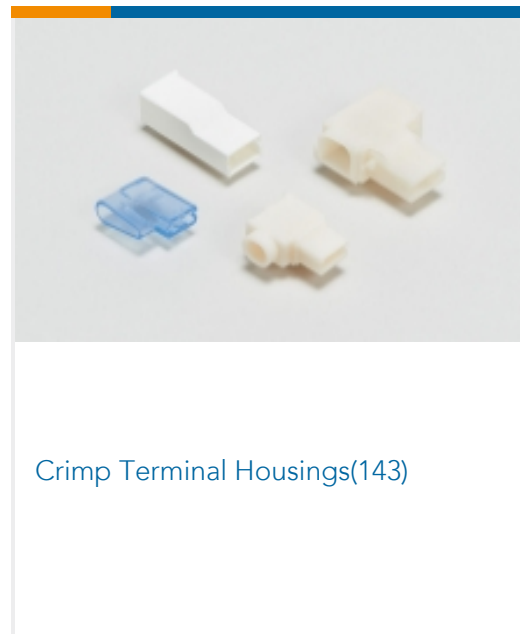
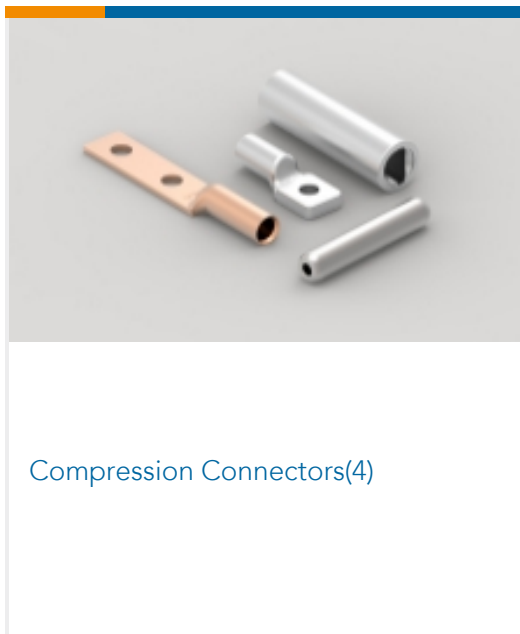

Customers Also Bought

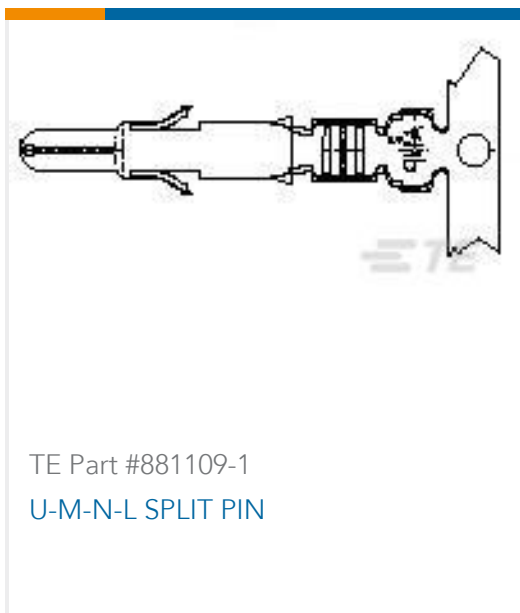



Documents

Product Drawings

[FASTON 250 TAB 18-14 0.394 X 13.20 PTPBR](#)

English

CAD Files

[3D PDF](#)

3D

Customer View Model

[ENG_CVM_CVM_626378-2_H1.2d_dxf.zip](#)

English

Customer View Model

[ENG_CVM_CVM_626378-2_H1.3d_igs.zip](#)

English

Customer View Model

[ENG_CVM_CVM_626378-2_H1.3d_stp.zip](#)

English

By downloading the CAD file I accept and agree to the [Terms and Conditions](#) of use.

Product Specifications

[Product Specification](#)

English