



MTA 100

TE Internal #: 644042-5

Standard Rectangular Connectors, Connector Assembly, Receptacle, Mating Alignment, Polarization Mating Alignment Type, Mating Retention, MTA 100

[View on TE.com >](#)

Connectors > Rectangular Connectors > Standard Rectangular Connectors >

Nylon Gold Plated Receptacle: 2.54mm, With Mating Alignment, MTA 100

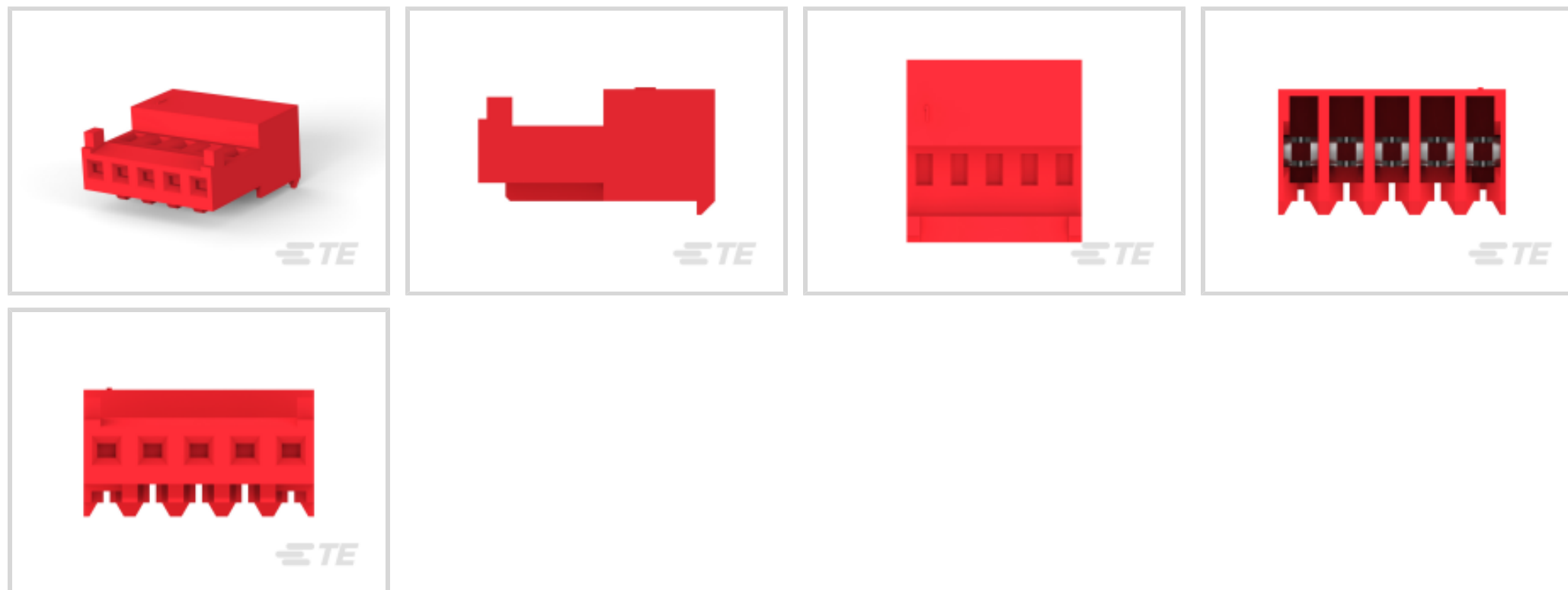

Connector Product Type: **Connector Assembly**

Connector & Housing Type: **Receptacle**

Mating Alignment: **With**

Mating Alignment Type: **Polarization**

Mating Retention: **With**

[All Nylon Gold Plated Receptacle: 2.54mm, With Mating Alignment, MTA 100 \(244\)](#)

## Features

### Product Type Features

Product Style	Assembly
Shape	Rectangular
Wire/Cable Type	Stranded
Connector Type	Connector Assembly
Housing Type	Receptacle
Connector Product Type	Connector Assembly
Connector & Housing Type	Receptacle
Connector System	Wire-to-Board
Insertion Force Type	Normal
Sealable	No
Connector & Contact Terminates To	Wire & Cable

### Configuration Features



Number of Cavities	5
Number of Positions	5
Number of Rows	1
Panel Gasket	Without

#### Electrical Characteristics

Operating Voltage	250 VAC
-------------------	---------

#### Contact Features

Contact Layout	In-line
Contact Type	Female
Wire Contact Termination Area Plating Material	Tin
Contact Underplating Material	Nickel
Contact Mating Area Plating Material	Gold, Gold Flash over Palladium Nickel
Contact Retention Within Housing	With
Contact Current Rating (Max)	5 A

#### Termination Features

Termination Method to Wire & Cable	Insulation Displacement (IDC)
------------------------------------	-------------------------------

#### Mechanical Attachment

Panel Mount	No
Contact Retention Type Within Housing	Locking Lance
Panel Mount Feature	Without
Mating Alignment	With
Mating Alignment Type	Polarization
Mating Retention	With
Mating Retention Type	Locking Ramp
Connector Mounting Type	Cable Mount (Free-Hanging)

#### Housing Features

Housing Color	Red
Housing Material	Nylon 6/6
Centerline (Pitch)	2.54 mm[.1 in]

#### Dimensions

Width	13.21 mm[.52 in]
Height	6.99 mm[.275 in]



Length	12.7 mm[.5 in]
--------	----------------

Wire Size	.3 – .4 mm <sup>2</sup>
-----------	-------------------------

### Usage Conditions

Operating Temperature Range	-55 – 105 °C[-67 – 221 °F]
-----------------------------	----------------------------

### Operation/Application

Shielded	No
----------	----

Circuit Application	Signal
---------------------	--------

### Industry Standards

CSA Rating	Certified
------------	-----------

Agency/Standard	CSA, UL
-----------------	---------

UL Rating	Recognized
-----------	------------

CSA File Number	LR 7189
-----------------	---------

UL File Number	E28476
----------------	--------

UL Flammability Rating	UL 94V-2
------------------------	----------

### Packaging Features

Packaging Quantity	500
--------------------	-----

Packaging Method	Bag/Box
------------------	---------

### Product Compliance

[For compliance documentation, visit the product page on TE.com>](#)

EU RoHS Directive 2011/65/EU	Compliant
------------------------------	-----------

EU ELV Directive 2000/53/EC	Compliant
-----------------------------	-----------

China RoHS 2 Directive MIIT Order No 32, 2016	No Restricted Materials Above Threshold
---	---

EU REACH Regulation (EC) No. 1907/2006	Current ECHA Candidate List: JUNE 2022 (224) Candidate List Declared Against: JAN 2022 (223) SVHC > Threshold: Not Yet Reviewed
--	--

Halogen Content	Low Halogen - Br, Cl, F, I < 900 ppm per homogenous material. Also BFR/CFR/PVC Free
-----------------	---

Solder Process Capability	Not applicable for solder process capability
---------------------------	--

Product Compliance Disclaimer

This information is provided based on reasonable inquiry of our suppliers and represents our current actual knowledge based on the information they provided. This information is subject to change. The part numbers that TE has identified as EU RoHS compliant have a maximum concentration of 0.1% by weight in homogenous materials for lead, hexavalent chromium, mercury, PBB, PBDE, DBP, BBP, DEHP, DIBP, and 0.01% for cadmium, or qualify for an exemption to these limits as defined in the Annexes of Directive 2011/65/EU (RoHS2). Finished electrical and electronic equipment products will be CE marked as required by Directive 2011/65/EU. Components may not be CE marked. Additionally, the part numbers that TE has identified as EU ELV compliant have a maximum concentration of 0.1% by weight in homogenous materials for lead, hexavalent chromium, and mercury, and 0.01% for cadmium, or qualify for an exemption to these limits as defined in the Annexes of Directive 2000/53/EC (ELV). Regarding the REACH Regulation, the information TE provides on SVHC in articles for this part number is based on the latest European Chemicals Agency (ECHA) 'Guidance on requirements for substances in articles' posted at this URL: <https://echa.europa.eu/guidance-documents/guidance-on-reach>

## Compatible Parts



TE Part # CAT-104MTA-PRUSH  
Polyester Right Angle PCB Header:  
2.54mm, Unshrouded, MTA 100



TE Part # CAT-104MTA-PLSCC  
Polyester PCB Connector Covers: 2.54  
mm, MTA 100



TE Part # CAT-104MTA-PVUNH  
Polyester Vertical PCB Header: 2.54  
mm, Unshrouded, No Mating  
Alignment



TE Part # CAT-104MTA-NYLCC  
Nylon PCB Connector Covers: 2.54  
mm, MTA 100



TE Part # CAT-104MTA-PVUMH  
Polyester Vertical PCB Header: 2.54  
mm, With Mating Alignment,  
Unshrouded



TE Part # 3-641214-5  
05P MTA100 HDR ASSY PO/RA LF



TE Part # 58074-1  
MTA 50/100/156 MANUAL TOOL  
FRAME



TE Part # CAT-104MTA-PVSHH  
Polyester Vertical PCB Header: 2.54  
mm, Shrouded, MTA 100



TE Part # CAT-104MTA-PRSMH  
Polyester Right Angle PCB Header:  
2.54mm, Shrouded, With Mating  
Alignment



TE Part # CAT-104MTA-NVSMH  
Nylon Vertical PCB Header: 2.54mm,  
Surface Mount, MTA 100



TE Part # CAT-104MTA-NGPMP  
Nylon Gold Plated Plug: 2.54mm, With  
Mating Alignment, MTA 100



TE Part # 3-647116-5  
05P MTA100 HDR HT FL 30AU LF



TE Part # 3-647117-5  
05P MTA100 HDR HT FL 30AU LF



TE Part # CAT-104MTA-PVBRH  
Polyester Vertical PCB Header: 2.54  
mm, Breakaway, MTA 100



TE Part # 58246-3  
MTA 100 CRIMP HEAD PRODUCTION  
RBBN CABLE



TE Part # 58579-1  
MTA 100 MANUAL TOOL ASSEMBLY  
DISCRETE



TE Part # 58039-1  
MTA 100 ARBOR FIXTURE DISCRETE  
RBN CABLE



TE Part # 58246-2  
MTA 100 CRIMP HEAD PRODUCTION  
DISCRETE

Also in the Series | **MTA 100**

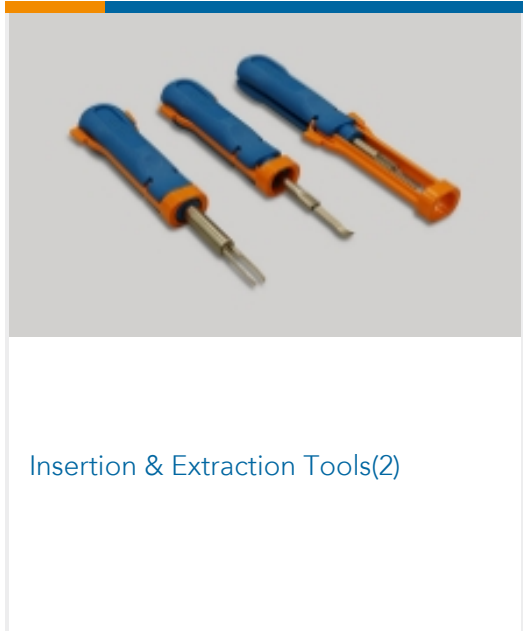

Insertion & Extraction Tools(2)



PCB Connector Covers(107)



PCB Connector Keying(1)



PCB Headers & Receptacles(1182)

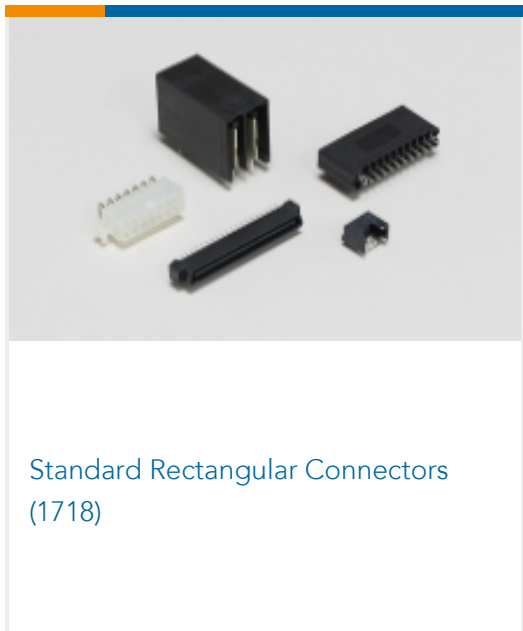

Standard Rectangular Connectors  
(1718)

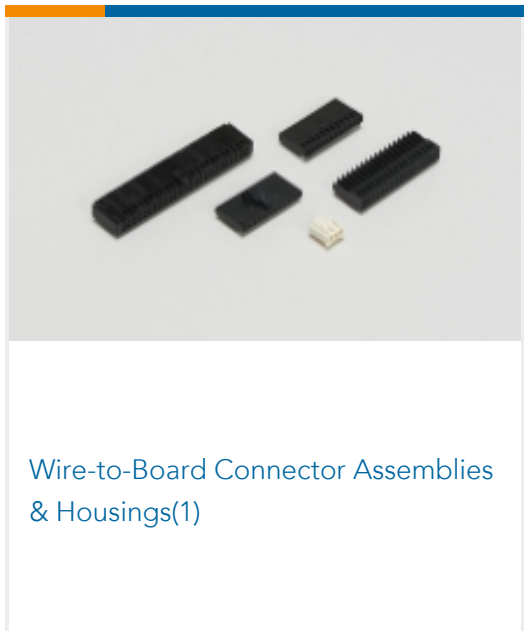

Wire-to-Board Connector Assemblies  
& Housings(1)

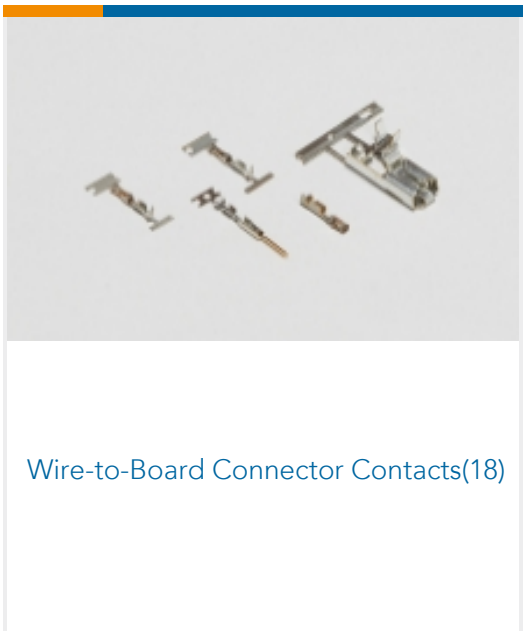

Wire-to-Board Connector Contacts(18)

Customers Also Bought



TE Part #3-641191-4  
04P MTA100 CONN ASSY WHT LF

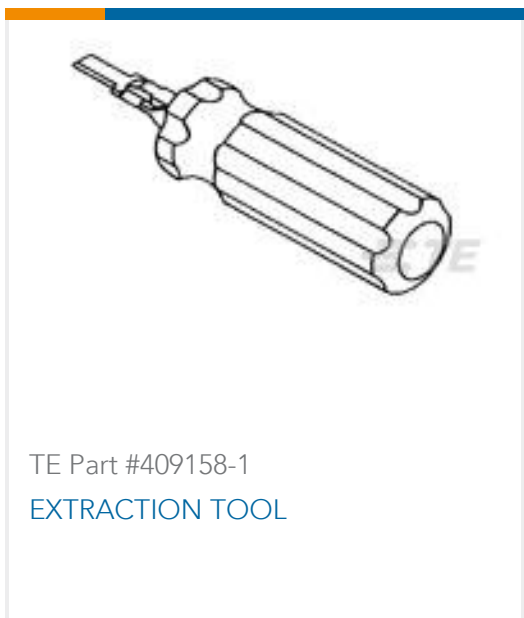

TE Part #409158-1  
EXTRACTION TOOL



TE Part #205089-1  
HD 20 PIN CONTACT



TE Part #521125-1  
PL 187 HOUSING TAB 0.81 NYLON 6/6



TE Part #63498-1  
PL 187 TERMINAL REC 20-16 AWG  
TPBR



TE Part #1-747150-4  
09 RCPT SP/FMS SCRLK

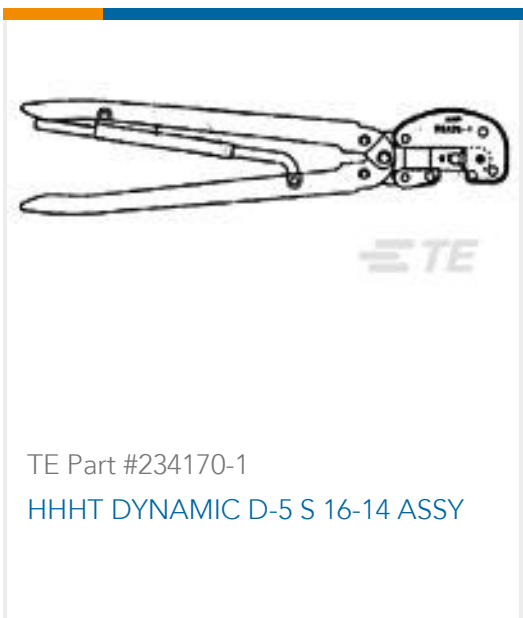

TE Part #234170-1  
HHHT DYNAMIC D-5 S 16-14 ASSY



TE Part #4-641150-0  
10P MTA156 ASSY 22AWG RED LF



## Documents

### Product Drawings

05P MTA100 CONN ASSY 30AU

English

### CAD Files

3D PDF

3D

Customer View Model

[ENG\\_CVM\\_CVM\\_644042-5\\_J\\_c-644042-5-j.2d\\_dxf.zip](#)

English

Customer View Model

[ENG\\_CVM\\_CVM\\_644042-5\\_J\\_c-644042-5-j.3d\\_igs.zip](#)

English

Customer View Model

[ENG\\_CVM\\_CVM\\_644042-5\\_J\\_c-644042-5-j.3d\\_stp.zip](#)

English

By downloading the CAD file I accept and agree to the [Terms and Conditions](#) of use.

### Datasheets & Catalog Pages

MTA, CST-100 II, SL-156 and AMP Economy Power (EP) Connectors

English