

650074-000 ✓ ACTIVE

RAYCHEM

TE Internal #: 650074-000

Splices, 26 – 20 AWG Wire Size, .15 – .61 mm² Wire Size, Sealable, Splice Kit, .048 in [1.2 mm] Barrel Inside Diameter, 304 – 1216 CMA Wire Size

[View on TE.com >](#)



Terminals & Splices > Splices

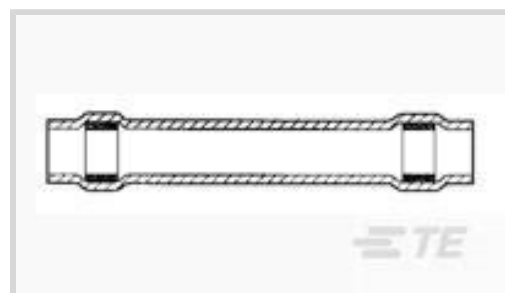

Wire Size: .15 – .61 mm²

Sealable: **Yes**

Splice Features: **Splice Kit**

Barrel Inside Diameter: 1.2 mm [.048 in]

Features

Product Type Features

Splice Accessory Type	Splice
Sealable	Yes
Serrated	No
Wire Insulation Support Retention Type	Non-Insulation Support

Configuration Features

Number of Serrations	0
Compatible With Wire & Cable Type	Discrete Wire

Body Features

Weight per Piece	.68 g
Splice Features	Splice Kit
Primary Product Material	Copper Alloy

Contact Features

Barrel Type	Closed
-------------	--------

Dimensions

Wire Size	304 – 1216 CMA
Barrel Inside Diameter	1.2 mm[.048 in]
Overall Product Length	29.21 mm[1.15 in]

Usage Conditions

--	--



Insulation Option	Fully Insulated
Operating Temperature Range	-55 – 150 °C[-67 – 302 °F]

Operation/Application

Heavy Duty	No
------------	----

Industry Standards

Government Qualified Splice	Yes
-----------------------------	-----

Packaging Features

Packaging Quantity	100
Packaging Method	Bag/Box

Product Compliance

[For compliance documentation, visit the product page on TE.com>](#)

EU RoHS Directive 2011/65/EU	Compliant
EU ELV Directive 2000/53/EC	Compliant
China RoHS 2 Directive MIIT Order No 32, 2016	No Restricted Materials Above Threshold
EU REACH Regulation (EC) No. 1907/2006	Current ECHA Candidate List: JUNE 2022 (224) Candidate List Declared Against: JUL 2021 (219) SVHC > Threshold: Not Yet Reviewed
Halogen Content	Low Halogen - Br, Cl, F, I < 900 ppm per homogenous material. Also BFR/CFR/PVC Free
Solder Process Capability	Not applicable for solder process capability

Product Compliance Disclaimer

This information is provided based on reasonable inquiry of our suppliers and represents our current actual knowledge based on the information they provided. This information is subject to change. The part numbers that TE has identified as EU RoHS compliant have a maximum concentration of 0.1% by weight in homogenous materials for lead, hexavalent chromium, mercury, PBB, PBDE, DBP, BBP, DEHP, DIBP, and 0.01% for cadmium, or qualify for an exemption to these limits as defined in the Annexes of Directive 2011/65/EU (RoHS2). Finished electrical and electronic equipment products will be CE marked as required by Directive 2011/65/EU. Components may not be CE marked. Additionally, the part numbers that TE has identified as EU ELV compliant have a maximum concentration of 0.1% by weight in homogenous materials for lead, hexavalent chromium, and mercury, and 0.01% for cadmium, or qualify for an exemption to these limits as defined in the Annexes of Directive 2000/53/EC (ELV). Regarding the REACH Regulation, the information TE provides on SVHC in articles for this part number is based on the latest European Chemicals Agency (ECHA) 'Guidance on requirements for substances in articles' posted at this URL: <https://echa.europa.eu/guidance-documents/guidance-on-reach>

Compatible Parts

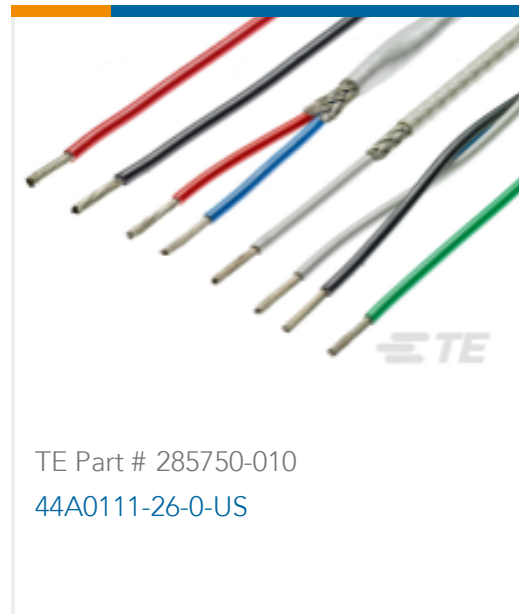
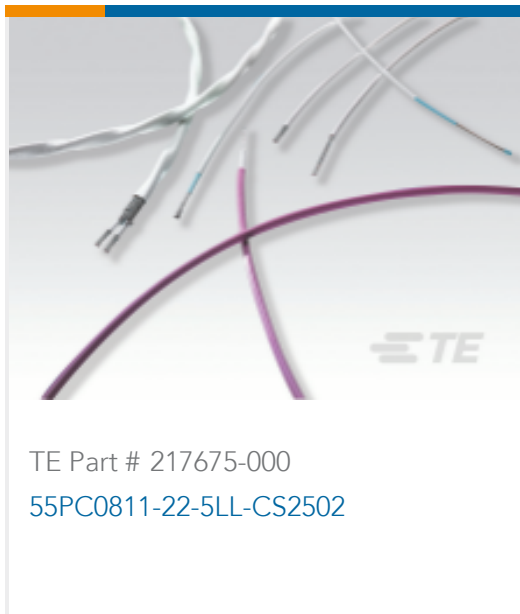
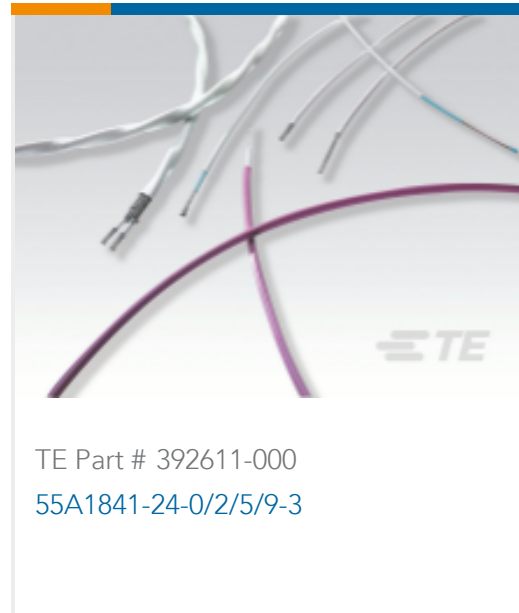
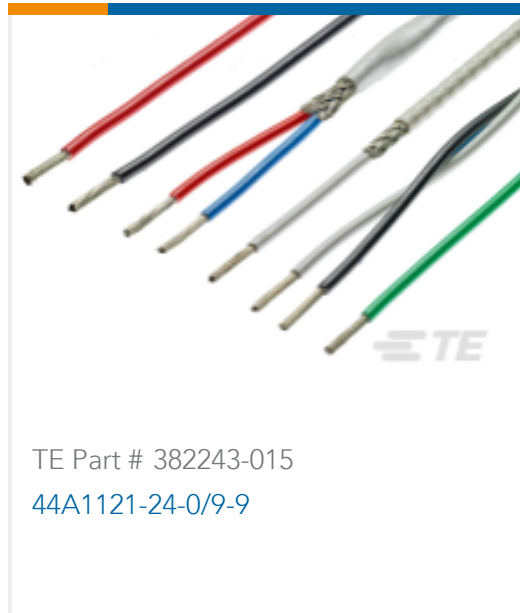
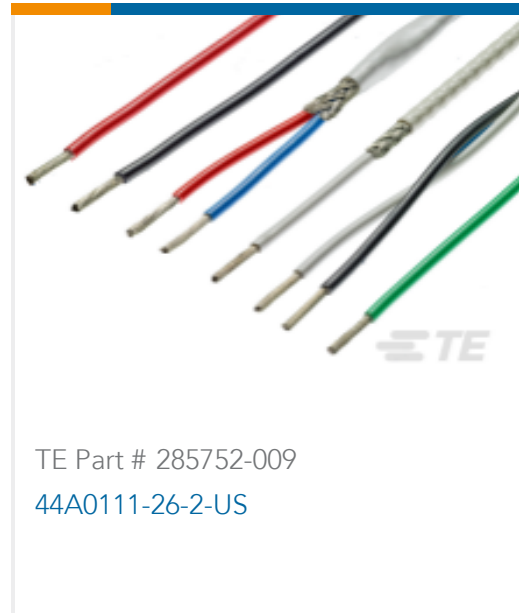

Customers Also Bought

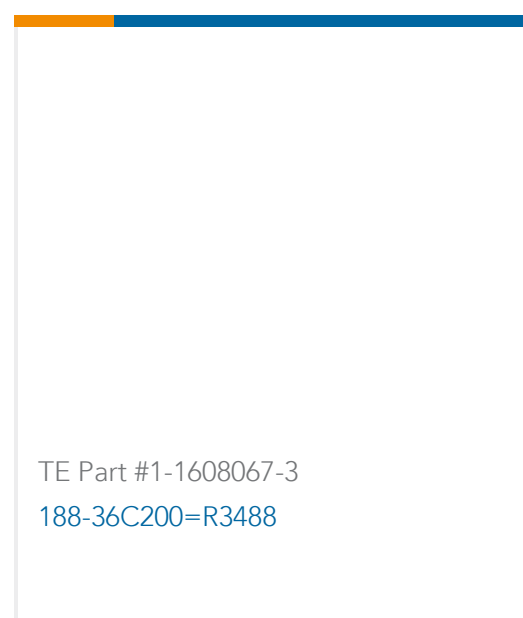
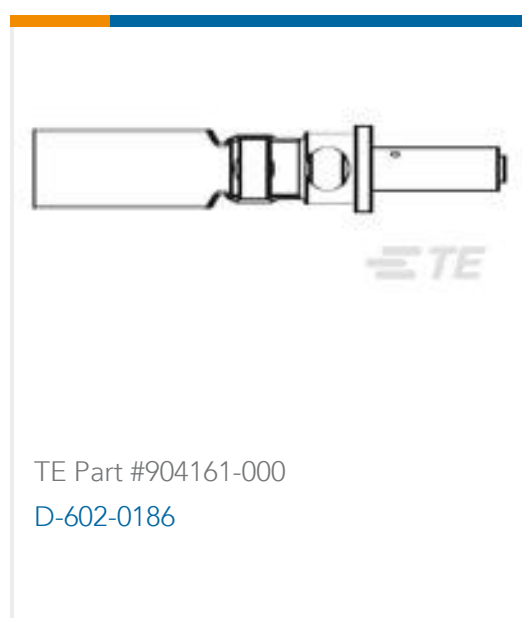

Documents

CAD Files

3D PDF

3D

Customer View Model

[ENG_CVM_CVM_650074-000_O.2d_dxf.zip](#)

English

Customer View Model

[ENG_CVM_CVM_650074-000_O.3d_igs.zip](#)

English

Customer View Model

[ENG_CVM_CVM_650074-000_O.3d_stp.zip](#)

English

By downloading the CAD file I accept and agree to the [Terms and Conditions](#) of use.

Datasheets & Catalog Pages

[1654025_Sec8_D-436](#)

English

[Harness Repair Products Quick Reference Guide](#)

English



[Product Specifications](#)

[Application Specification](#)

English