

60742-1 ✓ ACTIVE

FASTON 187

TE Internal #: 60742-1

TE Internal Description: 187 FASTON REC 18-14 AWG BR

[View on TE.com >](#)

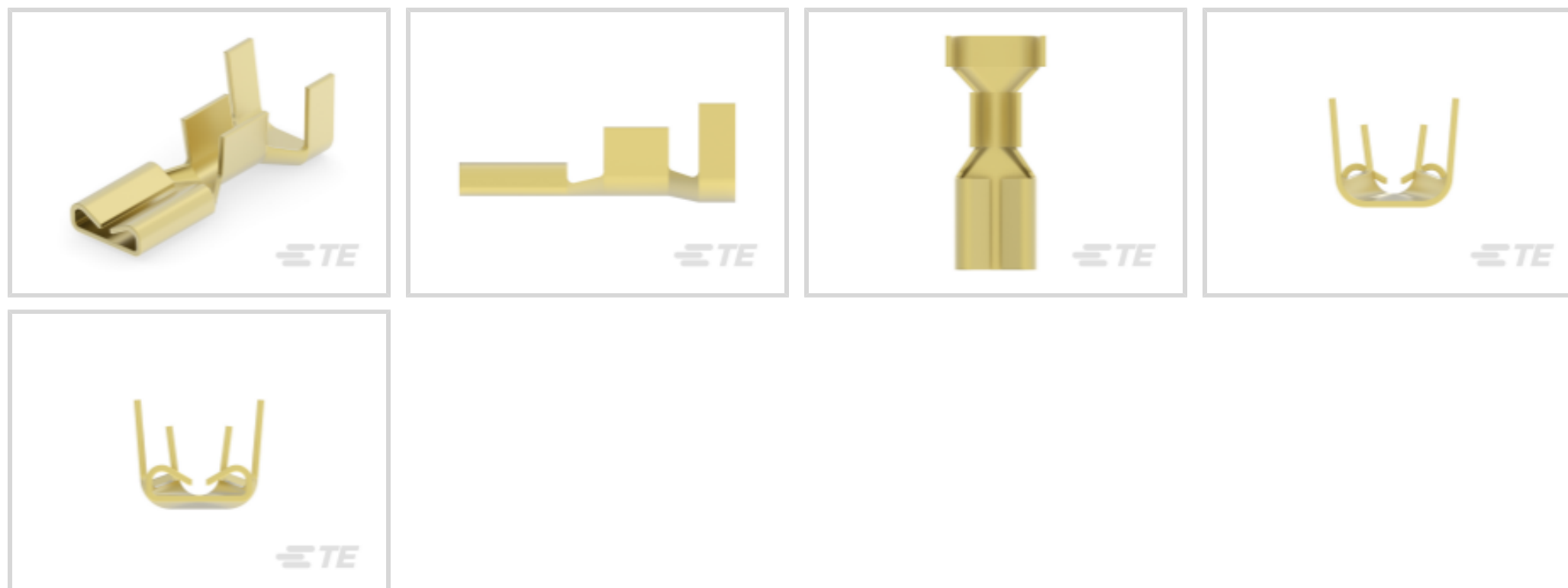

Product Compliance

[For compliance documentation, visit the product page on TE.com>](#)

EU RoHS Directive 2011/65/EU	Compliant
EU ELV Directive 2000/53/EC	Compliant
China RoHS 2 Directive MIIT Order No 32, 2016	No Restricted Materials Above Threshold
EU REACH Regulation (EC) No. 1907/2006	Current ECHA Candidate List: JUNE 2022 (224) Candidate List Declared Against: JAN 2022 (223) SVHC > Threshold: Not Yet Reviewed
Halogen Content	Low Halogen - Br, Cl, F, I < 900 ppm per homogenous material. Also BFR/CFR/PVC Free
Solder Process Capability	Not applicable for solder process capability

Product Compliance Disclaimer

This information is provided based on reasonable inquiry of our suppliers and represents our current actual knowledge based on the information they provided. This information is subject to change. The part numbers that TE has identified as EU RoHS compliant have a maximum concentration of 0.1% by weight in homogenous materials for lead, hexavalent chromium, mercury, PBB, PBDE, DBP, BBP, DEHP, DIBP, and 0.01% for cadmium, or qualify for an exemption to these limits as defined in the Annexes of Directive 2011/65/EU (RoHS2). Finished electrical and electronic equipment products will be CE marked as required by Directive 2011/65/EU. Components may not be CE marked. Additionally, the part numbers that TE has identified as EU ELV compliant have a maximum concentration of 0.1% by weight in homogenous materials for lead, hexavalent chromium, and mercury, and 0.01% for cadmium, or qualify for an exemption to these limits as defined in the Annexes of Directive 2000/53/EC (ELV). Regarding the REACH Regulation, the information TE provides on SVHC in articles for this part number is based on the latest European Chemicals Agency (ECHA) 'Guidance on requirements for substances in articles' posted at this URL: <https://echa.europa.eu/guidance-documents/guidance-on-reach>

Compatible Parts



TE Part # 2150312-1
OCEAN_2.0_Applicator-E-110F250F



TE Part # 2-2150312-1
OCEAN_2.0_Applicator-E-110F250F



TE Part # 2-2150312-2
OCEAN_2.0_Applicator-E-110F250F



TE Part # 2150312-2
OCEAN_2.0_Applicator-E-110F250F



TE Part # 7-2150312-1
OCEAN_2.0_Applicator-E-110F250F



TE Part # 7-2150312-2
OCEAN_2.0_Applicator-E-110F250F



TE Part # 7-2150312-7
OCEAN_2.0_SPARE_PART_KIT-110F250F

Also in the Series | FASTON 187

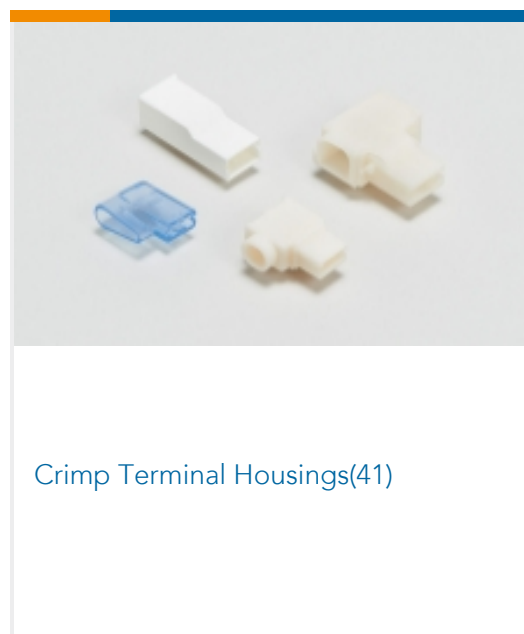

Crimp Terminal Housings(41)

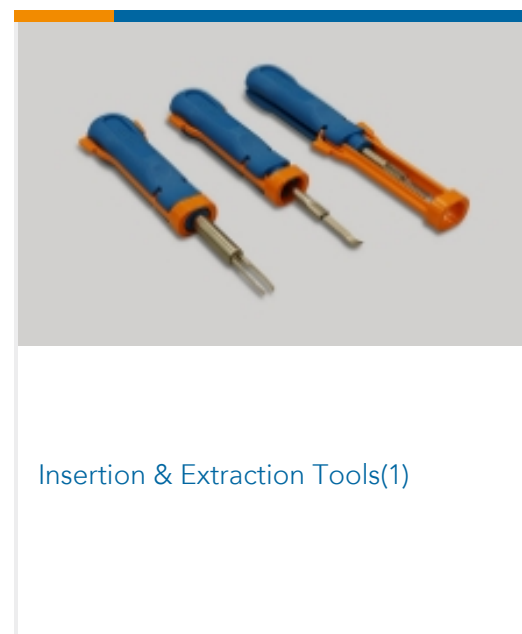

Insertion & Extraction Tools(1)

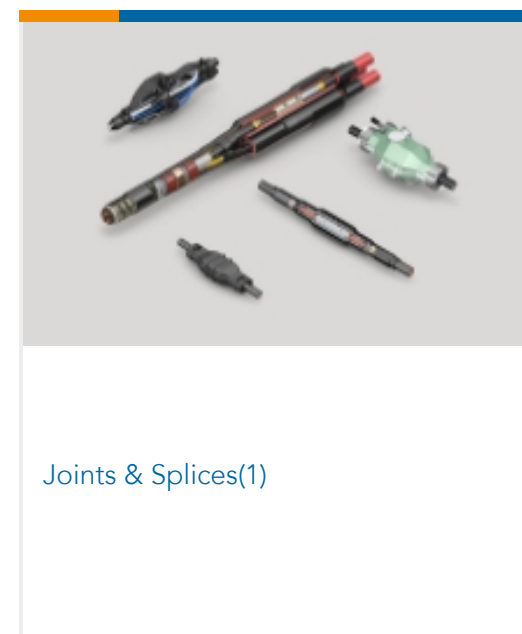

Joints & Splices(1)

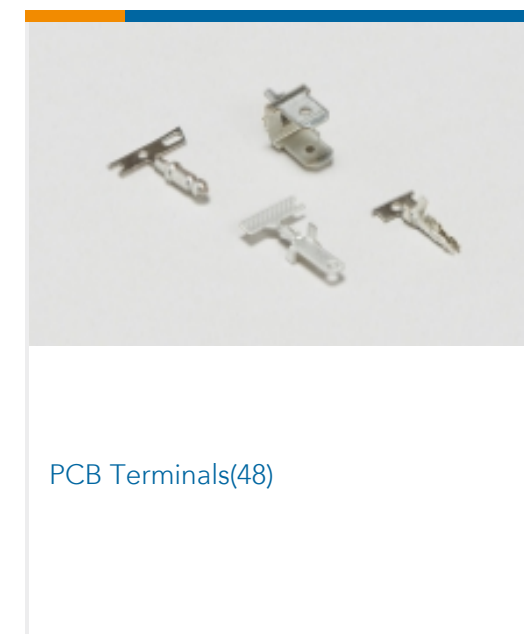

PCB Terminals(48)

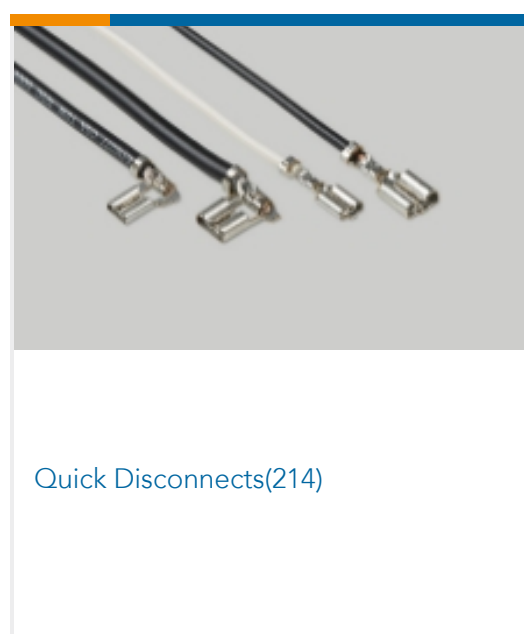

Quick Disconnects(214)



Splices(1)

Customers Also Bought



TE Part #2106136-2
Assembly, Receptacle, 2-Position



TE Part #2106135-2
Assembly, Free Hanging Plug, SLC, 2 pos



TE Part #60775-1
SPADE TERMINAL 18-14 AWG BR



TE Part #42742-1
250 FASTON FLAG REC 18-12 AWG BR



TE Part #40888
RING TERMINAL 20-16 AWG TPBR



TE Part #1-2106123-1
CONTACT,Recept, SLC, Tin Plated,
On Stri

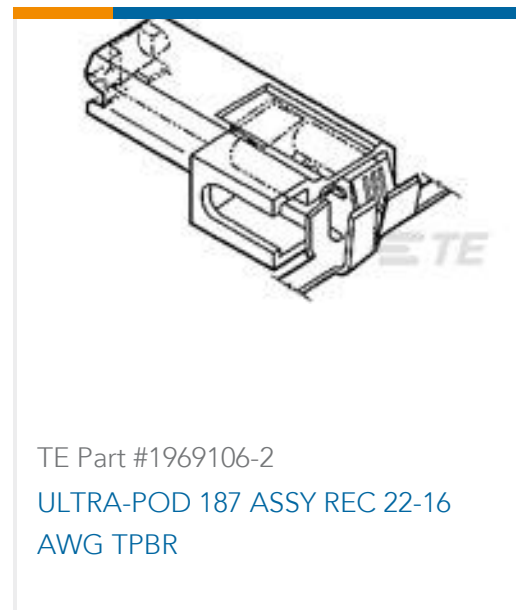

TE Part #1969106-2
ULTRA-POD 187 ASSY REC 22-16
AWG TPBR

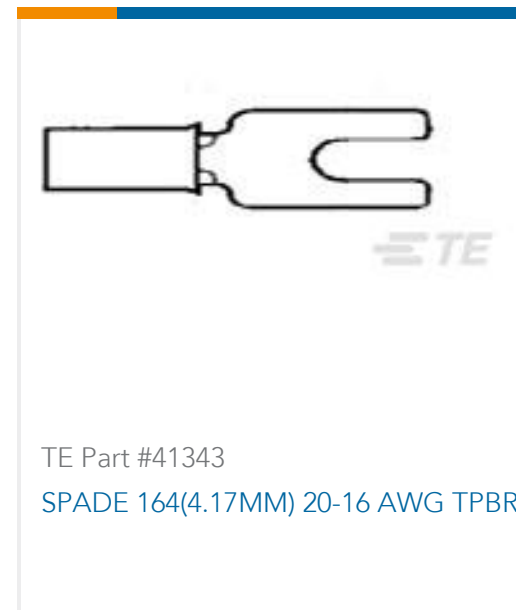

TE Part #41343
SPADE 164(4.17MM) 20-16 AWG TPBR



TE Part #2154852-1
SlimSeal Assy, Receptacle, 1-Position

Documents

Product Drawings

[187 FASTON REC 18-14 AWG BR](#)

English

CAD Files

Customer View Model

[ENG_CVM_CVM_60742-1_AD.2d_dxf.zip](#)

English

3D PDF

3D

Customer View Model

[ENG_CVM_CVM_60742-1_AD.3d_igs.zip](#)

English

Customer View Model

[ENG_CVM_CVM_60742-1_AD.3d_stp.zip](#)

English

By downloading the CAD file I accept and agree to the [Terms and Conditions](#) of use.

Datasheets & Catalog Pages

[82004 FASTON Terminals \(Insulated and Uninsulated\) Catalog - FASTON Receptacles Section](#)

English

Product Specifications

[Application Specification](#)

English

Product Environmental Compliance

[TE Material Declaration](#)



English

Instruction Sheets

Instruction Sheet (U.S.)

English

Application and Maintenance for Hand Crimping Tool

English

Agency Approvals

CSA Certificate

English

CSA Certificate

English