



MTA 156

TE Internal #: 641217-3

Standard Rectangular Connectors, Connector Assembly, Receptacle, Mating Retention, Insulation Displacement (IDC), Wire-to-Board, MTA 156

[View on TE.com >](#)

Connectors > Rectangular Connectors > Standard Rectangular Connectors

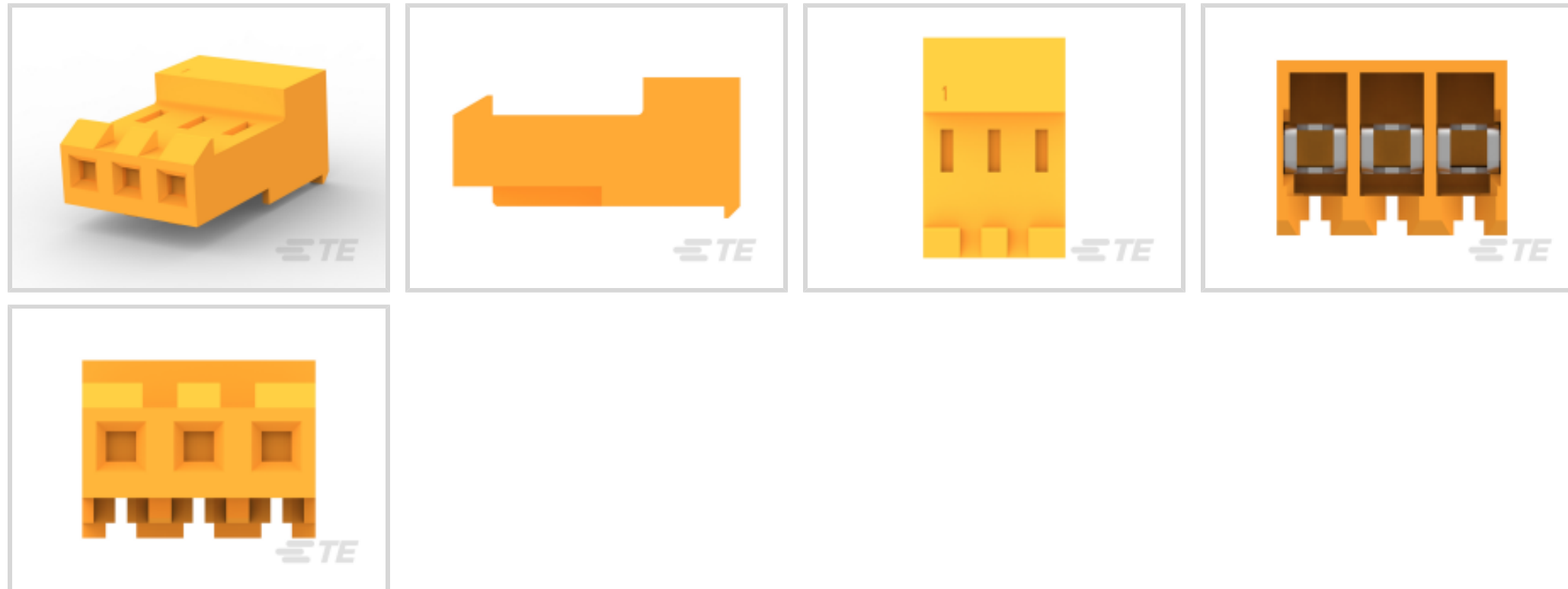

Connector Product Type: **Connector Assembly**

Connector & Housing Type: **Receptacle**

Mating Alignment: **Without**

Mating Retention: **With**

Mating Retention Type: **Locking Ramp**

Features

Product Type Features

Product Style	Assembly
Shape	Rectangular
Wire/Cable Type	Stranded
Connector Type	Connector Assembly
Housing Type	Receptacle
Connector Product Type	Connector Assembly
Connector & Housing Type	Receptacle
Connector System	Wire-to-Board
Insertion Force Type	Normal
Sealable	No
Connector & Contact Terminates To	Wire & Cable

Configuration Features

Number of Cavities	3
Number of Positions	3



Number of Rows	1
----------------	---

Panel Gasket	Without
--------------	---------

Electrical Characteristics

Operating Voltage	600 VAC
-------------------	---------

Contact Features

Contact Layout	In-line
----------------	---------

Contact Type	Female
--------------	--------

Wire Contact Termination Area Plating Material	Tin
--	-----

Contact Underplating Material	Nickel
-------------------------------	--------

Contact Mating Area Plating Material	Gold, Gold Flash over Palladium Nickel
--------------------------------------	--

Contact Retention Within Housing	With
----------------------------------	------

Contact Current Rating (Max)	7 A
------------------------------	-----

Termination Features

Termination Method to Wire & Cable	Insulation Displacement (IDC)
------------------------------------	-------------------------------

Mechanical Attachment

Panel Mount	No
-------------	----

Contact Retention Type Within Housing	Locking Lance
---------------------------------------	---------------

Panel Mount Feature	Without
---------------------	---------

Mating Alignment	Without
------------------	---------

Mating Retention	With
------------------	------

Mating Retention Type	Locking Ramp
-----------------------	--------------

Connector Mounting Type	Cable Mount (Free-Hanging)
-------------------------	----------------------------

Housing Features

Housing Color	Orange
---------------	--------

Housing Material	Nylon 6/6
------------------	-----------

Centerline (Pitch)	3.96 mm[.156 in]
--------------------	------------------

Dimensions

Width	9.02 mm[.355 in]
-------	------------------

Height	18.42 mm[.725 in]
--------	-------------------

Length	11.89 mm[.468 in]
--------	-------------------

Wire Size	.8 – .9 mm ²
-----------	-------------------------

Usage Conditions



Operating Temperature Range	-55 – 105 °C[-67 – 221 °F]
-----------------------------	----------------------------

Operation/Application

Shielded	No
Circuit Application	Power

Industry Standards

CSA Rating	Certified
Agency/Standard	CSA, UL
UL Rating	Recognized
CSA File Number	LR 7189
UL File Number	E28476
UL Flammability Rating	UL 94V-2

Packaging Features

Packaging Quantity	500
Packaging Method	Bag/Box

Product Compliance

[For compliance documentation, visit the product page on TE.com>](#)

EU RoHS Directive 2011/65/EU	Compliant
EU ELV Directive 2000/53/EC	Compliant
China RoHS 2 Directive MIIT Order No 32, 2016	No Restricted Materials Above Threshold
EU REACH Regulation (EC) No. 1907/2006	Current ECHA Candidate List: JUNE 2022 (224) Candidate List Declared Against: JUNE 2022 (224) Does not contain REACH SVHC
Halogen Content	Low Halogen - Br, Cl, F, I < 900 ppm per homogenous material. Also BFR/CFR/PVC Free
Solder Process Capability	Not applicable for solder process capability

Product Compliance Disclaimer

This information is provided based on reasonable inquiry of our suppliers and represents our current actual knowledge based on the information they provided. This information is subject to change. The part numbers that TE has identified as EU RoHS compliant have a maximum concentration of 0.1% by weight in homogenous materials for lead, hexavalent chromium, mercury, PBB, PBDE, DBP, BBP, DEHP, DIBP, and 0.01% for cadmium, or qualify for an exemption to these limits as defined in the Annexes of Directive 2011/65/EU (RoHS2). Finished electrical and electronic equipment products will be CE marked as required by Directive 2011/65/EU. Components may not be CE marked. Additionally, the part numbers that TE has identified as EU ELV compliant have a maximum concentration of 0.1% by weight in homogenous materials for lead, hexavalent chromium, and mercury, and 0.01% for cadmium, or qualify for an exemption to these limits

as defined in the Annexes of Directive 2000/53/EC (ELV). Regarding the REACH Regulation, the information TE provides on SVHC in articles for this part number is based on the latest European Chemicals Agency (ECHA) 'Guidance on requirements for substances in articles' posted at this URL: <https://echa.europa.eu/guidance-documents/guidance-on-reach>

Compatible Parts



TE Part # 58247-1
MTA 156 CRIMP HEAD REPAIR
DISCRETE



TE Part # 58074-1
MTA 50/100/156 MANUAL TOOL
FRAME



TE Part # 3-641209-3
03P MTA156 HDR ASSY FL ST LF



TE Part # 643071-3
03P MTA156 FD-THRU COVER



TE Part # 640551-3
03P MTA156 COVER



TE Part # 641937-2
03P MTA156 HDR ASSY SQ W/O#3



TE Part # 641937-1
03P MTA156 HDR ASSY STR W/O#2



TE Part # 643067-3
03P MTA156 MOLDED COVER



TE Part # 3-644812-3
03P MTA156 PSTD CONN 18AWG LF



TE Part # 3-644807-3
03P MTA156 PSTD CONN 18AWG LF



TE Part # 59804-1
MAINTENANCE TOOL

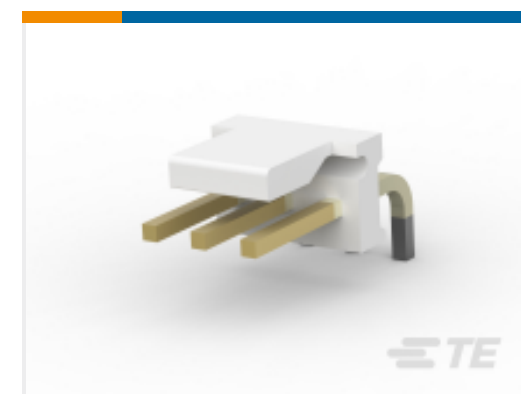

TE Part # 3-641210-3
03P MTA156 HDR FLRA FB 30AU LF

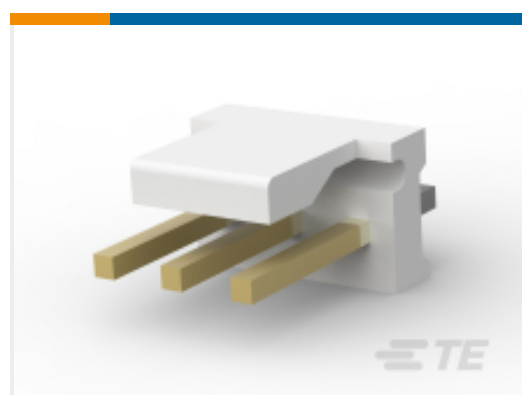

TE Part # 3-641208-3
03P MTA156 HDR ASSY FL ST LF



TE Part # 640643-3
03P MTA156 COVER F/T



TE Part # 3-644759-3
03P MTA156 HDR ASSY STR LF

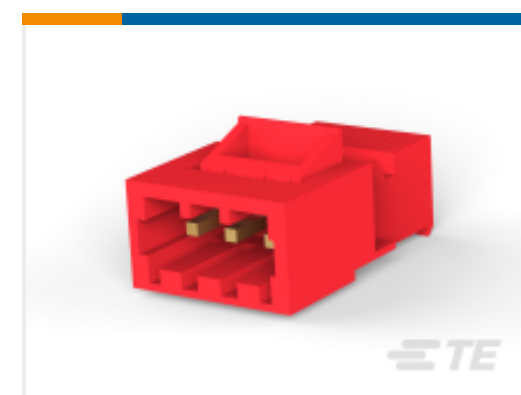

TE Part # 3-644809-3
03P MTA156 PSTD CONN 22AWG LF



TE Part # 58247-3
MTA 156 CRIMP HEAD PRODUCTION
RBBN CABLE



TE Part # 3-641202-3
03P MTA156 HDR ASSY PL 30AU LF



TE Part # 3-641203-3
03P MTA156 HDR ASSY PL 30AU LF



TE Part # 3-641204-3
03P MTA156 HDR ASSY PL 30AU LF

Also in the Series | MTA 156



Insertion & Extraction Tools(1)



PCB Connector Covers(92)



PCB Connector Keying(2)

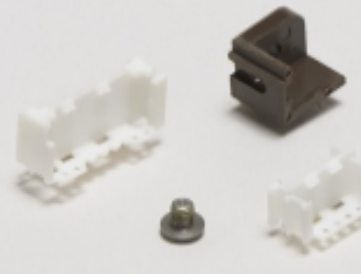

PCB Connector Mounting(1)



PCB Headers & Receptacles(729)



Power Contacts(3)



Rectangular Caps & Covers(1)



Rectangular Power Connectors(749)



Standard Rectangular Connectors
(1309)



Wire-to-Board Connector Contacts(12)

Customers Also Bought



TE Part #4-647016-1
Nylon Gold Plated Plug: 2.54mm, With
Mating Alignment, MTA 100

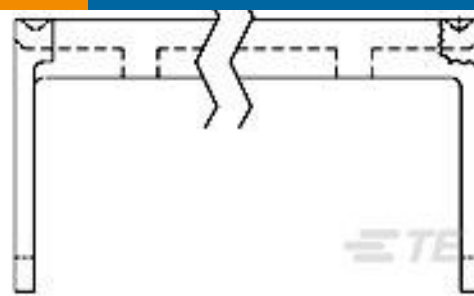

TE Part #7-1437023-1
622-1431=FSKT IDC S 14 SR

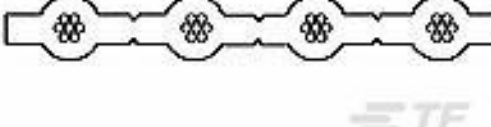

TE Part #57744-5
Madison Spec 100-7244 Rev. 2



TE Part #3-641522-9
09P MTA156 POST CON ASSY ORNG



Documents

Product Drawings

[03P MTA156 CONN ASSY 18AWG ORA](#)

English

CAD Files

[3D PDF](#)

3D

Customer View Model

[ENG_CVM_CVM_641217-3_W.2d_dxf.zip](#)

English

Customer View Model

[ENG_CVM_CVM_641217-3_W.3d_igs.zip](#)

English

Customer View Model

[ENG_CVM_CVM_641217-3_W.3d_stp.zip](#)

English

By downloading the CAD file I accept and agree to the [Terms and Conditions](#) of use.

Datasheets & Catalog Pages

[MTA, CST-100 II, SL-156 and AMP Economy Power \(EP\) Connectors](#)

English

Product Specifications

[Application Specification](#)

Japanese

[Application Specification](#)

English

[MTA 156 Ribbon Cable Connector Assemblies \(English And Spanish\)](#)

English

[MTA 156 Ribbon Cable Connector Assemblies \(English And Spanish\)](#)

Japanese

Agency Approvals

[Agency Approval Document](#)

English

