



SL-156

TE Internal #: 647401-2

Housing, Receptacle, Wire-to-Board, 2 Position, 3.96 mm [.156 in]  
Centerline, Crimp, 1 Row, Natural, Mating Retention, Wire & Cable,  
SL-156

[View on TE.com >](#)

Connectors > PCB Connectors > Wire-to-Board Connectors > Wire-to-Board Connector Assemblies & Housings >

3.96mm Wire-to-board housing: receptacle, with mating alignment, SL 156



Connector Product Type: **Housing**

Connector & Housing Type: **Receptacle**

Connector System: **Wire-to-Board**

Number of Positions: **2**

Centerline (Pitch): **3.96 mm [.156 in]**

[All 3.96mm Wire-to-board housing: receptacle, with mating alignment, SL 156 \(124\)](#)

## Features

### Product Type Features

Connector Product Type	Housing
Connector & Housing Type	Receptacle
Connector System	Wire-to-Board
Sealable	No
Connector & Contact Terminates To	Wire & Cable

### Configuration Features

Number of Positions	2
Number of Rows	1

### Electrical Characteristics

Operating Voltage	250 VAC
-------------------	---------

### Contact Features

--	--



Contact Layout	Inline
Contact Retention Within Housing	Without
Contact Type	Socket
Contact Current Rating (Max)	6.5 A

### Termination Features

Termination Method to Wire & Cable	Crimp
------------------------------------	-------

### Mechanical Attachment

Strain Relief	Without
PCB Mount Alignment	Without
Panel Mount Feature	Without
PCB Mount Retention	Without
Mating Retention Type	Locking Ramp
Mating Retention	With
Connector Mounting Type	Cable Mount (Free-Hanging)

### Housing Features

Housing Entry Configuration	Left End Open
Housing Material	Nylon - GF
Centerline (Pitch)	3.96 mm [.156 in]
Housing Color	Natural

### Dimensions

	.346 in
Connector Height	6.35 mm
Wire Size	.0509 – .823 mm <sup>2</sup>

### Usage Conditions

Operating Temperature Range	-55 – 105 °C [-67 – 221 °F]
-----------------------------	-----------------------------

### Operation/Application

Circuit Application	Power & Signal
---------------------	----------------

### Industry Standards

CSA Rating	Certified
UL Flammability Rating	UL 94V-0
UL File Number	E28476
UL Rating	Listed



Agency/Standard	CSA, UL
CSA File Number	LR 7189

### Packaging Features

Packaging Quantity	1
Packaging Method	Package

### Other

Comment	Unit Accepts 1.14[.045] Square or Round Post, Accepts Keying Plug 640254-1 and 640255-1
---------	---

### Product Compliance





















[For compliance documentation, visit the product page on TE.com>](#)

EU RoHS Directive 2011/65/EU	Compliant
EU ELV Directive 2000/53/EC	Compliant
China RoHS 2 Directive MIIT Order No 32, 2016	No Restricted Materials Above Threshold
EU REACH Regulation (EC) No. 1907/2006	Current ECHA Candidate List: JUNE 2022 (224) Candidate List Declared Against: JAN 2022 (223) SVHC > Threshold: Not Yet Reviewed
Halogen Content	Low Halogen - Br, Cl, F, I < 900 ppm per homogenous material. Also BFR/CFR/PVC Free
Solder Process Capability	Not applicable for solder process capability

#### Product Compliance Disclaimer

This information is provided based on reasonable inquiry of our suppliers and represents our current actual knowledge based on the information they provided. This information is subject to change. The part numbers that TE has identified as EU RoHS compliant have a maximum concentration of 0.1% by weight in homogenous materials for lead, hexavalent chromium, mercury, PBB, PBDE, DBP, BBP, DEHP, DIBP, and 0.01% for cadmium, or qualify for an exemption to these limits as defined in the Annexes of Directive 2011/65/EU (RoHS2). Finished electrical and electronic equipment products will be CE marked as required by Directive 2011/65/EU. Components may not be CE marked. Additionally, the part numbers that TE has identified as EU ELV compliant have a maximum concentration of 0.1% by weight in homogenous materials for lead, hexavalent chromium, and mercury, and 0.01% for cadmium, or qualify for an exemption to these limits as defined in the Annexes of Directive 2000/53/EC (ELV). Regarding the REACH Regulation, the information TE provides on SVHC in articles for this part number is based on the latest European Chemicals Agency (ECHA) 'Guidance on requirements for substances in articles' posted at this URL: <https://echa.europa.eu/guidance-documents/guidance-on-reach>

### Compatible Parts

 <p>TE Part # 640384-2 02P MTA156 HDR ASSY STR RND SN</p>	 <p>TE Part # 640643-2 02P MTA156 COVER F/T</p>	 <p>TE Part # 3-641208-2 02P MTA156 HDR ASSY FL ST LF</p>	 <p>TE Part # 643067-2 02P MTA156 MOLDED COVER</p>
 <p>TE Part # 640551-2 02P MTA156 COVER</p>	 <p>TE Part # 640389-2 02P MTA156 HDR ASSY SQ R/A F/L</p>	 <p>TE Part # 3-641120-2 02P MTA156 HDR ASSY FL/ST LF</p>	 <p>TE Part # 3-641119-2 02P MTA156 HDR ASSY FL/ST LF</p>
 <p>TE Part # 644753-2 02P MTA156 HDR ASSY RN STR F/L</p>	 <p>TE Part # 640388-2 02P MTA156 HDR ASSY RN STR F/L</p>	 <p>TE Part # 640385-2 02P MTA156 HDR ASSY SQ R/A</p>	 <p>TE Part # 640445-2 02P MTA156 HDR ASSY FL/STR SN</p>
 <p>TE Part # 3-641210-2 02P MTA156 HDR FLRA FB 30AU LF</p>	 <p>TE Part # 640383-2 02P MTA156 HDR ASSY STR SQ SN</p>	 <p>TE Part # 3-644615-2 02P MTA156 POL HDR ASSY LF</p>	 <p>TE Part # 643071-2 02P MTA156 FD-THRU COVER</p>
 <p>TE Part # 644751-2 02P MTA156 HDR ASSY R/A</p>	 <p>TE Part # 3-641121-2 02P MTA156 HDR ASSY FL/RA LF</p>	 <p>TE Part # 3-644611-2 02P MTA156 HDR POL WO PEGS LF</p>	 <p>TE Part # 770894-2 02P SL156 HSG W/THRU BD LATCH</p>

Also in the Series | [SL-156](#)

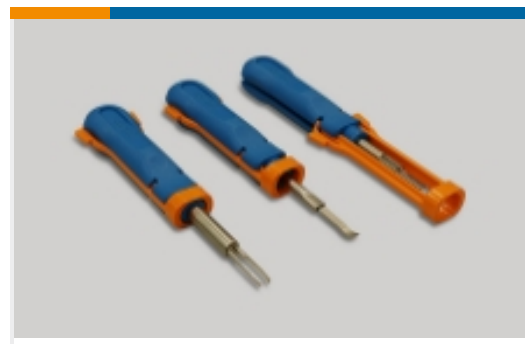

Insertion & Extraction Tools(1)



PCB Connector Keying(2)

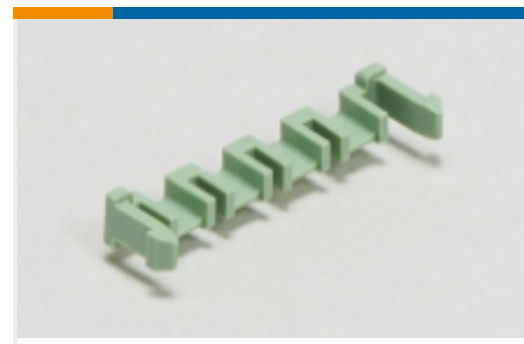

PCB Latches, Locks & Retainers(1)



Rectangular Connector Housings(12)



Rectangular Connector Keying Plugs(1)



Wire-to-Board Connector Assemblies & Housings(158)



Wire-to-Board Connector Contacts(24)

## Customers Also Bought



TE Part #3-647406-1  
SL156 HOODED CONTACT, LID LF



TE Part #3-2176070-8  
3521 360R 1% 2W



TE Part #794287-1  
04P CMNL HDR ASSY BLK HT



TE Part #1-480698-9  
02P UMNL PLUG HSG BLK

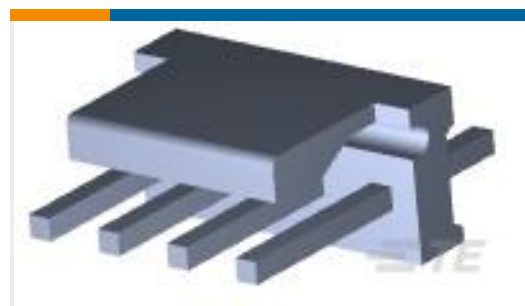

TE Part #644752-4  
04P MTA156 HDR ASSY SQ STR F/L



TE Part #1-154719-0  
PL 250 REC HSG 1P NYLON NAT



TE Part #1-2176330-1  
CRGP 2010 68R 1%

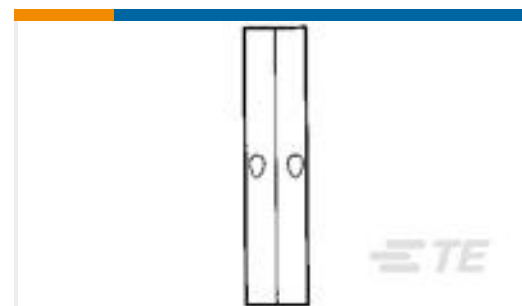

TE Part #34321  
SPLICE,SOLIS BUTT 8

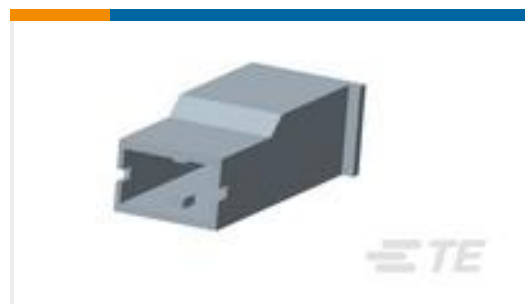

TE Part #4-154719-0  
POSITIVE LOCK (PL) RECEPTACLE



TE Part #NB17744001  
VERSAFIT-1-1/4-0-SP

## Documents



### Product Drawings

#### 02P SL156 HSG W/RAMP,LRG OPEN

English

---

### CAD Files

#### Customer View Model

[ENG\\_CVM\\_CVM\\_647401-2\\_C.2d\\_dxf.zip](#)

English

#### 3D PDF

3D

#### Customer View Model

[ENG\\_CVM\\_CVM\\_647401-2\\_C.3d\\_igs.zip](#)

English

#### Customer View Model

[ENG\\_CVM\\_CVM\\_647401-2\\_C.3d\\_stp.zip](#)

English

By downloading the CAD file I accept and agree to the [Terms and Conditions](#) of use.

---

### Datasheets & Catalog Pages

#### MTA, CST-100 II, SL-156 and AMP Economy Power (EP) Connectors

English

---

### Product Specifications

#### Application Specification

English

---

### Product Environmental Compliance

#### TE Material Declaration

English

---

### Agency Approvals

#### CSA Certificate

English

---