

63982-1 ✓ ACTIVE

FASTON | FASTON 187

TE Internal #: 63982-1

PCB Terminals, Tab, Mating Tab Width 4.75 mm [.187 in], PCB Hole Diameter 1.32 mm [.052 in], Through Hole - Solder, Tin Plating, Brass, FASTON 187

[View on TE.com >](#)



Terminals & Splices > PCB Terminals

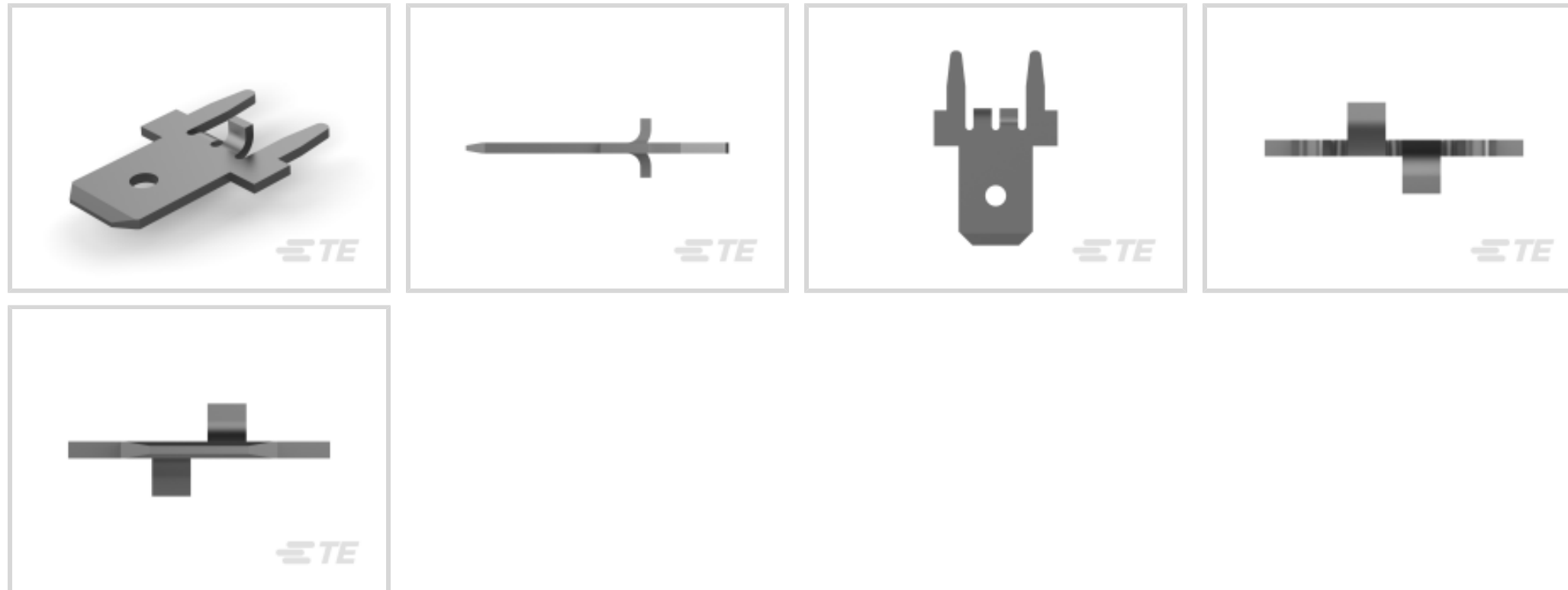

PCB Terminal Type: **Tab**

PCB Thickness (Recommended): 1.57 mm [.062 in]

Mating Tab Width: 4.75 mm [.187 in]

Mating Tab Thickness: .51 mm [.02 in]

PCB Hole Diameter: 1.32 mm [.052 in]

Features

Configuration Features

Stud Hole	Yes
Terminal Angle	180 °

Contact Features

Contact Plating Material	Tin
PCB Terminal Type	Tab
Mating Tab Width	4.75 mm [.187 in]
Mating Tab Thickness	.51 mm [.02 in]
Terminal Plating Material	Tin
Contact Underplating Material	Brass
Terminal Size	4.75
Terminal Orientation	Straight

Termination Features

Termination Method to Printed Circuit Board	Through Hole - Solder
Product Terminates To	Printed Circuit Board



Mechanical Attachment

Wire Insulation Support	With
-------------------------	------

Dimensions

Extension Below Board	3.81 mm[.15 in]
Receptacle Terminal Stock Thickness	.51 mm[.02 in]
Stud Diameter	1.4 mm[.055 in]
PCB Thickness (Recommended)	1.57 mm[.062 in]
PCB Hole Diameter	1.32 mm[.052 in]
Profile Height from PCB	8.63 mm[.344 in]

Usage Conditions

Insulation Option	Uninsulated
Operating Temperature Range	-30 – 110 °C[-22 – 230 °F]

Packaging Features

Packaging Quantity	2000
Packaging Method	Bag

Other

Comment	Insertion equipment available.
---------	--------------------------------

Product Compliance











[For compliance documentation, visit the product page on TE.com>](#)

EU RoHS Directive 2011/65/EU	Compliant
EU ELV Directive 2000/53/EC	Compliant
China RoHS 2 Directive MIIT Order No 32, 2016	No Restricted Materials Above Threshold
EU REACH Regulation (EC) No. 1907/2006	Current ECHA Candidate List: JUNE 2022 (224) Candidate List Declared Against: JAN 2022 (223) SVHC > Threshold: Not Yet Reviewed
Halogen Content	Low Halogen - Br, Cl, F, I < 900 ppm per homogenous material. Also BFR/CFR/PVC Free
Solder Process Capability	Pin-in-Paste capable to 260°C

Product Compliance Disclaimer

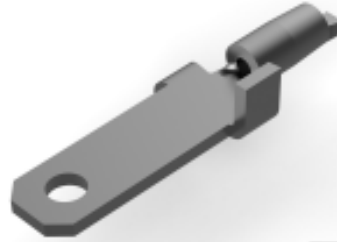
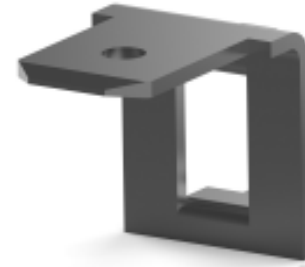
This information is provided based on reasonable inquiry of our suppliers and represents our current actual knowledge based on the information they provided. This information is subject to change. The part numbers that TE has identified as EU RoHS compliant have a maximum concentration of 0.1% by weight in homogenous materials for lead, hexavalent chromium, mercury, PBB, PBDE, DBP, BBP, DEHP, DIBP, and 0.01% for cadmium, or qualify for an exemption to these limits as defined in the Annexes of Directive 2011/65/EU (RoHS2). Finished electrical and electronic equipment products will be CE marked as required by Directive 2011/65/EU. Components may not be CE marked. Additionally, the part numbers that TE has identified as EU ELV compliant have a maximum concentration of 0.1% by weight in homogenous materials for lead, hexavalent chromium, and mercury, and 0.01% for cadmium, or qualify for an exemption to these limits as defined in the Annexes of Directive 2000/53/EC (ELV). Regarding the REACH Regulation, the information TE provides on SVHC in articles for this part number is based on the latest European Chemicals Agency (ECHA) 'Guidance on requirements for substances in articles' posted at this URL: <https://echa.europa.eu/guidance-documents/guidance-on-reach>

Compatible Parts

 <p>TE Part # 1217169-1 250 FASTON,PCB TAB,TCBR</p>	 <p>TE Part # 61134-3 110 FASTON TAB TPBR</p>	 <p>TE Part # 1217057-1 187 FASTON,PCB TAB,TPBR</p>	 <p>TE Part # 1217167-1 250 FASTON,PCB TAB,TCBR</p>
 <p>TE Part # 1217756-1 187 FASTON,TAB,TNBR</p>	 <p>TE Part # 1217156-1 187 FASTON,PCB TAB,TNBR</p>	 <p>TE Part # 62437-1 110 FASTON TAB TPBR</p>	 <p>TE Part # 62747-1 FASTON 187 TAB STAKE TPBR</p>
 <p>TE Part # 1742686-1 250 FASTON,PCB TAB,TCBR</p>	 <p>TE Part # 725996-2 110 FASTON TAB TPBR</p>	 <p>TE Part # 62705-1 187 FASTON TAB TPBR</p>	 <p>TE Part # 1217421-1 250 FASTON,PCB TAB,TNBR</p>

Also in the Series | **FASTON 187**



Crimp Terminal Housings(41)



Insertion & Extraction Tools(1)

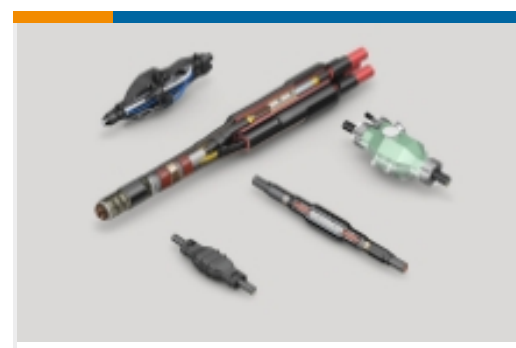

Joints & Splices(1)



PCB Terminals(48)



Quick Disconnects(214)



Splices(1)

Customers Also Bought

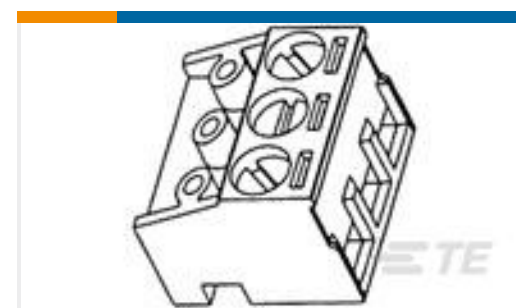
TE Part #292303-5
Std USB Type A, R/A, T/H, NaturalTE Part #5145323-1
SMT CARD CONN LOW PROFILE
8POSTE Part #1721261-5
OJE-SS-112LMH2TE Part #282830-3
TERMI-BLOK PLUG 90&180 3P. 5TE Part #1986525-2
Hi Rise Header, 5.0mm, 2 posnTE Part #1986525-4
Hi Rise Header, 5.0mm, 4 posnTE Part #1217133-4
187 FASTON,PCB TAB,TNBR

Documents

Product Drawings

[187 FASTON TAB TPBR](#)

English

CAD Files

[3D PDF](#)

[3D](#)

[Customer View Model](#)

[ENG_CVM_CVM_63982-1_H_c-63982-1-h.2d_dxf.zip](#)



English

Customer View Model

[ENG_CVM_CVM_63982-1_H_c-63982-1-h.3d_igs.zip](#)

English

Customer View Model

[ENG_CVM_CVM_63982-1_H_c-63982-1-h.3d_stp.zip](#)

English

By downloading the CAD file I accept and agree to the [Terms and Conditions](#) of use.

Datasheets & Catalog Pages

[FASTON PCB Tabs and Receptacles](#)

English

[PRINTED CIRCUIT BOARD TERMINALS AND DISCONNECTS](#)

English

Product Specifications

[Application Specification](#)

English

Product Environmental Compliance

[MD_63982-1_11062017243_dmtec](#)

English

[MD_63982-1_11062017243_dmtec](#)

English