

63650-1 ✓ ACTIVE

FASTON | FASTON 250

TE Internal #: 63650-1

PCB Terminals, Tab, Mating Tab Width 6.35 mm [.25 in], PCB Hole Diameter 1.4 mm [.055 in], Through Hole - Solder, Tin Plating, Brass, Reel, FASTON 250

[View on TE.com >](#)



Terminals & Splices > PCB Terminals

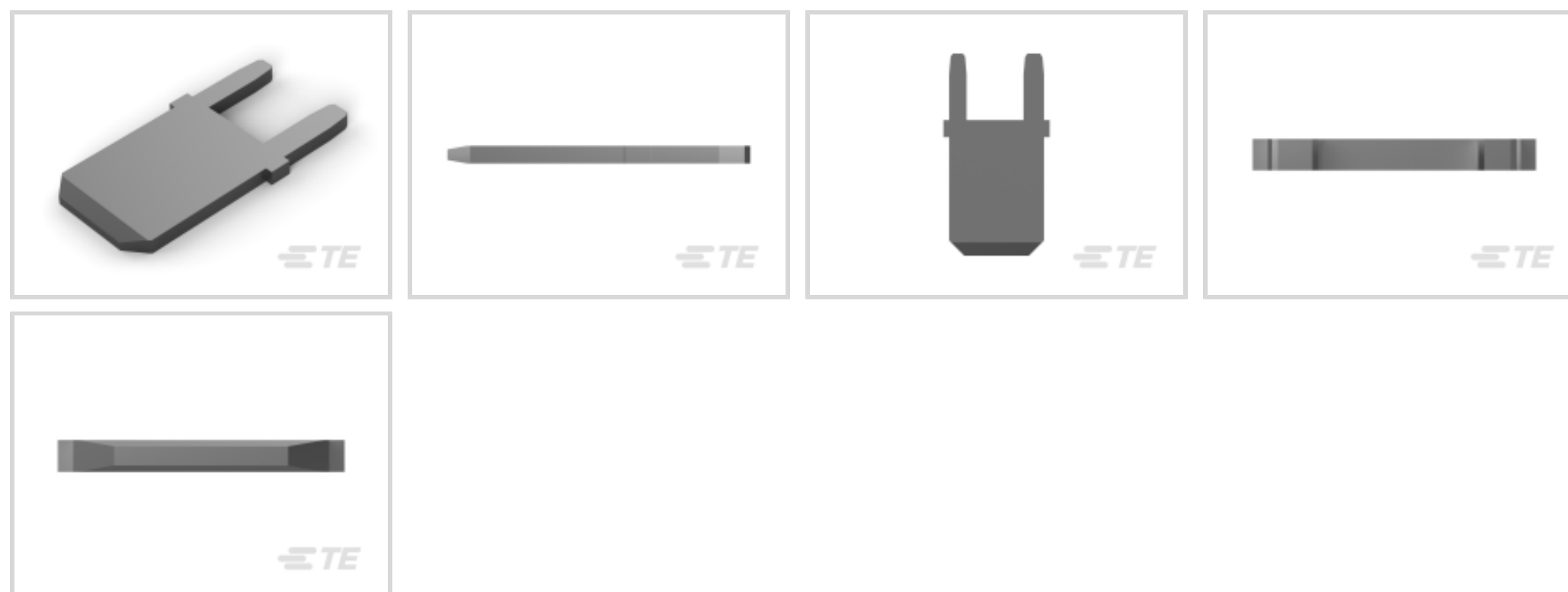

PCB Terminal Type: **Tab**

PCB Thickness (Recommended): **4.45 mm [.175 in]**

Mating Tab Width: **6.35 mm [.25 in]**

Mating Tab Thickness: **.81 mm [.032 in]**

PCB Hole Diameter: **1.4 mm [.055 in]**

Features

Configuration Features

Stud Hole	No
Terminal Angle	180 °

Contact Features

Contact Plating Material	Tin
PCB Terminal Type	Tab
Mating Tab Width	6.35 mm[.25 in]
Mating Tab Thickness	.81 mm[.032 in]
Terminal Plating Material	Tin
Contact Underplating Material	Brass
Terminal Size	6.35
Terminal Orientation	Straight

Termination Features

Termination Method to Printed Circuit Board	Through Hole - Solder
Product Terminates To	Printed Circuit Board



Mechanical Attachment

Wire Insulation Support	With
-------------------------	------

Dimensions

Extension Below Board	4.44 mm[.175 in]
Receptacle Terminal Stock Thickness	.81 mm[.032 in]
PCB Thickness (Recommended)	4.45 mm[.175 in]
PCB Hole Diameter	1.4 mm[.055 in]
Profile Height from PCB	9.06 mm[.361 in]

Usage Conditions

Insulation Option	Uninsulated
Operating Temperature Range	-30 – 110 °C[-22 – 230 °F]

Industry Standards

CSA Certified	Yes
UL Rating	Recognized

Packaging Features

Packaging Quantity	6000
Packaging Method	Reel

Other

Comment	Insertion equipment available.
---------	--------------------------------

Product Compliance

[For compliance documentation, visit the product page on TE.com>](#)

EU RoHS Directive 2011/65/EU	Compliant
EU ELV Directive 2000/53/EC	Compliant
China RoHS 2 Directive MIIT Order No 32, 2016	No Restricted Materials Above Threshold
EU REACH Regulation (EC) No. 1907/2006	Current ECHA Candidate List: JUNE 2022 (224) Candidate List Declared Against: JAN 2022 (223) SVHC > Threshold: Not Yet Reviewed
Halogen Content	Low Halogen - Br, Cl, F, I < 900 ppm per homogenous material. Also BFR/CFR/PVC Free

Solder Process Capability

Pin-in-Paste capable to 260°C

Product Compliance Disclaimer

This information is provided based on reasonable inquiry of our suppliers and represents our current actual knowledge based on the information they provided. This information is subject to change. The part numbers that TE has identified as EU RoHS compliant have a maximum concentration of 0.1% by weight in homogenous materials for lead, hexavalent chromium, mercury, PBB, PBDE, DBP, BBP, DEHP, DIBP, and 0.01% for cadmium, or qualify for an exemption to these limits as defined in the Annexes of Directive 2011/65/EU (RoHS2). Finished electrical and electronic equipment products will be CE marked as required by Directive 2011/65/EU. Components may not be CE marked. Additionally, the part numbers that TE has identified as EU ELV compliant have a maximum concentration of 0.1% by weight in homogenous materials for lead, hexavalent chromium, and mercury, and 0.01% for cadmium, or qualify for an exemption to these limits as defined in the Annexes of Directive 2000/53/EC (ELV). Regarding the REACH Regulation, the information TE provides on SVHC in articles for this part number is based on the latest European Chemicals Agency (ECHA) 'Guidance on requirements for substances in articles' posted at this URL: <https://echa.europa.eu/guidance-documents/guidance-on-reach>

Compatible Parts

 <p>TE Part # 63066-1 250 FASTON TAB TPBR</p>	 <p>TE Part # 63525-1 187 FASTON TAB TPBR</p>	 <p>TE Part # 63986-1 250 FASTON TAB TPBR</p>	 <p>TE Part # 1217127-1 250 FASTON,PCB TAB,TPBR</p>
 <p>TE Part # 1217125-1 250 FASTON,PCB TAB,TPBR</p>	 <p>TE Part # 1217155-1 250 FASTON,PCB TAB,TCBR</p>	 <p>TE Part # 1217154-1 250 FASTON,PCB TAB,TCBR</p>	 <p>TE Part # 62650-1 250 FASTON TAB TPBR</p>
 <p>TE Part # 63755-1 250 FASTON TAB TPBR</p>	 <p>TE Part # 1217126-1 250 FASTON,PCB TAB,TPBR</p>	 <p>TE Part # 1217539-1 250 FASTON,PCB TAB,TCBR</p>	 <p>TE Part # 63839-1 250 FASTON TAB TPBR</p>

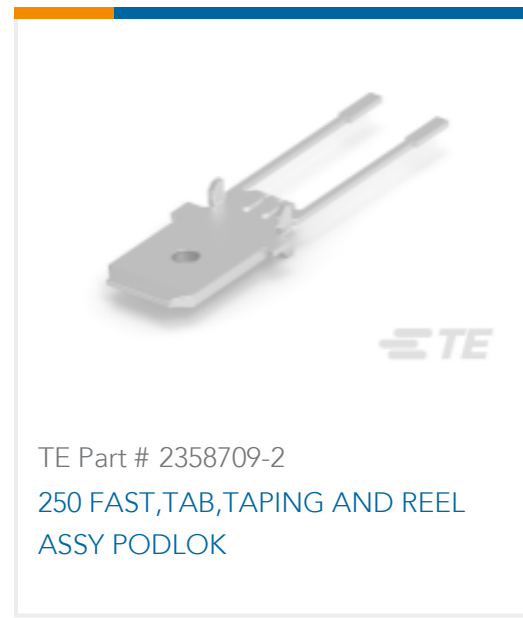

Also in the Series | FASTON 250

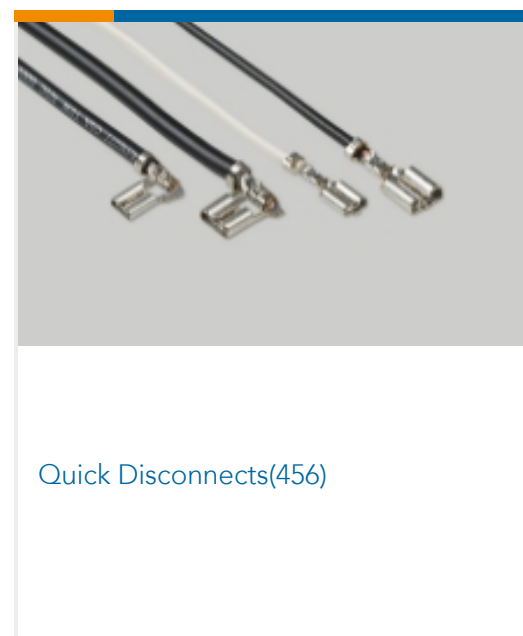
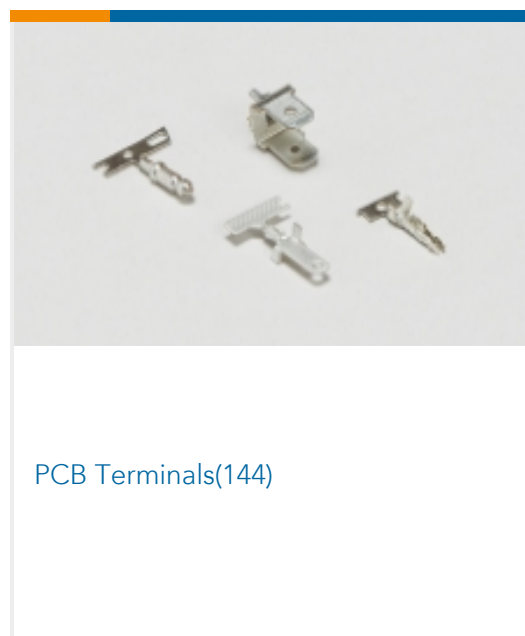
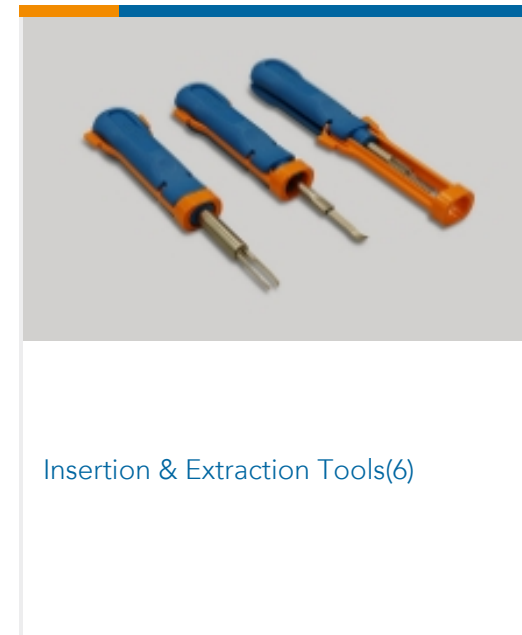
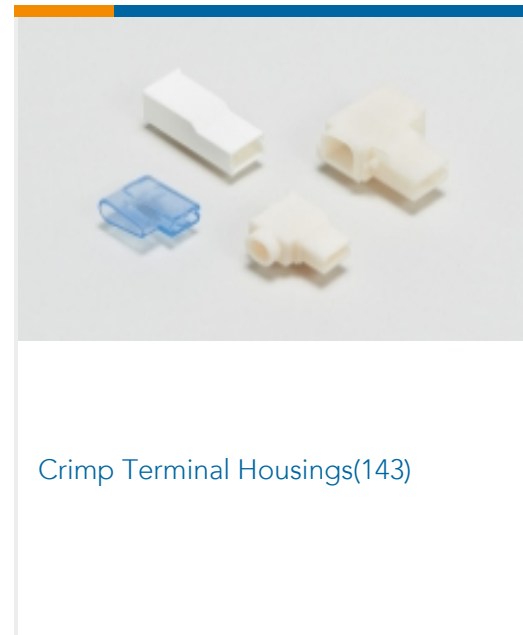
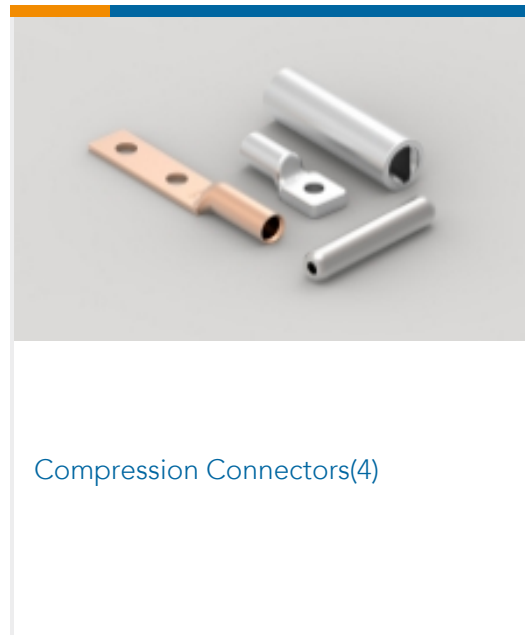

Customers Also Bought

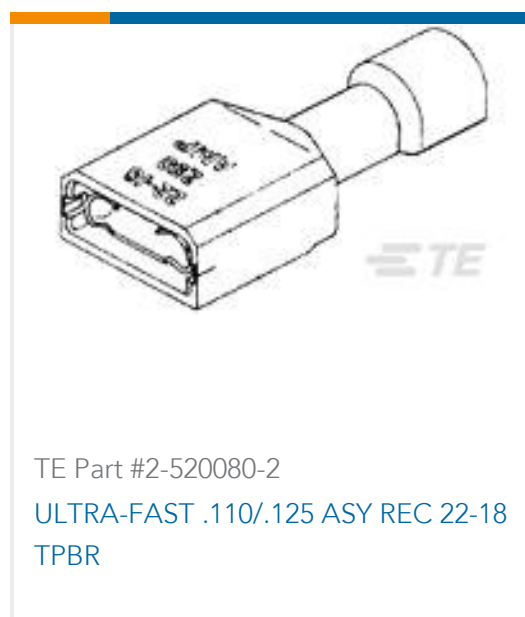
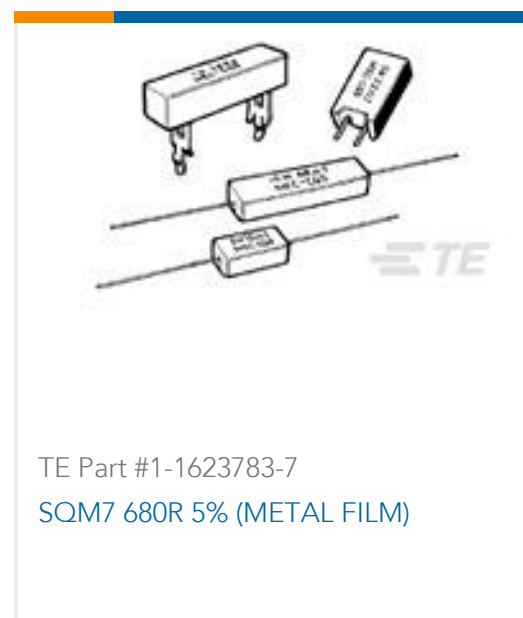



Documents

Product Drawings

250 FASTON TAB TPBR

English

CAD Files

3D PDF

3D

Customer View Model

[ENG_CVM_CVM_63650-1_M_c-63650-1-m.2d_dxf.zip](#)

English

Customer View Model

[ENG_CVM_CVM_63650-1_M_c-63650-1-m.3d_igs.zip](#)

English

Customer View Model

[ENG_CVM_CVM_63650-1_M_c-63650-1-m.3d_stp.zip](#)

English

By downloading the CAD file I accept and agree to the [Terms and Conditions](#) of use.

Datasheets & Catalog Pages

FASTON PCB Tabs and Receptacles

English

PRINTED CIRCUIT BOARD TERMINALS AND DISCONNECTS

English

Product Specifications

Application Specification

English

Product Environmental Compliance

MD_63650-1_12162013357_dmtec

English

MD_63650-1_12162013357_dmtec

English

Agency Approvals

CSA Certificate

63650-1

PCB Terminals, Tab, Mating Tab Width 6.35 mm [.25 in], PCB Hole Diameter 1.4 mm [.055 in], Through Hole - Solder, Tin Plating, Brass, Reel, FASTON 250



English

[CSA Certificate](#)

English