

MTA 156

TE Internal #: 640383-2

Rectangular Power Connectors, Header, Plug, Wire-to-Board, 2

Position, .156 in [3.96 mm] Centerline, Printed Circuit Board, UL 94V-

0, MTA 156

[View on TE.com >](#)

Connectors > Power Connectors > Rectangular Power > Rectangular Power Connectors

Rectangular Power Connector Type: **Header**Connector & Housing Type: **Plug**Connector System: **Wire-to-Board**Number of Positions: **2**Centerline (Pitch): **3.96 mm [.156 in]****Features****Product Type Features**

Header Type	Unshrouded
Rectangular Power Connector Type	Header
Connector & Housing Type	Plug
Connector System	Wire-to-Board
Sealable	No
Connector & Contact Terminates To	Printed Circuit Board

Configuration Features

Number of Positions	2
PCB Mount Orientation	Vertical
Number of Power Positions	2
Number of Rows	1

Electrical Characteristics

Operating Voltage	600 VAC
-------------------	---------

Contact Features



Contact Layout	Inline
Contact Underplating Material	Nickel
Contact Base Material	Copper Alloy
Contact Current Rating (Max)	7 A
Contact Retention Within Housing	Without
Contact Type	Pin
PCB Contact Termination Area Plating Material	Tin
Contact Mating Area Plating Material	Tin
Contact Mating Area Plating Material Thickness	2.54 μm [100 μin]
Contact Termination Area Plating Thickness	3.81 – 8.89 μm [150 – 350 μin]

Termination Features

Termination Post & Tail Length	3.56 mm[.14 in]
Termination Method to Printed Circuit Board	Through Hole - Solder

Mechanical Attachment

Strain Relief	Without
Mating Alignment	Without
PCB Mount Alignment	Without
Panel Mount Feature	Without
PCB Mount Retention	Without
Connector Mounting Type	Board Mount
Mating Retention	Without

Housing Features

Centerline (Pitch)	3.96 mm[.156 in]
Housing Color	Natural
Housing Material	Polyester - GF

Dimensions

PCB Thickness (Recommended)	1.6 mm[.063 in]
Mating Post Length	10.16 mm[.4 in]
Length	7.92 mm[.312 in]

Usage Conditions

Operating Temperature Range	-55 – 105 $^{\circ}\text{C}$ [-67 – 221 $^{\circ}\text{F}$]
-----------------------------	--

Operation/Application



Circuit Application	Power
---------------------	-------

Industry Standards

CSA Rating	Certified
UL Flammability Rating	UL 94V-0
Glow Wire Rating	Standard Part - Not Glow Wire
Agency/Standard Number	E28476
Agency/Standard	CSA, UL
UL Rating	Recognized
CSA File Number	LR7189

Packaging Features

Packaging Method	Bag
Packaging Quantity	2000

Other

For Use With	MTA .156 Connector Assembly or SL .156 Connector Assembly
--------------	---

Product Compliance

[For compliance documentation, visit the product page on TE.com>](#)

EU RoHS Directive 2011/65/EU	Compliant
EU ELV Directive 2000/53/EC	Compliant
China RoHS 2 Directive MIIT Order No 32, 2016	No Restricted Materials Above Threshold
EU REACH Regulation (EC) No. 1907/2006	Current ECHA Candidate List: JUNE 2022 (224) Candidate List Declared Against: JAN 2022 (223) SVHC > Threshold: Not Yet Reviewed
Halogen Content	Not Low Halogen - contains Br or Cl > 900 ppm.
Solder Process Capability	Wave solder capable to 265°C

Product Compliance Disclaimer

This information is provided based on reasonable inquiry of our suppliers and represents our current actual knowledge based on the information they provided. This information is subject to change. The part numbers that TE has identified as EU RoHS compliant have a maximum concentration of 0.1% by weight in homogenous materials for lead, hexavalent chromium, mercury, PBB, PBDE, DBP, BBP, DEHP, DIBP, and 0.01% for cadmium, or qualify for an exemption to these limits as defined in the Annexes of Directive 2011/65/EU (RoHS2). Finished electrical and electronic equipment products will be CE marked as required by Directive 2011/65/EU. Components may not be CE marked. Additionally, the part numbers that TE has identified as EU ELV compliant have a maximum concentration of 0.1% by weight in homogenous

materials for lead, hexavalent chromium, and mercury, and 0.01% for cadmium, or qualify for an exemption to these limits as defined in the Annexes of Directive 2000/53/EC (ELV). Regarding the REACH Regulation, the information TE provides on SVHC in articles for this part number is based on the latest European Chemicals Agency (ECHA) 'Guidance on requirements for substances in articles' posted at this URL: <https://echa.europa.eu/guidance-documents/guidance-on-reach>

Compatible Parts





TE Part # 3-640431-2
02P MTA156 CONN ASSY 18AWG
ORA



TE Part # 3-640428-2
02P MTA156 CONN ASSY 22AWG RED



TE Part # 3-640601-2
02P MTA156 CONN ASSY 22AWG LF



TE Part # 3-640602-2
02P MTA156 CONN ASSY 24AWG LF

Also in the Series | MTA 156



Insertion & Extraction Tools(1)



PCB Connector Covers(92)



PCB Connector Keying(2)

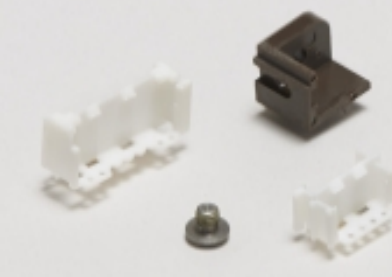

PCB Connector Mounting(1)



PCB Headers & Receptacles(729)



Power Contacts(3)



Rectangular Caps & Covers(1)



Rectangular Power Connectors(749)



Standard Rectangular Connectors
(1309)



Wire-to-Board Connector Contacts(12)

Customers Also Bought



TE Part #5747236-6
15 MSFL PLUG RA 318 (SL,FM)



TE Part #5499374-4
AMP-LATCH UNIVERSAL HEADERS

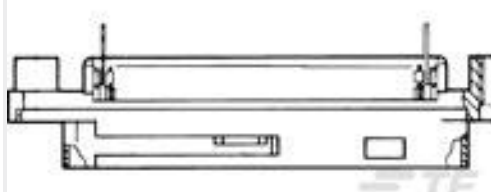

TE Part #5552116-1
ASSY, PLUG, 50 POS, VERT MTG



TE Part #796644-2
2POS 5.0MM CE R/A HDR,TRM BLK



Documents

Product Drawings

[02P MTA156 HDR ASSY STR SQ SN](#)

English

CAD Files

Customer View Model

[ENG_CVM_CVM_640383-2_AD.2d_dxf.zip](#)

English

[3D PDF](#)

3D

Customer View Model

[ENG_CVM_CVM_640383-2_AD.3d_igs.zip](#)

English

Customer View Model

[ENG_CVM_CVM_640383-2_AD.3d_stp.zip](#)

English

By downloading the CAD file I accept and agree to the [Terms and Conditions](#) of use.

Datasheets & Catalog Pages

[MTA, CST-100 II, SL-156 and AMP Economy Power \(EP\) Connectors](#)

English

Product Specifications

[Product Specification](#)

English

Product Environmental Compliance

[TE Material Declaration](#)

English

Agency Approvals

[Agency Approval Document](#)

English

[Agency Approval Document](#)

English