

63316-3 ✓ ACTIVE

FASTON | FASTON 187

TE Internal #: 63316-3

Quick Disconnects, Receptacle, 18 – 14 AWG Wire Size, .82 – 2.08 mm<sup>2</sup> Wire Size, Mating Tab Width .187 in [4.75 mm], Flag, Steel, FASTON 187

[View on TE.com >](#)



Terminals & Splices > Quick Disconnects

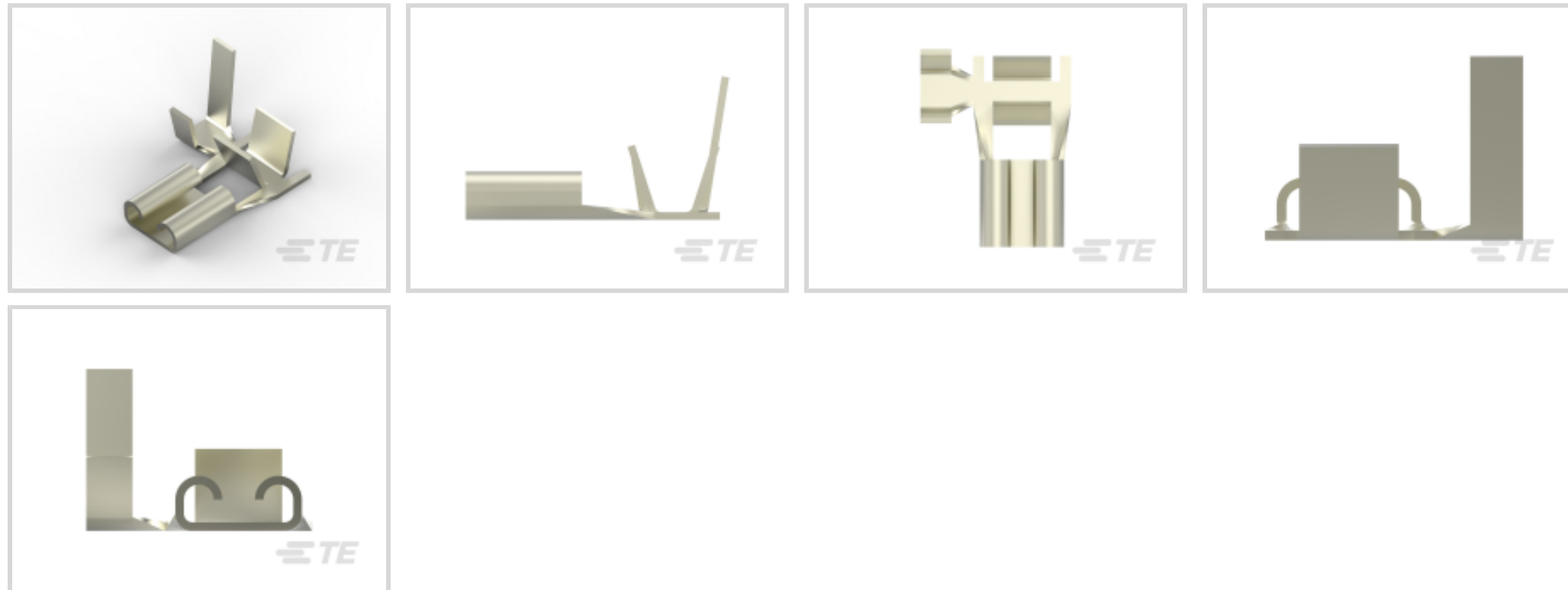

Quick Disconnect Terminal Type: **Receptacle**

Wire Size: **.82 – 2.08 mm<sup>2</sup>**

Mating Tab Width: **4.75 mm [ .187 in ]**

Mating Tab Thickness: **.81 mm [ .032 in ]**

## Features

### Product Type Features

Terminates To	Wire & Cable
Wire Stop	No
Wire/Cable Type	Regular Wire
Insertion Force	Normal
Sealable	No

### Configuration Features

Connection Capacity	Single
---------------------	--------

### Contact Features

Quick Disconnect Terminal Type	Receptacle
Mating Tab Width	4.75 mm[.187 in]
Mating Tab Thickness	.81 mm[.032 in]
Terminal Orientation	Flag
Contact Base Material	Steel
Terminal Plating Material	Nickel
Crimp Type	F-Crimp

Barrel Type	Open
-------------	------

### Mechanical Attachment

Mating Retention Type	Dimple
Wire Insulation Support	With

### Dimensions

Accepts Wire Insulation Diameter Range	1.52 – 3.81 mm [.06 – .15 in]
Overall Length	10.92 mm [.43 in]
Receptacle Terminal Stock Thickness	.41 mm [.016 in]
Wire Size	.82 – 2.08 mm <sup>2</sup>

### Usage Conditions

Insulation Option	Uninsulated
Operating Temperature Range	-40 – 250 °C [-40 – 482 °F]

### Industry Standards

UL Rating	Listed
-----------	--------

### Packaging Features

Packaging Quantity	7500
Packaging Method	Strip/Reel

### Other

Line	Budget
------	--------

## Product Compliance

[For compliance documentation, visit the product page on TE.com>](#)

EU RoHS Directive 2011/65/EU	Compliant
EU ELV Directive 2000/53/EC	Compliant
China RoHS 2 Directive MIIT Order No 32, 2016	No Restricted Materials Above Threshold
EU REACH Regulation (EC) No. 1907/2006	Current ECHA Candidate List: JUNE 2022 (224) Candidate List Declared Against: JAN 2021 (211) SVHC > Threshold: Not Yet Reviewed
Halogen Content	Low Halogen - Br, Cl, F, I < 900 ppm per homogenous material. Also BFR/CFR/PVC Free

Solder Process Capability

Not applicable for solder process capability

Product Compliance Disclaimer

This information is provided based on reasonable inquiry of our suppliers and represents our current actual knowledge based on the information they provided. This information is subject to change. The part numbers that TE has identified as EU RoHS compliant have a maximum concentration of 0.1% by weight in homogenous materials for lead, hexavalent chromium, mercury, PBB, PBDE, DBP, BBP, DEHP, DIBP, and 0.01% for cadmium, or qualify for an exemption to these limits as defined in the Annexes of Directive 2011/65/EU (RoHS2). Finished electrical and electronic equipment products will be CE marked as required by Directive 2011/65/EU. Components may not be CE marked. Additionally, the part numbers that TE has identified as EU ELV compliant have a maximum concentration of 0.1% by weight in homogenous materials for lead, hexavalent chromium, and mercury, and 0.01% for cadmium, or qualify for an exemption to these limits as defined in the Annexes of Directive 2000/53/EC (ELV). Regarding the REACH Regulation, the information TE provides on SVHC in articles for this part number is based on the latest European Chemicals Agency (ECHA) 'Guidance on requirements for substances in articles' posted at this URL: <https://echa.europa.eu/guidance-documents/guidance-on-reach>

## Compatible Parts



## Also in the Series | FASTON 187

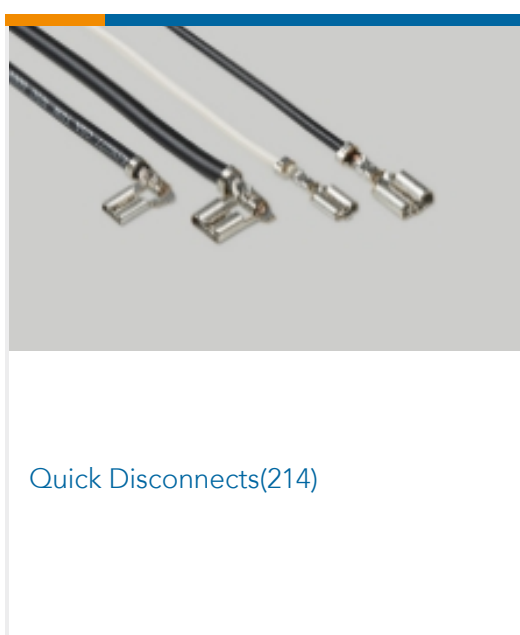
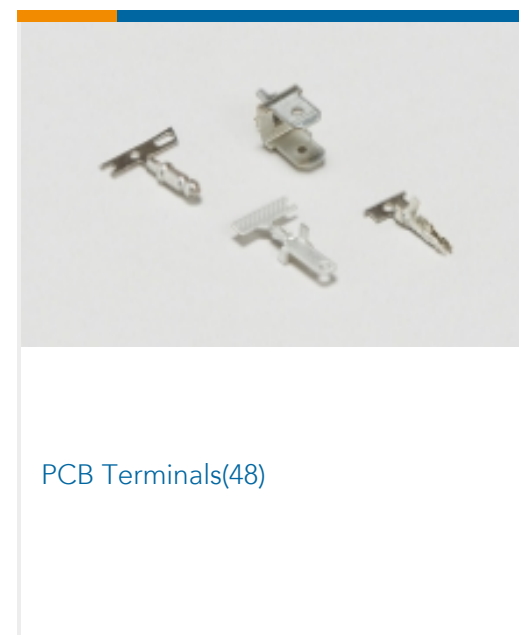
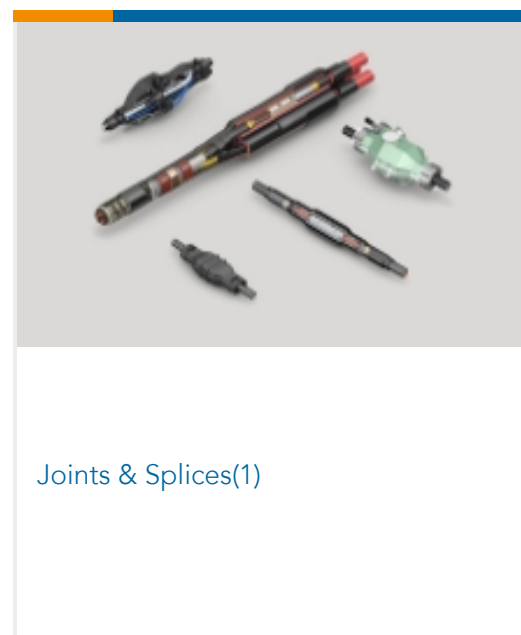
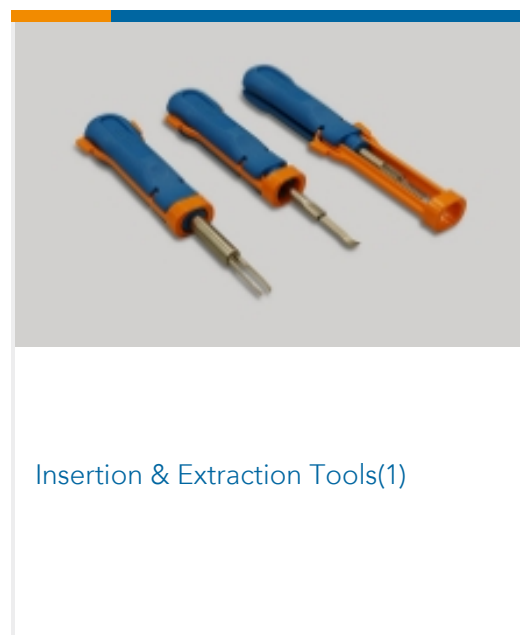
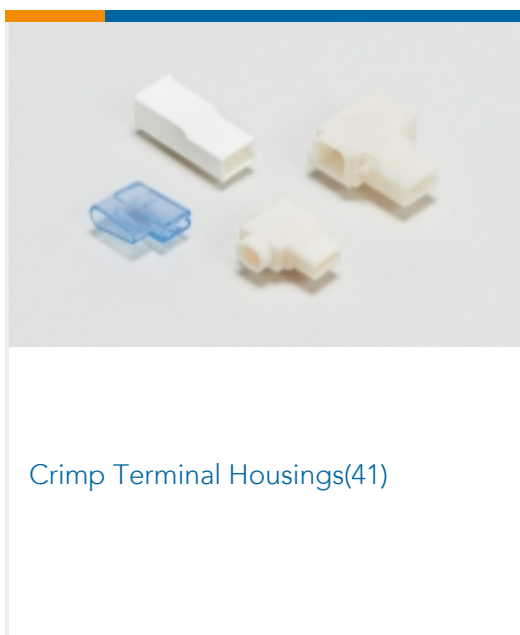

## Customers Also Bought

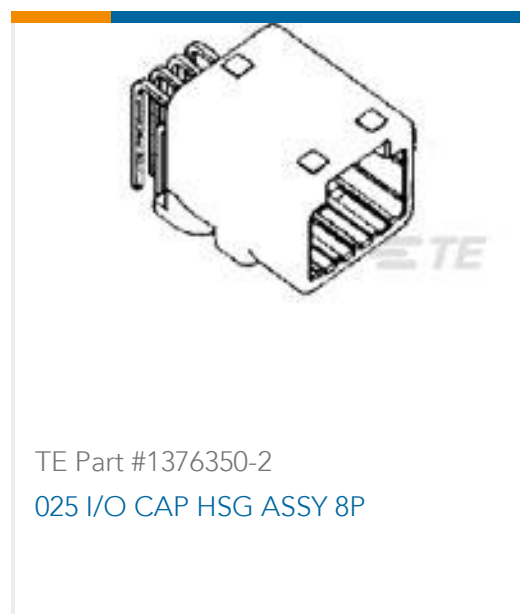

## Documents

### Product Drawings

[187 FASTON FLAG REC 18-14 AWG NPST](#)

English

### CAD Files

[3D PDF](#)

3D

Customer View Model

[ENG\\_CVM\\_CVM\\_63316-3\\_AK.2d\\_dxf.zip](#)

English

Customer View Model

[ENG\\_CVM\\_CVM\\_63316-3\\_AK.3d\\_igs.zip](#)

English

Customer View Model

[ENG\\_CVM\\_CVM\\_63316-3\\_AK.3d\\_stp.zip](#)

English

By downloading the CAD file I accept and agree to the [Terms and Conditions](#) of use.

### Datasheets & Catalog Pages

[82004 FASTON Terminals \(Insulated and Uninsulated\) Catalog - FASTON Receptacles Section](#)

English

### Product Specifications

[Application Specification](#)

English

### Agency Approvals

[Agency Approval Document](#)

English