

63668-1 ✓ ACTIVE

## MAG-MATE

TE Internal #: 63668-1

Magnet Wire Terminals, Tab, Mating Tab Width .02 in [4.78 mm],  
Size 1, 18.5 – 16.5 AWG Aluminum Wire, .73 – 1.17 mm Aluminum  
Wire, MAG-MATE

[View on TE.com >](#)



Terminals & Splices > Magnet Wire Terminals

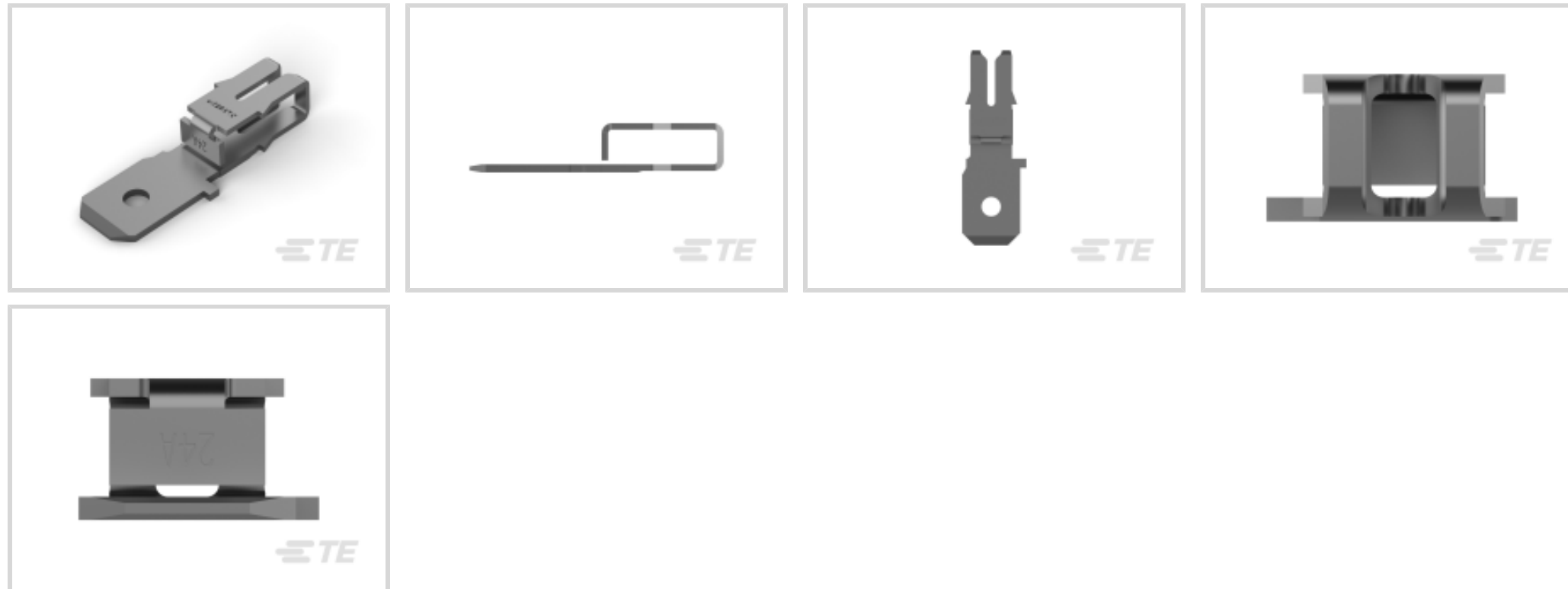

Magnet Wire Terminal Type: **Tab**

Mating Tab Width: **4.78 mm [ .02 in ]**

Mating Tab Thickness: **.51 mm [ .02 in ]**

Compatible With Cavity Size: **Size 1**

Aluminum Wire Size: **.73 – 1.17 mm**

### Features

#### Product Type Features

Compatible With Discrete Wire Type	Magnet Wire, Solid
Sealable	No

#### Body Features

Compatible With Cavity Size	Size 1
-----------------------------	--------

#### Contact Features

Magnet Wire Terminal Type	Tab
Mating Tab Width	4.78 mm[.02 in]
Mating Tab Thickness	.51 mm[.02 in]
Terminal Plating Material	Tin
Terminal Orientation	Straight

#### Termination Features

Termination Method to Wire & Cable	Insulation Displacement (IDC)
------------------------------------	-------------------------------

#### Mechanical Attachment



Contact Mating Retention Type	Hole
-------------------------------	------

### Dimensions

Terminal Height	7.68 mm[.3 in]
Aluminum Wire Size	18.5 – 16.5 AWG
Magnet Wire Size	.97 – 1.22 mm
Stock Thickness (Magnet Wire Side)	.41 mm[.016 in]
Overall Product Length	16 mm[.63 in]

### Usage Conditions

Insulation Option	Uninsulated
Operating Temperature Range	-65 – 150 °C[-85 – 302 °F]

### Operation/Application

Compatible With Wire Base Material	Aluminum
------------------------------------	----------

### Packaging Features

Packaging Method	Reel, Reel/Carton
------------------	-------------------

### Other

Comment	After insertion into plastic cavity, tab portion must be bent over 45°-90° or potted in to prevent pullout when mating receptacle is disconnected., Single aluminum magnet wire only., Single magnet wire only.
---------	-----------------------------------------------------------------------------------------------------------------------------------------------------------------------------------------------------------------

## Product Compliance







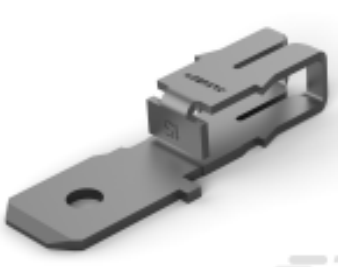

[For compliance documentation, visit the product page on TE.com>](#)

EU RoHS Directive 2011/65/EU	Compliant
EU ELV Directive 2000/53/EC	Compliant
China RoHS 2 Directive MIIT Order No 32, 2016	No Restricted Materials Above Threshold
EU REACH Regulation (EC) No. 1907/2006	Current ECHA Candidate List: JUNE 2022 (224) Candidate List Declared Against: JAN 2022 (223) SVHC > Threshold: Not Yet Reviewed
Halogen Content	Low Halogen - Br, Cl, F, I < 900 ppm per homogenous material. Also BFR/CFR/PVC Free
Solder Process Capability	Not applicable for solder process capability

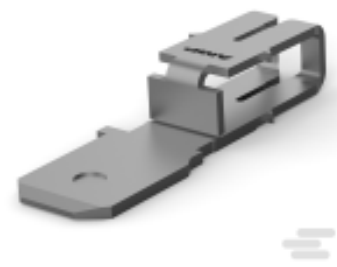
## Product Compliance Disclaimer

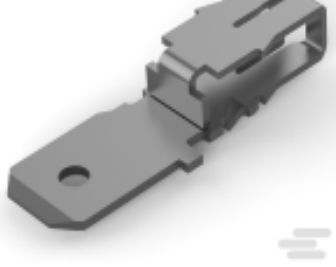
This information is provided based on reasonable inquiry of our suppliers and represents our current actual knowledge based on the information they provided. This information is subject to change. The part numbers that TE has identified as EU RoHS compliant have a maximum concentration of 0.1% by weight in homogenous materials for lead, hexavalent chromium, mercury, PBB, PBDE, DBP, BBP, DEHP, DIBP, and 0.01% for cadmium, or qualify for an exemption to these limits as defined in the Annexes of Directive 2011/65/EU (RoHS2). Finished electrical and electronic equipment products will be CE marked as required by Directive 2011/65/EU. Components may not be CE marked. Additionally, the part numbers that TE has identified as EU ELV compliant have a maximum concentration of 0.1% by weight in homogenous materials for lead, hexavalent chromium, and mercury, and 0.01% for cadmium, or qualify for an exemption to these limits as defined in the Annexes of Directive 2000/53/EC (ELV). Regarding the REACH Regulation, the information TE provides on SVHC in articles for this part number is based on the latest European Chemicals Agency (ECHA) 'Guidance on requirements for substances in articles' posted at this URL: <https://echa.europa.eu/guidance-documents/guidance-on-reach>

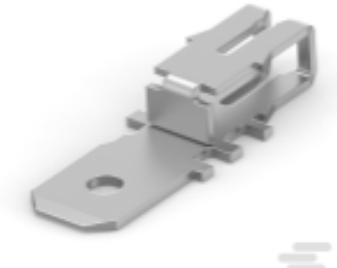
## Compatible Parts

 <p>TE Part # 63664-2 MAG-MATE 27-23 187 FTAB TPBR</p>	 <p>TE Part # 63663-1 MAG-MATE 22-20 187 FTAB TPBR</p>	 <p>TE Part # 63663-2 MAG-MATE 22-20 187 FTAB TPBR</p>	 <p>TE Part # 63664-1 MAG-MATE 27-23 187 FTAB TPBR</p>
 <p>TE Part # 62511-1 MAG-MATE 22-20 187 F TAB TPBR</p>	 <p>TE Part # 63669-1 MAG-MATE 187 F-TAB TPBR</p>	 <p>TE Part # 63713-2 TAB,187 MAG-MATE SLIM LN 082 B</p>	 <p>TE Part # 63340-1 MAG-MATE 187 FTAB #23 TPBR</p>
 <p>TE Part # 62511-2 MAG-MATE 22-20 187 F TAB TPBR</p>	 <p>TE Part # 63668-3 MAG-MATE 187 F-TAB TPBR REV REEL</p>	 <p>TE Part # 2825062-1 MAG-MATE 22-20 187 FTAB TPBR</p>	

Also in the Series | **MAG-MATE**

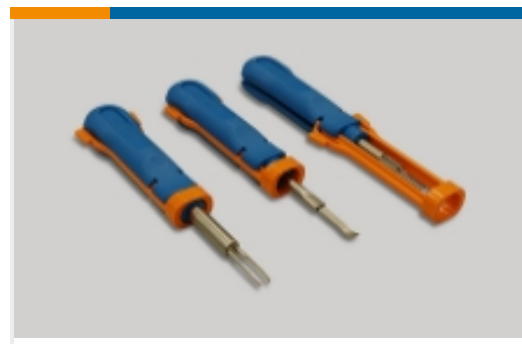

Insertion &amp; Extraction Tools(8)



Magnet Wire Terminals(464)



PCB Terminals(1)

## Customers Also Bought



TE Part #1-327743-1  
TERMINAL,PIDG R 16-14HD 1/4



TE Part #2315539-1  
COVER, LIGHT CONTROLLER, 81MM  
DIA., 62MM



TE Part #1-2213629-2  
CONN, INLINE VERT SCRWLESS,  
SPECIAL PACK



TE Part #2213629-3  
ASY,IN-LINE VERT SCRLESS,SPECIAL  
PACK



TE Part #2271203-1  
2PIN WIRE TO WIRE CONNECTOR



TE Part #63665-1  
MAG-MATE 187 FAST TAB 020TPBR

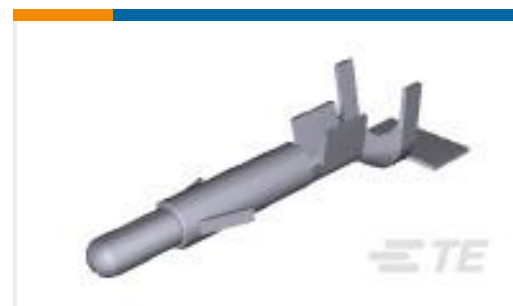

TE Part #350700-2  
UMNL SPLIT PIN AU/NI/BR

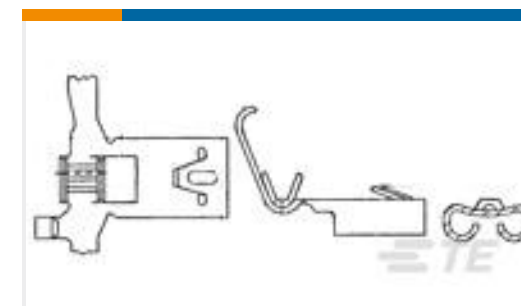

TE Part #63509-1  
FF 187 REC 20-16AWG TPBR



TE Part #63863-1  
TWIST LOCK RECEPTACLE 18-14  
AWG TPPHBZ

## Documents

### Product Drawings

[MAG-MATE 187 F-TAB TPBR](#)

English

### CAD Files

[3D PDF](#)

3D

[Customer View Model](#)

[ENG\\_CVM\\_CVM\\_63668-1\\_J.2d\\_dxf.zip](#)



English

**Customer View Model**

[ENG\\_CVM\\_CVM\\_63668-1\\_J.3d\\_igs.zip](#)

English

**Customer View Model**

[ENG\\_CVM\\_CVM\\_63668-1\\_J.3d\\_stp.zip](#)

English

By downloading the CAD file I accept and agree to the [Terms and Conditions](#) of use.

---

**Datasheets & Catalog Pages**

[Magnet Wire Terminals & Splices](#)

English

---

**Product Specifications**

[Application Specification](#)

English

---

**Product Environmental Compliance**

[MD\\_63668-1\\_09022015221\\_dmtec](#)

English

[MD\\_63668-1\\_09022015221\\_dmtec](#)

English