

60618-1 ✓ ACTIVE

MATE-N-LOK | Commercial MATE-N-LOK

TE Internal #: 60618-1

Power Contacts, Contact, 250 VAC, Pre-Tin, 24 – 18 AWG Wire Size,  
.2 – .82 mm<sup>2</sup> Wire Size, Wire-to-Wire, Wire & Cable, Crimp,  
Commercial MATE-N-LOK

[View on TE.com >](#)



Connectors > Power Connectors > Power Contacts

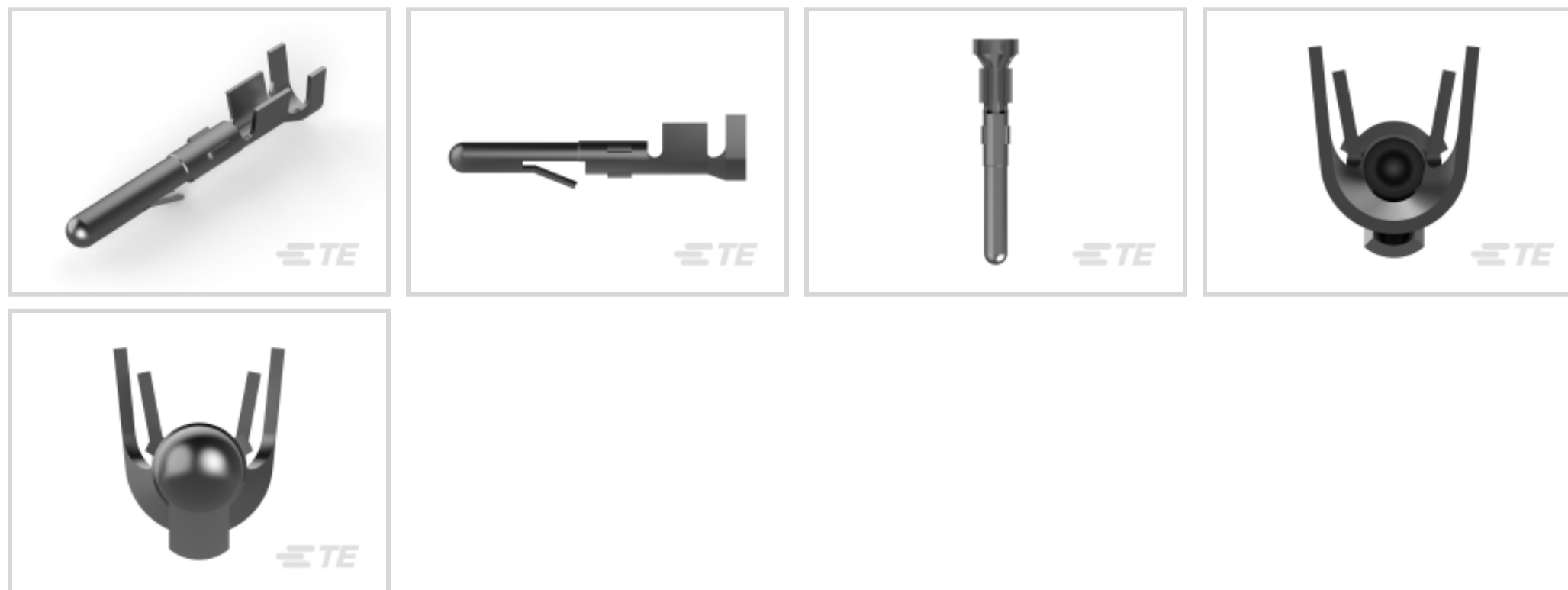

Power Contact Type: **Contact**

Operating Voltage: **250 VAC**

Contact Mating Area Plating Material: **Pre-Tin**

Wire Size: **.2 – .82 mm<sup>2</sup>**

## Features

### Product Type Features

Power Contact Type	Contact
Connector System	Wire-to-Wire
Connector & Contact Terminates To	Wire & Cable

### Electrical Characteristics

Operating Voltage	250 VAC
-------------------	---------

### Contact Features

Contact Shape & Form	Round
Contact Mating Area Plating Material	Pre-Tin
Contact Current Rating (Max)	15 A
Contact Type	Pin
Contact Retention Within Housing	With
Mating Pin Diameter	2.13 mm [.084 in]
Contact Base Material	Brass
Wire Contact Termination Area Plating Thickness	.508 – .812 μm [20 – 32 μin]
Wire Contact Termination Area Plating Material	Tin



Wire Contact Termination Area Plating Material Finish	Matte
Contact Orientation	Straight
Barrel Type	Open Barrel

#### Termination Features

Termination Method to Wire & Cable	Crimp
------------------------------------	-------

#### Mechanical Attachment

Contact Retention Type Within Housing	Locking Lance
Connector Mounting Type	Cable Mount (Free-Hanging)
Wire Insulation Support	Without

#### Dimensions

Wire Size	.2 – .82 mm <sup>2</sup>
Accepts Wire Insulation Diameter Range	2.54 mm[.1 in]

#### Usage Conditions

Operating Temperature Range	-55 – 105 °C[-67 – 221 °F]
-----------------------------	----------------------------

#### Operation/Application

Circuit Application	Power
---------------------	-------

#### Industry Standards

Glow Wire Rating	Standard Part - Not Glow Wire
VDE Tested	No

#### Packaging Features

Packaging Method	Bag
Packaging Quantity	1000

#### Other

Wire/Cable Type	Discrete Wire
Wire Type	Stranded
For Use With	Pin (Cap) Housing

#### Product Compliance

[For compliance documentation, visit the product page on TE.com>](#)

EU RoHS Directive 2011/65/EU	Compliant
EU ELV Directive 2000/53/EC	Compliant

China RoHS 2 Directive MIIT Order No 32, 2016

No Restricted Materials Above Threshold

EU REACH Regulation (EC) No. 1907/2006

Current ECHA Candidate List: JUNE 2022 (224)

Candidate List Declared Against: JAN 2022 (223)

SVHC &gt; Threshold:

Not Yet Reviewed

Halogen Content

Low Halogen - Br, Cl, F, I &lt; 900 ppm per homogenous material. Also BFR/CFR/PVC Free

Solder Process Capability

Not applicable for solder process capability

## Product Compliance Disclaimer

This information is provided based on reasonable inquiry of our suppliers and represents our current actual knowledge based on the information they provided. This information is subject to change. The part numbers that TE has identified as EU RoHS compliant have a maximum concentration of 0.1% by weight in homogenous materials for lead, hexavalent chromium, mercury, PBB, PBDE, DBP, BBP, DEHP, DIBP, and 0.01% for cadmium, or qualify for an exemption to these limits as defined in the Annexes of Directive 2011/65/EU (RoHS2). Finished electrical and electronic equipment products will be CE marked as required by Directive 2011/65/EU. Components may not be CE marked. Additionally, the part numbers that TE has identified as EU ELV compliant have a maximum concentration of 0.1% by weight in homogenous materials for lead, hexavalent chromium, and mercury, and 0.01% for cadmium, or qualify for an exemption to these limits as defined in the Annexes of Directive 2000/53/EC (ELV). Regarding the REACH Regulation, the information TE provides on SVHC in articles for this part number is based on the latest European Chemicals Agency (ECHA) 'Guidance on requirements for substances in articles' posted at this URL: <https://echa.europa.eu/guidance-documents/guidance-on-reach>

## Compatible Parts

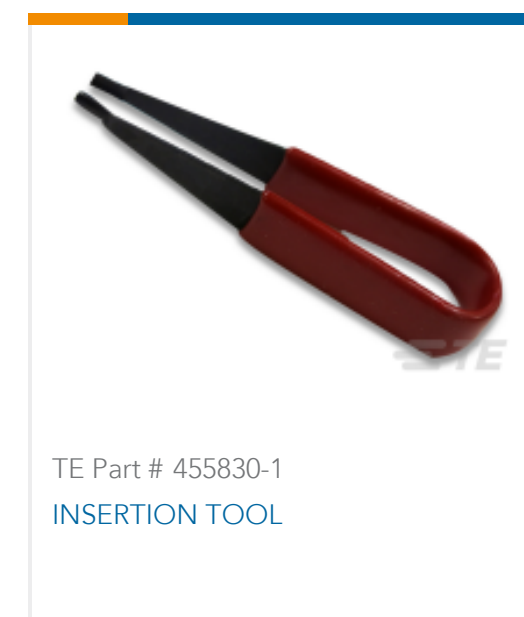



TE Part # 1-480683-0  
02P CMNL PLUG HSG F/H NATL



TE Part # 1-480277-0  
09P CMNL CAP HSG P/M NATL



TE Part # 1-480304-0  
03P CMNL PLUG HSG P/M NATL



TE Part # 1-480722-0  
04P CMNL PLUG HSG W/LCK NATL



TE Part # 1-480276-0  
06P CMNL CAP HSG P/M NATL



TE Part # 1-480285-0  
10P CMNL PLUG HSG M/M NATL



TE Part # 1-480439-0  
16P CMNL CAP HSG M/M NATL



TE Part # 1-480393-1  
02P CMNL PLUG HSG F/H BLK



TE Part # 1-480345-0  
08P CMNL CAP HSG F/H NATL



TE Part # 1-480340-0  
06P CMNL CAP HSG F/H NATL



TE Part # 1-480278-0  
12P CMNL CAP HSG P/M NATL



TE Part # 1-480425-0  
04P CMNL PLUG HSG P/M NATL

## Also in the Series | Commercial MATE-N-LOK



Connector Contacts(26)



Crimp Wire Pins, Tabs & Ferrules(3)



Insertion & Extraction Tools(5)



Power Contacts(129)



Rectangular Caps & Covers(2)



Rectangular Connector Housings(17)



Rectangular Connector Seals(1)



Rectangular Power Connectors(170)



Standard Circular Connectors(4)



Standard Rectangular Connectors(10)



Wire-to-Board Connector Contacts(1)

## Customers Also Bought

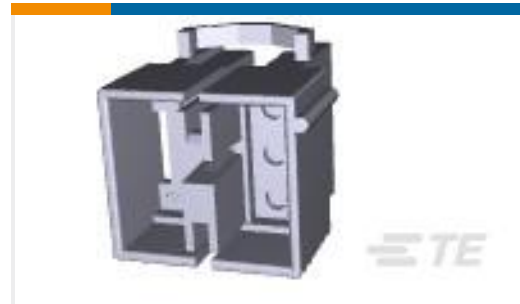
TE Part #1-480345-0  
08P CMNL CAP HSG F/H NATLTE Part #1-480340-0  
06P CMNL CAP HSG F/H NATLTE Part #1-480424-0  
04P CMNL PLUG HSG F/H NATLTE Part #1-480303-0  
03P CMNL PLUG HSG F/H NATLTE Part #1-480318-0  
02P CMNL PLUG HSG F/H NATLTE Part #170148-1  
MATE-N-LOK SOC LPTE Part #1617807-6  
FC-335-SY9=RELAY, 3PSTTE Part #3-1609989-1  
16BCF6R=F8233FTE Part #1-480387-0  
03P CMNL CAP HSG F/H BLK

## Documents

### Product Drawings

CMNL PIN PTPBR L/P

English

### CAD Files

3D PDF

English

### Customer View Model

ENG\_CVM\_60618-1\_S.2d\_dxf.zip



English

Customer View Model

[ENG\\_CVM\\_60618-1\\_S.3d\\_igs.zip](#)

English

Customer View Model

[ENG\\_CVM\\_60618-1\\_S.3d\\_stp.zip](#)

English

[3D PDF](#)

3D

Customer View Model

[ENG\\_CVM\\_CVM\\_60618-1\\_Y.2d\\_dxf.zip](#)

English

Customer View Model

[ENG\\_CVM\\_CVM\\_60618-1\\_Y.3d\\_igs.zip](#)

English

Customer View Model

[ENG\\_CVM\\_CVM\\_60618-1\\_Y.3d\\_stp.zip](#)

English

By downloading the CAD file I accept and agree to the [Terms and Conditions](#) of use.

---

### Datasheets & Catalog Pages

[SOFT\\_SHELL\\_PIN\\_SOCKET\\_CONNECTORS\\_STANDARD\\_DENSITY](#)

English

---

### Product Specifications

[Application Specification](#)

English

---

### Product Environmental Compliance

[MD\\_60618-1\\_06142018143\\_dmtec](#)

English

[MD\\_60618-1\\_06142018143\\_dmtec](#)

English

---

### Instruction Sheets

[Instruction Sheet \(U.S.\)](#)

English