

640907-1 ✓ ACTIVE

PIDG

TE Internal #: 640907-1

Quick Disconnects, Receptacle, 12 – 10 AWG Wire Size, 2.62 – 6.64 mm² Wire Size, 5180 – 13100 CMA Wire Size, Mating Tab Width .25 in [6.35 mm], PIDG

[View on TE.com >](#)



Terminals & Splices > Quick Disconnects > PIDG FASTON RECPT QUICK DISCONNECTS

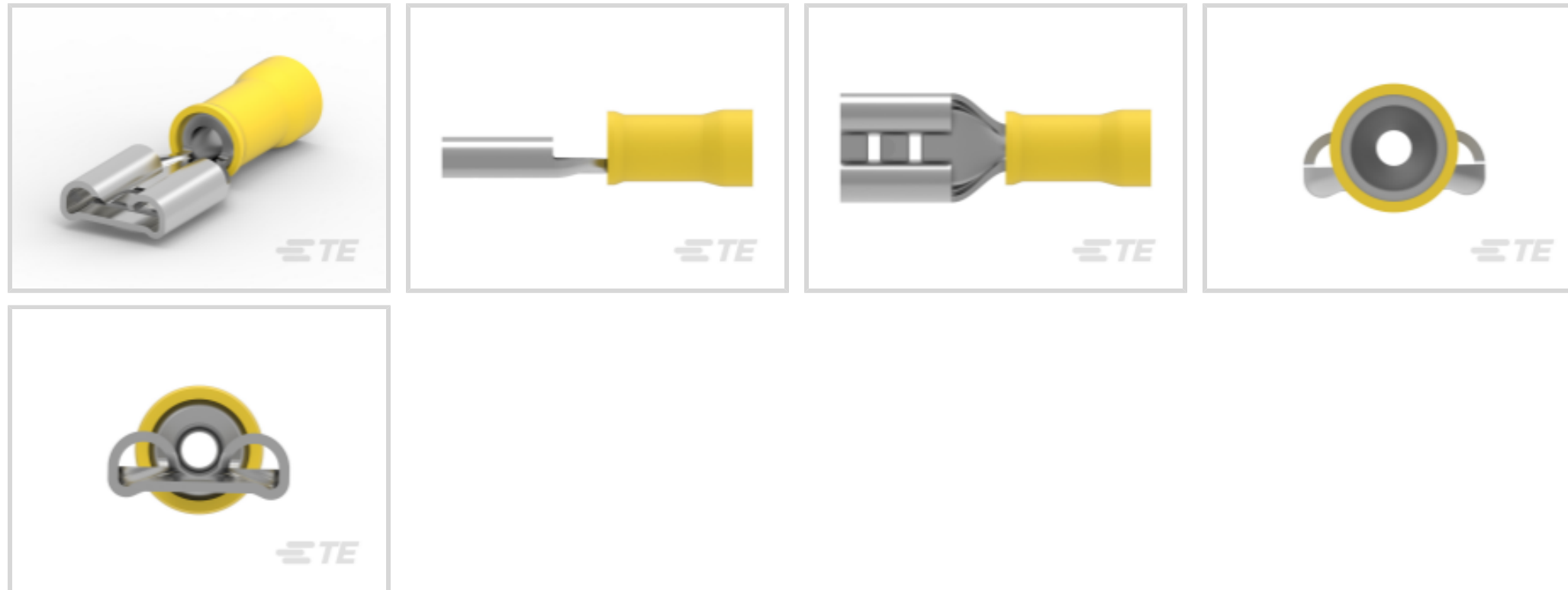

Quick Disconnect Terminal Type: **Receptacle**

Wire Size: **5180 – 13100 CMA**

Mating Tab Width: **6.35 mm [.25 in]**

[All PIDG FASTON RECPT QUICK DISCONNECTS \(25\)](#)

Features

Product Type Features

Terminates To	Wire & Cable
Wire Stop	Yes
Insertion Force	Normal
Sealable	No

Electrical Characteristics

Voltage (Max)	300 V
---------------	-------

Body Features

Insulation Material	Nylon
---------------------	-------

Contact Features

Quick Disconnect Terminal Type	Receptacle
Mating Tab Width	6.35 mm[.25 in]
Mating Tab Thickness	.81 mm[.032 in]
Terminal Orientation	Straight
Contact Base Material	Brass



Terminal Plating Material	Tin
Crimp Type	Compression
Barrel Type	Closed

Mechanical Attachment

Mating Retention Type	Dimple
Wire Insulation Support	With

Dimensions

Accepts Wire Insulation Diameter Range	6.35 mm[.25 in]
Receptacle Terminal Stock Thickness	.46 mm[.018 in]
Overall Length	25.75 mm[1.012 in]
Wire Size	5180 – 13100 CMA

Usage Conditions

Insulation Option	Partially Insulated
Operating Temperature Range	105 °C[221 °F]

Industry Standards

RU (UL Component Program)	Approved
CSA Certified	Yes

Packaging Features

Packaging Quantity	500
Packaging Method	Loose Piece

Other

Barrel Color	Yellow
--------------	--------

Product Compliance

[For compliance documentation, visit the product page on TE.com>](#)

EU RoHS Directive 2011/65/EU	Compliant
EU ELV Directive 2000/53/EC	Compliant
China RoHS 2 Directive MIIT Order No 32, 2016	No Restricted Materials Above Threshold
EU REACH Regulation (EC) No. 1907/2006	Current ECHA Candidate List: JUNE 2022 (224) Candidate List Declared Against: JUNE 2022 (224) Does not contain REACH SVHC



Halogen Content

Low Halogen - Br, Cl, F, I < 900 ppm per homogenous material. Also BFR/CFR/PVC Free

Solder Process Capability

Not applicable for solder process capability

Product Compliance Disclaimer

This information is provided based on reasonable inquiry of our suppliers and represents our current actual knowledge based on the information they provided. This information is subject to change. The part numbers that TE has identified as EU RoHS compliant have a maximum concentration of 0.1% by weight in homogenous materials for lead, hexavalent chromium, mercury, PBB, PBDE, DBP, BBP, DEHP, DIBP, and 0.01% for cadmium, or qualify for an exemption to these limits as defined in the Annexes of Directive 2011/65/EU (RoHS2). Finished electrical and electronic equipment products will be CE marked as required by Directive 2011/65/EU. Components may not be CE marked. Additionally, the part numbers that TE has identified as EU ELV compliant have a maximum concentration of 0.1% by weight in homogenous materials for lead, hexavalent chromium, and mercury, and 0.01% for cadmium, or qualify for an exemption to these limits as defined in the Annexes of Directive 2000/53/EC (ELV). Regarding the REACH Regulation, the information TE provides on SVHC in articles for this part number is based on the latest European Chemicals Agency (ECHA) 'Guidance on requirements for substances in articles' posted at this URL: <https://echa.europa.eu/guidance-documents/guidance-on-reach>

Compatible Parts



Also in the Series | PIDG

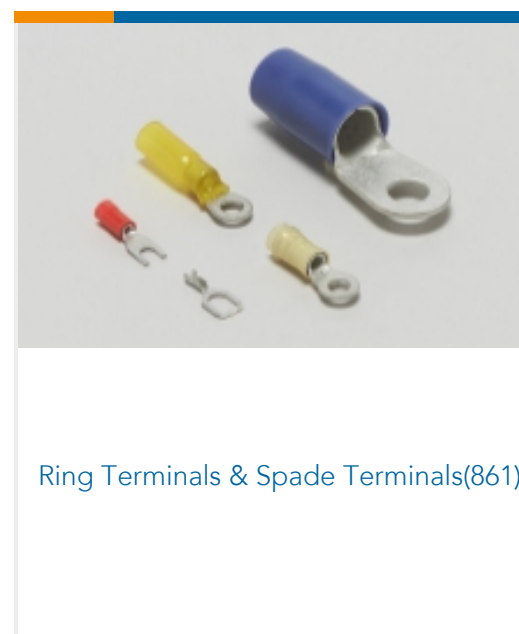
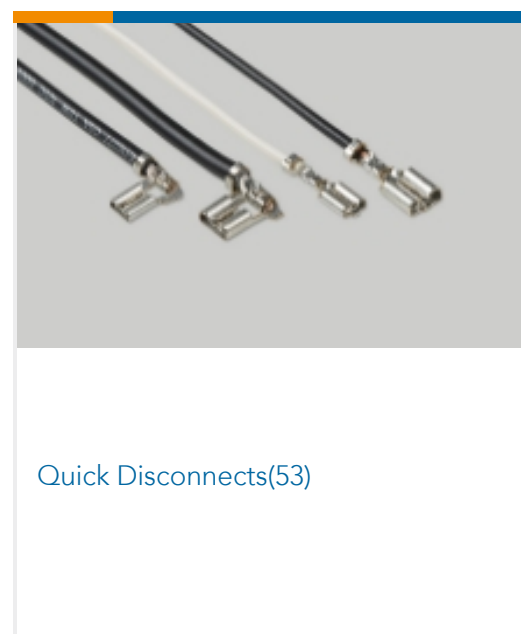
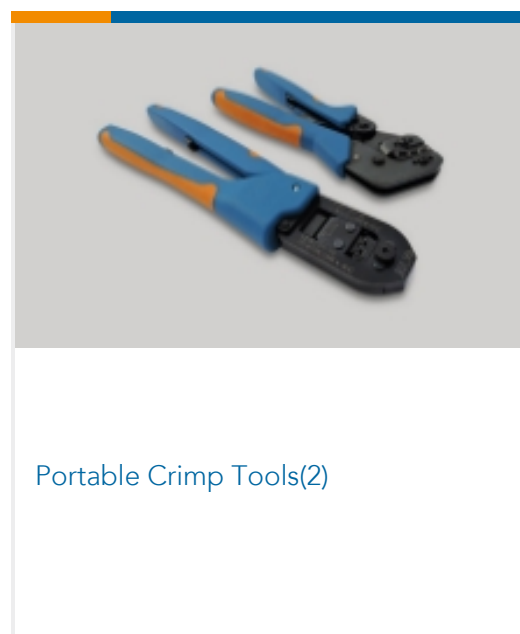
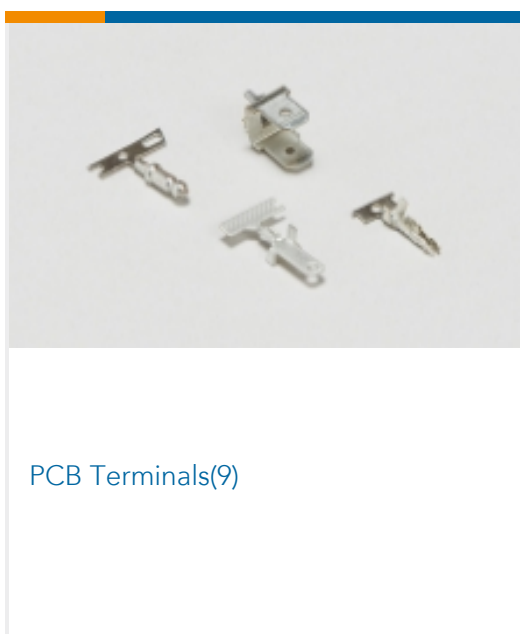
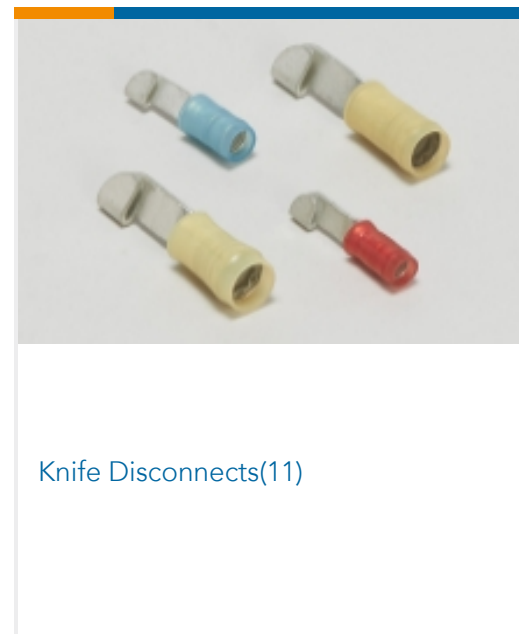
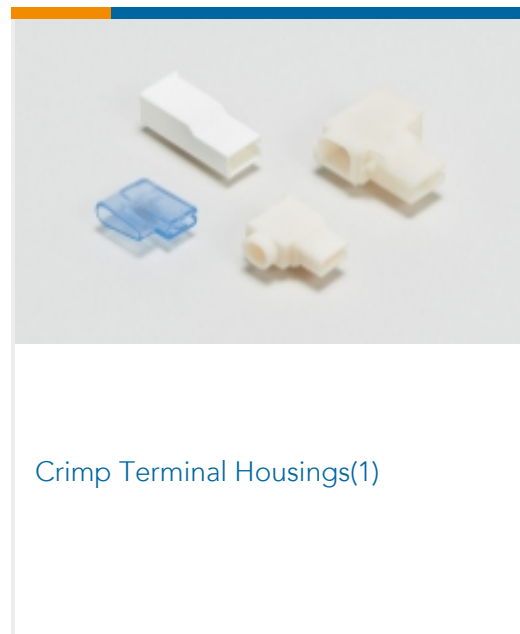
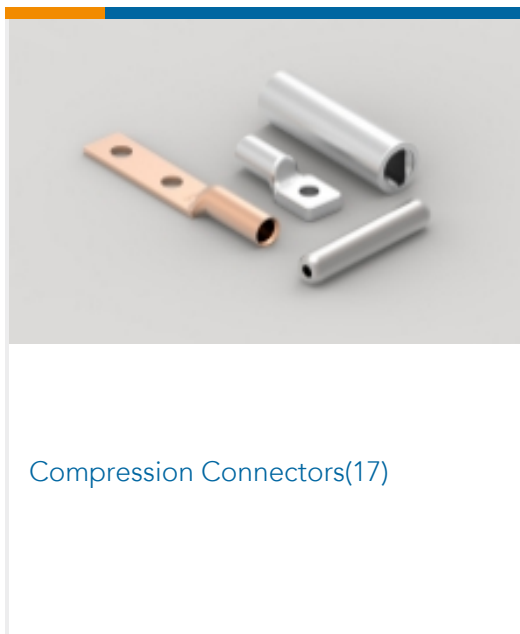

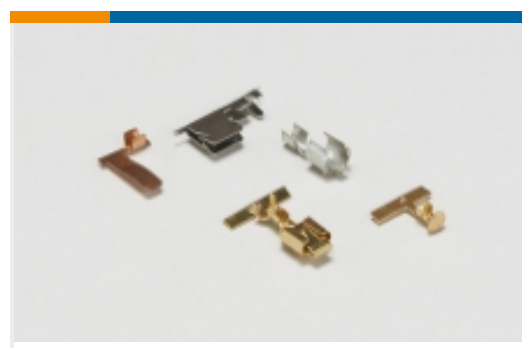

Special Purpose Terminals(1)



Splices(48)

Customers Also Bought

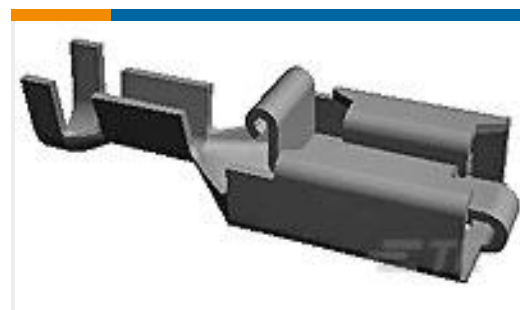
TE Part #52943
TERMINAL,PIDG SPR SPD 12-10 10TE Part #30928
TERMINAL,DG R 16-14 10TE Part #2176330-2
CRGP 2010 12R 1%TE Part #2176330-3
CRGP 2010 15R 1%TE Part #3-644878-2
02P MTA156 ASSY ON TAPE LFTE Part #170266-2
POSITIVE LOCK RECEPTACLE
ELECTRO TPBRTE Part #34159
TERMINAL,PG R 16-14 6TE Part #2-552076-1
KIT, COVER, 180 DEG, 24 POSTE Part #1SNS320001Z3269
RC610 CUSTOM PRINTED MARKERSTE Part #20010725-09
PRESS XDCR U535D-000005-150PG

Documents

Product Drawings

[RECEPT,PIDG FASTON 12-10 250](#)

English

CAD Files

[Customer View Model](#)

[ENG_CVM_CVM_640907-1_J.2d_dxf.zip](#)

English

[3D PDF](#)



3D

Customer View Model

[ENG_CVM_CVM_640907-1_J.3d_igs.zip](#)

English

Customer View Model

[ENG_CVM_CVM_640907-1_J.3d_stp.zip](#)

English

By downloading the CAD file I accept and agree to the [Terms and Conditions](#) of use.

Datasheets & Catalog Pages

[PIDG_FASTON](#)

English

[Ultra-Fast and Ultra Fast Plus](#)

English

[PIDG TERMINALS & SPLICES Quick Reference Guide](#)

English

Product Specifications

[Application Specification](#)

English

Product Environmental Compliance

[MD_640907-1_03292018653_dmtec](#)

English

[MD_640907-1_03292018653_dmtec](#)

English

Agency Approvals

[UL Report](#)

English