

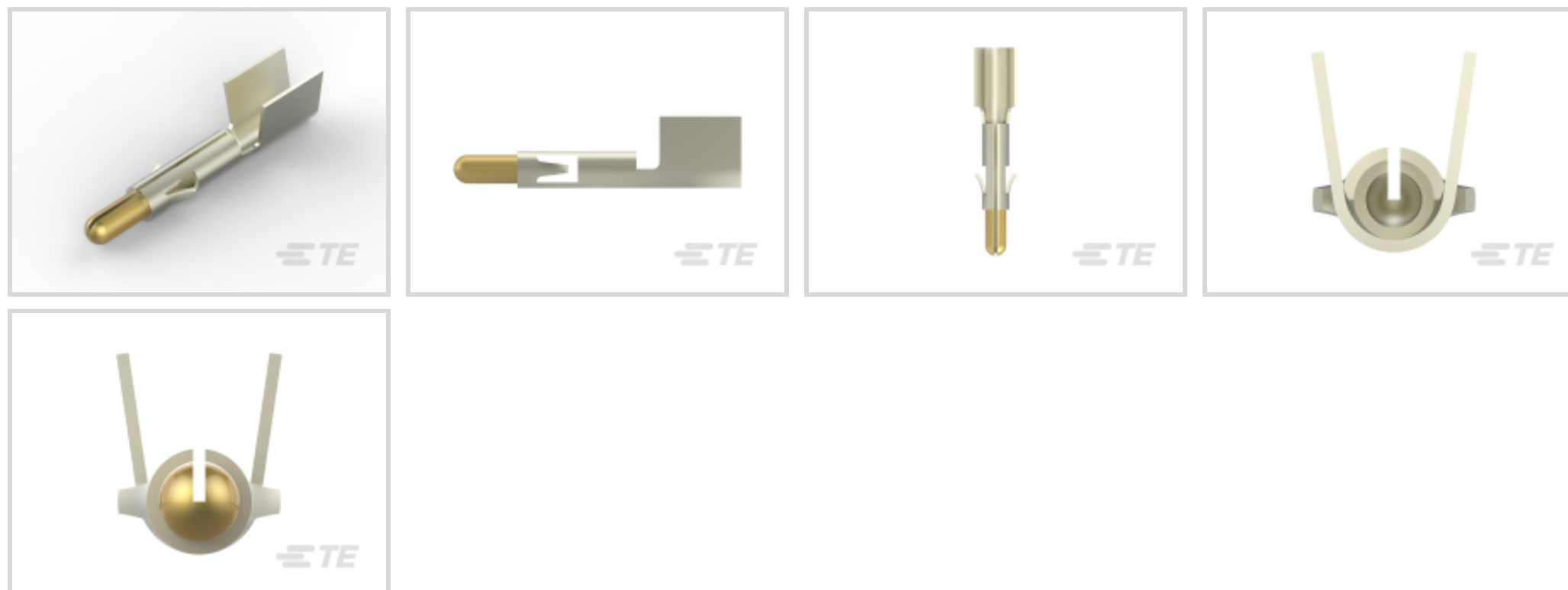

Connectors > Power Connectors > Power Contacts

Power Contact Type: **Contact**Operating Voltage: **600 VAC**Contact Mating Area Plating Material: **Gold**Wire Size: **3.31 – 5.26 mm²**

Features

Product Type Features

Power Contact Type	Contact
Connector System	Wire-to-Wire
Connector & Contact Terminates To	Wire & Cable

Electrical Characteristics

Operating Voltage	600 VAC
-------------------	---------

Contact Features

Contact Mating Area Plating Material	Gold
Contact Current Rating (Max)	19 A
Contact Type	Pin
Contact Retention Within Housing	With
Mating Pin Diameter	2.13 mm [.084 in]
Contact Base Material	Phosphor Bronze
Contact Mating Area Plating Material Thickness	.76 μm [30 μin]
Wire Contact Termination Area Plating Thickness	1.27 μm [50 μin]
Wire Contact Termination Area Plating Material	Nickel



Wire Contact Termination Area Plating Material Finish	Matte
Contact Orientation	Straight
Contact Underplating Material	Nickel
Contact Underplating Material Thickness	1.27 µm[50 µin]

Termination Features

Termination Method to Wire & Cable	Crimp
------------------------------------	-------

Mechanical Attachment

Contact Retention Type Within Housing	Locking Lance
Connector Mounting Type	Cable Mount (Free-Hanging)
Wire Insulation Support	Without

Dimensions

Wire Size	3.31 – 5.26 mm ²
-----------	-----------------------------

Usage Conditions

Operating Temperature Range	-55 – 105 °C[-67 – 221 °F]
-----------------------------	----------------------------

Operation/Application

Circuit Application	Power
---------------------	-------

Industry Standards

CSA Rating	Certified
Glow Wire Rating	Standard Part - Not Glow Wire
VDE Tested	Yes
Agency/Standard	CSA, UL
CSA File Number	LR 7189
UL Rating	Recognized
UL File Number	E28476

Packaging Features

Packaging Method	Bag
Packaging Quantity	1000

Other

Wire/Cable Type	Discrete Wire
Wire Type	Stranded
For Use With	Universal MATE-N-LOK Plug or Cap Housing

Product Compliance

[For compliance documentation, visit the product page on TE.com>](#)

EU RoHS Directive 2011/65/EU	Compliant
EU ELV Directive 2000/53/EC	Compliant
China RoHS 2 Directive MIIT Order No 32, 2016	No Restricted Materials Above Threshold
EU REACH Regulation (EC) No. 1907/2006	Current ECHA Candidate List: JUNE 2022 (224) Candidate List Declared Against: JAN 2022 (223) SVHC > Threshold: Not Yet Reviewed
Halogen Content	Low Halogen - Br, Cl, F, I < 900 ppm per homogenous material. Also BFR/CFR/PVC Free
Solder Process Capability	Not applicable for solder process capability

Product Compliance Disclaimer

This information is provided based on reasonable inquiry of our suppliers and represents our current actual knowledge based on the information they provided. This information is subject to change. The part numbers that TE has identified as EU RoHS compliant have a maximum concentration of 0.1% by weight in homogenous materials for lead, hexavalent chromium, mercury, PBB, PBDE, DBP, BBP, DEHP, DIBP, and 0.01% for cadmium, or qualify for an exemption to these limits as defined in the Annexes of Directive 2011/65/EU (RoHS2). Finished electrical and electronic equipment products will be CE marked as required by Directive 2011/65/EU. Components may not be CE marked. Additionally, the part numbers that TE has identified as EU ELV compliant have a maximum concentration of 0.1% by weight in homogenous materials for lead, hexavalent chromium, and mercury, and 0.01% for cadmium, or qualify for an exemption to these limits as defined in the Annexes of Directive 2000/53/EC (ELV). Regarding the REACH Regulation, the information TE provides on SVHC in articles for this part number is based on the latest European Chemicals Agency (ECHA) 'Guidance on requirements for substances in articles' posted at this URL: <https://echa.europa.eu/guidance-documents/guidance-on-reach>



Compatible Parts

 <p>TE Part # 539972-1 EXTRACTION TOOL</p>	 <p>TE Part # 455830-1 INSERTION TOOL</p>	 <p>TE Part # 1-480705-2 06P UNML CAP HSG RED</p>	 <p>TE Part # 350784-1 15P UMNL CAP HSG</p>
---	--	--	--

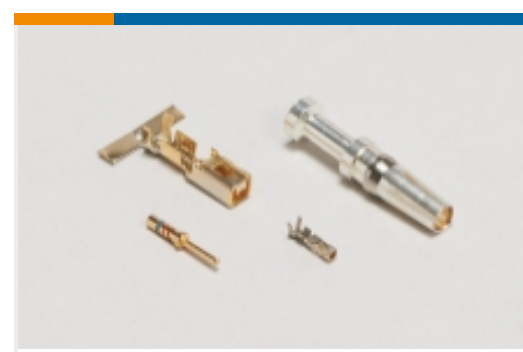

 <p>TE Part # 926307-3 6P UN-MNL AUFN-GEH</p>	 <p>TE Part # 1-480704-2 06P UMNL PLUG HSG RED</p>	 <p>TE Part # 926302-1 10& UNIV.M-N-L.PLUG</p>	 <p>TE Part # 1-350777-2 02P UMNL V0 PLUG HSG RED</p>
 <p>TE Part # 350783-1 12P UMNL CAP HSG</p>	 <p>TE Part # 1-350778-9 02P UMNL V0 CAP HSG BLACK</p>	 <p>TE Part # 350735-1 12P UMNL PLUG HSG</p>	 <p>TE Part # 926302-3 10P UN-MNL STECKGEH</p>
 <p>TE Part # 926308-3 8P UN-MNL AUFN-GEH</p>	 <p>TE Part # 350736-1 15P UMNL PLUG HSG</p>	 <p>TE Part # 1-480701-4 03P UMNL CAP HSG YELL</p>	 <p>TE Part # 640585-1 06P UMNL PLUG HSG V2 NATL</p>
 <p>TE Part # 926308-1 8P UNIV.M-N-L.CAP</p>	 <p>TE Part # 1-480703-9 04P UMNL CAP HSG BLK</p>	 <p>TE Part # 350720-1 09P UMNL PLUG HSG</p>	 <p>TE Part # 350810-1 05P UMNL CAP HSG</p>

Also in the Series | **Universal MATE-N-LOK**

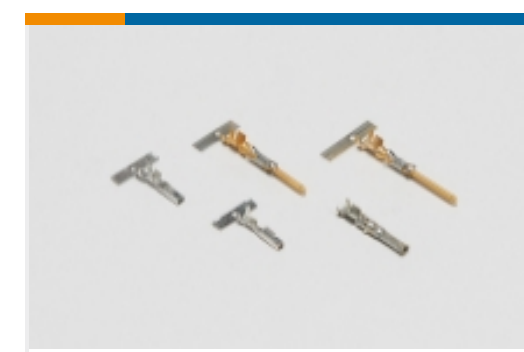
 <p>Circular Power Connectors(2)</p>	 <p>Connector Contacts(11)</p>	 <p>Insertion & Extraction Tools(4)</p>	 <p>Power Contacts(207)</p>
---	---	--	--

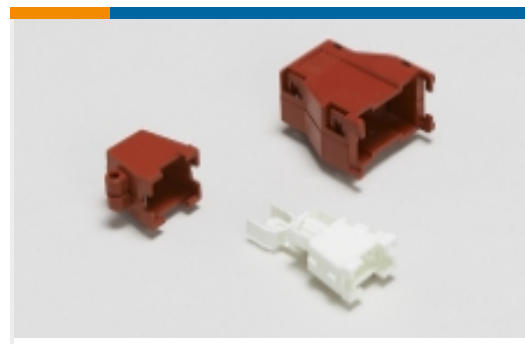

Rectangular Boots & Strain Relief(35)

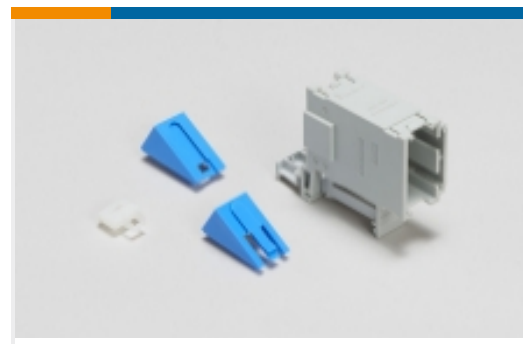

Rectangular Connector Adapters(7)

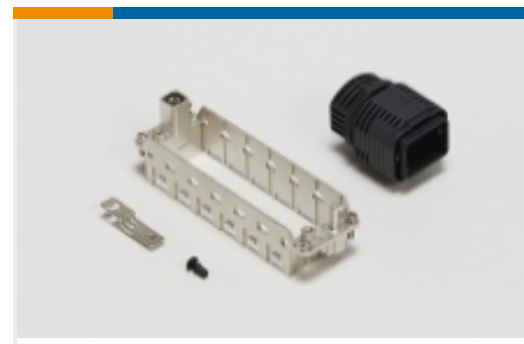

Rectangular Connector Hardware(1)



Rectangular Connector Housings(2)



Rectangular Connector Keying Plugs(3)



Rectangular Connector Locking(4)

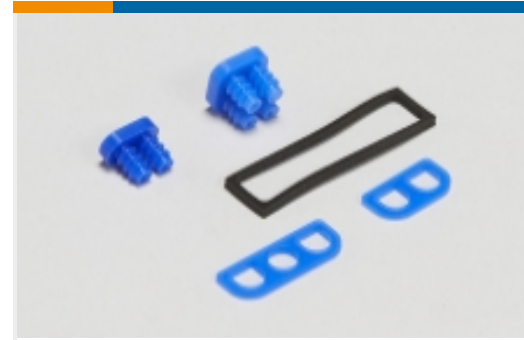

Rectangular Connector Seals(26)



Rectangular Power Connectors(729)

Customers Also Bought



TE Part #1658543-1
SOCKET CONT DUPL PLT LP HD-20



TE Part #6-1625966-5
HSA10 180R 5%



TE Part #205562-2
AMPLIMITE,ASY,PLUG,STD,109,4

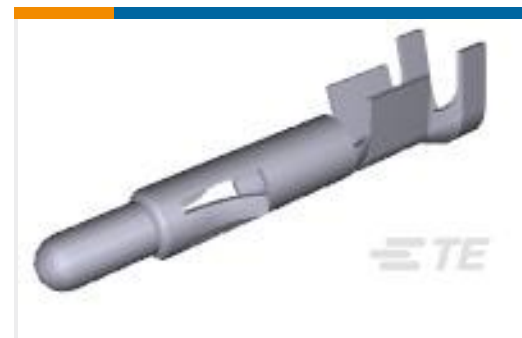

TE Part #350547-7
UMNL PIN 20-14 AUBR L/P



TE Part #350687-7
UMNL SPLIT PIN AUNI/BR



TE Part #61299-1
SPLICE 7000-12500 .031 TPST

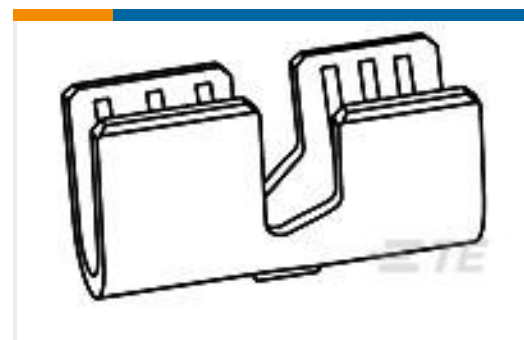

TE Part #61300-1
SPLICE IS 10000-16000 .031 TPST



TE Part #8-320560-1
TERMINAL,PIDG R 16-14 8

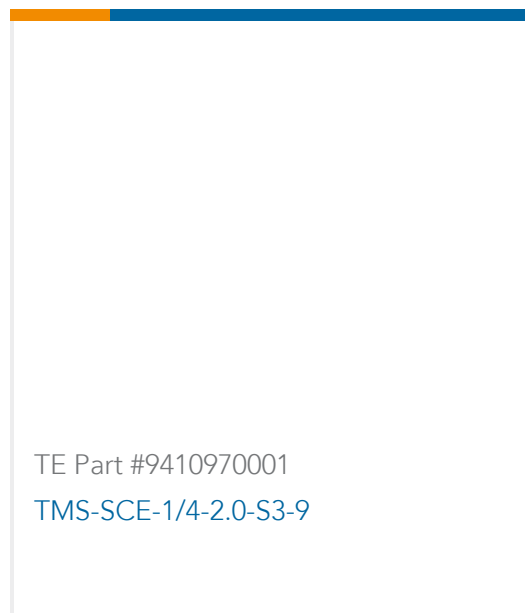

TE Part #9410970001
TMS-SCE-1/4-2.0-S3-9

Documents



Product Drawings

UMNL PIN 12-10 AU/PHBZ

English

CAD Files

3D PDF

3D

Customer View Model

[ENG_CVM_CVM_640309-6_C.2d_dxf.zip](#)

English

Customer View Model

[ENG_CVM_CVM_640309-6_C.3d_igs.zip](#)

English

Customer View Model

[ENG_CVM_CVM_640309-6_C.3d_stp.zip](#)

English

3D PDF

English

Customer View Model

[ENG_CVM_640309-6_J.2d_dxf.zip](#)

English

Customer View Model

[ENG_CVM_640309-6_J.3d_igs.zip](#)

English

Customer View Model

[ENG_CVM_640309-6_J.3d_stp.zip](#)

English

By downloading the CAD file I accept and agree to the [Terms and Conditions](#) of use.

Datasheets & Catalog Pages

SOFT_SHELL_PIN_SOCKET_CONNECTORS_STANDARD_DENSITY

English

Product Specifications

Application Specification

English

Instruction Sheets

Instruction Sheet (U.S.)

English

Agency Approvals

UL Report

English