

60583-2 ✓ ACTIVE

FASTON | FASTON 250

TE Internal #: 60583-2

Quick Disconnects, Receptacle, 12 – 10 AWG Wire Size, 3.31 – 5.26 mm<sup>2</sup> Wire Size, 9600 CMA Wire Size, Mating Tab Width .25 in [6.35 mm], FASTON 250

[View on TE.com >](#)



Terminals & Splices > Quick Disconnects

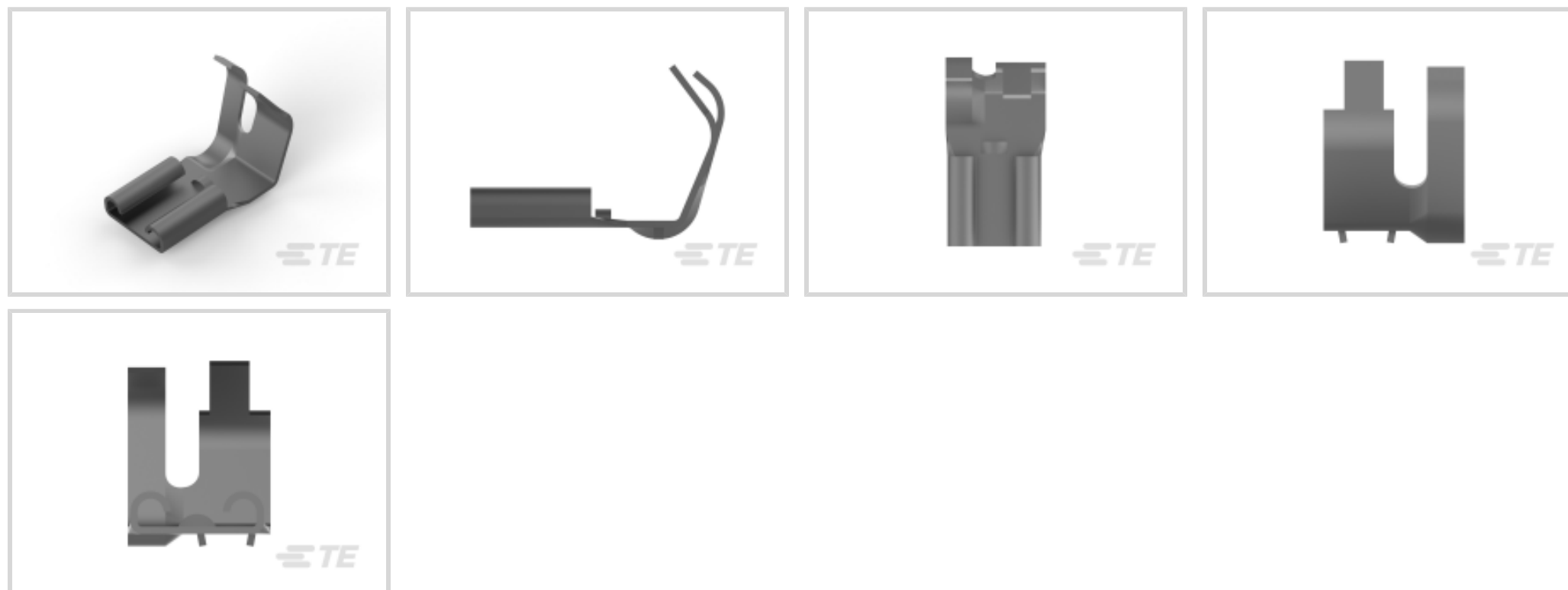

Quick Disconnect Terminal Type: **Receptacle**

Wire Size: **9600 CMA**

Mating Tab Width: **6.35 mm [ .25 in ]**

## Features

### Product Type Features

Terminates To	Wire & Cable
Wire Stop	No
Wire/Cable Type	Regular Wire
Insertion Force	Normal
Sealable	No

### Configuration Features

Connection Capacity	Single
---------------------	--------

### Contact Features

Quick Disconnect Terminal Type	Receptacle
Mating Tab Width	6.35 mm [.25 in]
Mating Tab Thickness	.81 mm [.032 in]
Terminal Orientation	Flag
Contact Base Material	Brass
Terminal Plating Material	Tin
Crimp Type	Tab-Lok



Barrel Type	Open
-------------	------

### Mechanical Attachment

Mating Retention Type	Dimple
Wire Insulation Support	With

### Dimensions

Accepts Wire Insulation Diameter Range	2.79 – 5.33 mm [.11 – .21 in]
Receptacle Terminal Stock Thickness	.46 mm [.018 in]
Wire Size	9600 CMA

### Usage Conditions

Insulation Option	Uninsulated
Operating Temperature Range	-40 – 110 °C [-40 – 230 °F]

### Packaging Features

Packaging Quantity	1000
Packaging Method	Loose Piece/Carton

### Other

Comment	Hermetic Terminals
---------	--------------------

## Product Compliance

[For compliance documentation, visit the product page on TE.com>](#)

EU RoHS Directive 2011/65/EU	Compliant
EU ELV Directive 2000/53/EC	Compliant
China RoHS 2 Directive MIIT Order No 32, 2016	No Restricted Materials Above Threshold
EU REACH Regulation (EC) No. 1907/2006	Current ECHA Candidate List: JUNE 2022 (224) Candidate List Declared Against: JAN 2022 (223) SVHC > Threshold: Not Yet Reviewed
Halogen Content	Low Halogen - Br, Cl, F, I < 900 ppm per homogenous material. Also BFR/CFR/PVC Free
Solder Process Capability	Not applicable for solder process capability

#### Product Compliance Disclaimer

This information is provided based on reasonable inquiry of our suppliers and represents our current actual knowledge based on the information they provided. This information is subject to change. The part numbers that TE has identified as

EU RoHS compliant have a maximum concentration of 0.1% by weight in homogenous materials for lead, hexavalent chromium, mercury, PBB, PBDE, DBP, BBP, DEHP, DIBP, and 0.01% for cadmium, or qualify for an exemption to these limits as defined in the Annexes of Directive 2011/65/EU (RoHS2). Finished electrical and electronic equipment products will be CE marked as required by Directive 2011/65/EU. Components may not be CE marked. Additionally, the part numbers that TE has identified as EU ELV compliant have a maximum concentration of 0.1% by weight in homogenous materials for lead, hexavalent chromium, and mercury, and 0.01% for cadmium, or qualify for an exemption to these limits as defined in the Annexes of Directive 2000/53/EC (ELV). Regarding the REACH Regulation, the information TE provides on SVHC in articles for this part number is based on the latest European Chemicals Agency (ECHA) 'Guidance on requirements for substances in articles' posted at this URL: <https://echa.europa.eu/guidance-documents/guidance-on-reach>

## Compatible Parts



TE Part # 60851-3  
250 FASTON REC 12-10 AWG TPBR



TE Part # 42232-3  
250 FASTON FLAG REC 18-12 AWG TPBR



TE Part # 41898  
250 FASTON FLAG REC 18-12 AWG TPBR



TE Part # 42015  
250 FASTON FLAG REC 18-12 AWG TPBZ



TE Part # 60583-1  
250 FASTON FLAG REC 12-10 AWG SPBZ

## Also in the Series | FASTON 250



Compression Connectors(4)

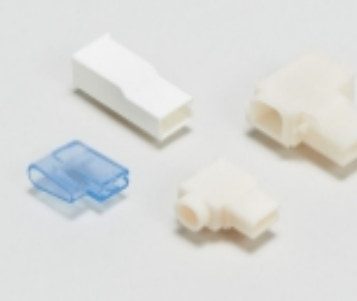

Crimp Terminal Housings(143)



Insertion & Extraction Tools(6)



Magnet Wire Terminals(1)



PCB Terminals(144)



Quick Disconnects(456)



Splices(4)

## Customers Also Bought



TE Part #5-826629-0  
50P AMPMODU II PIN HDR.



TE Part #3-794618-4  
04P MICRO MNL ASSY R/A HDR LF



TE Part #63688-1  
250 FASTON REC 18-14 AWG NPST



TE Part #2027395-3  
T9SV1K15-12S



TE Part #926209-6  
2X6P LOCK-CLIP GEH

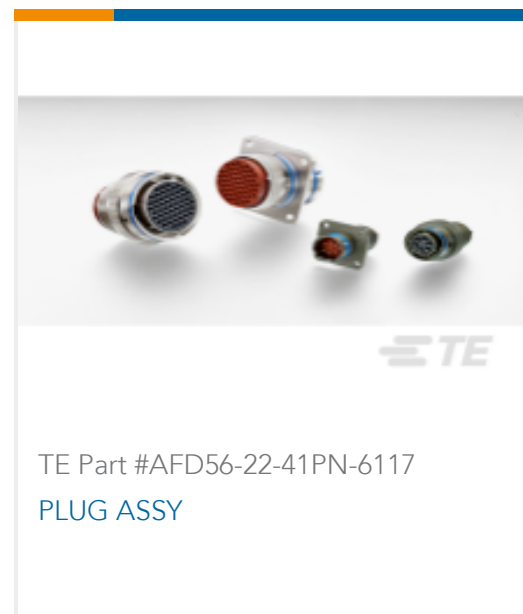

TE Part #AFD56-22-41PN-6117  
PLUG ASSY



TE Part #5-1634500-2  
BNC Str Plg Hex 50Ohm Nickel Pltd  
RG58C/



TE Part #5-1634513-1  
BNC LOW PROFILE ELBOW SOCKET  
50 OHMS



TE Part #60419-2  
250 FASTON FLAG REC 18-14 AWG  
TPBR

## Documents

### Product Drawings

[250 FASTON FLAG REC 12-10 AWG TPBR](#)

English

### CAD Files

Customer View Model

[ENG\\_CVM\\_CVM\\_60583-2\\_H.2d\\_dxf.zip](#)

English

[3D PDF](#)

3D

Customer View Model

[ENG\\_CVM\\_CVM\\_60583-2\\_H.3d\\_igs.zip](#)

English

Customer View Model

[ENG\\_CVM\\_CVM\\_60583-2\\_H.3d\\_stp.zip](#)

English

By downloading the CAD file I accept and agree to the [Terms and Conditions](#) of use.



## Product Specifications

### Engineering Report

English

---

## Agency Approvals

### UL Report

English