

638207-6 ✓ ACTIVE

Multilock Connector System

TE Internal #: 638207-6

Wire-to-Wire, 10 Position, .098 in [2.5 mm] Centerline, Gray, Signal,
Cable Mount (Free-Hanging), Multilock Connector System

[View on TE.com >](#)



Connectors > Automotive Connectors > Connector Housings > MULTILOCK, CONNECTOR HOUSING

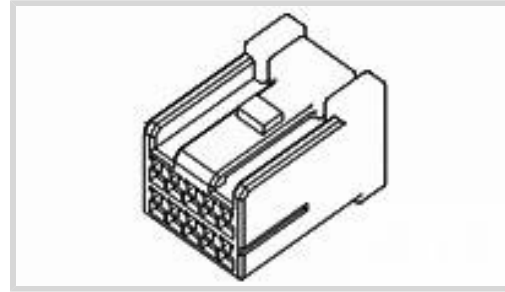

Mating Tab Width: 1 mm [.039 in]

Connector System: **Wire-to-Wire**

Number of Positions: 10

Centerline (Pitch): 2.5 mm [.098 in]

Sealable: No

[All MULTILOCK, CONNECTOR HOUSING \(576\)](#)

Features

Product Type Features

Connector & Housing Shape	Rectangular
Connector System	Wire-to-Wire
Sealable	No
Hybrid Connector	No

Configuration Features

Number of Positions	10
Number of Rows	2

Body Features

Body Material	PBT GF
Primary Product Color	Gray

Contact Features

Contact Size	1mm
Mating Tab Width	1 mm[.039 in]

Mechanical Attachment

Mounting Feature	Without
Terminal Position Assurance	No
Strain Relief	Without



Mating Alignment Type	Polarization Slot
Mating Alignment	With
Connector Mounting Type	Cable Mount (Free-Hanging)

Housing Features

Centerline (Pitch)	2.5 mm[.098 in]
--------------------	-----------------

Dimensions

Product Width	18.4 mm[.724 in]
Product Length	14 mm[.551 in]
Product Height	21 mm[.827 in]
Row-to-Row Spacing	5.2 mm[.205 in]

Usage Conditions

Operating Temperature (Max)	70 °C, 75 °C, 80 °C, 85 °C, 90 °C, 100 °C, 105 °C[158 °F][167 °F][176 °F][185 °F][194 °F][212 °F][221 °F]
Operating Temperature Range	-30 – 105 °C[-22 – 221 °F]

Operation/Application

Circuit Application	Signal
---------------------	--------

Packaging Features

Packaging Quantity	100
Packaging Method	Package

Other

Serviceable	No
Connector Position Assurance Capable	No

Product Compliance

[For compliance documentation, visit the product page on TE.com>](#)

EU RoHS Directive 2011/65/EU	Compliant
EU ELV Directive 2000/53/EC	Compliant
China RoHS 2 Directive MIIT Order No 32, 2016	No Restricted Materials Above Threshold
EU REACH Regulation (EC) No. 1907/2006	Current ECHA Candidate List: JUNE 2022 (224) Candidate List Declared Against: JUNE 2022 (224) Does not contain REACH SVHC

Halogen Content BFR/CFR/PVC Free, but Br/Cl >900 ppm in other sources.

Solder Process Capability Not applicable for solder process capability

Product Compliance Disclaimer

This information is provided based on reasonable inquiry of our suppliers and represents our current actual knowledge based on the information they provided. This information is subject to change. The part numbers that TE has identified as EU RoHS compliant have a maximum concentration of 0.1% by weight in homogenous materials for lead, hexavalent chromium, mercury, PBB, PBDE, DBP, BBP, DEHP, DIBP, and 0.01% for cadmium, or qualify for an exemption to these limits as defined in the Annexes of Directive 2011/65/EU (RoHS2). Finished electrical and electronic equipment products will be CE marked as required by Directive 2011/65/EU. Components may not be CE marked. Additionally, the part numbers that TE has identified as EU ELV compliant have a maximum concentration of 0.1% by weight in homogenous materials for lead, hexavalent chromium, and mercury, and 0.01% for cadmium, or qualify for an exemption to these limits as defined in the Annexes of Directive 2000/53/EC (ELV). Regarding the REACH Regulation, the information TE provides on SVHC in articles for this part number is based on the latest European Chemicals Agency (ECHA) 'Guidance on requirements for substances in articles' posted at this URL: <https://echa.europa.eu/guidance-documents/guidance-on-reach>

Compatible Parts



TE Part # CAT-M9194-T273
MULTILOCK, RECEPTACLE AND TAB



TE Part # 9-1438743-6
54way Hyb .040/2.8 Tails Down Cap Assy



TE Part # CAT-SIGH262
SIGNAL HEADER

Also in the Series | Multilock Connector System



Automotive Connector Caps & Covers (16)



Automotive Connector EMC Shielding (1)

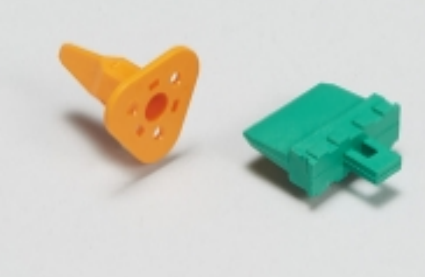

Automotive Connector Locks & Position Assurance(2)



Automotive Housings(575)



Automotive Seals & Cavity Plugs(2)

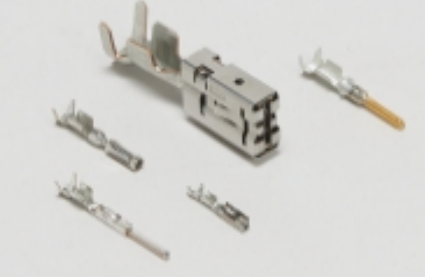

Automotive Terminals(140)



Insertion & Extraction Tools(6)



Other Automotive Connector Accessories(9)



PCB Headers & Receptacles(129)

Customers Also Bought

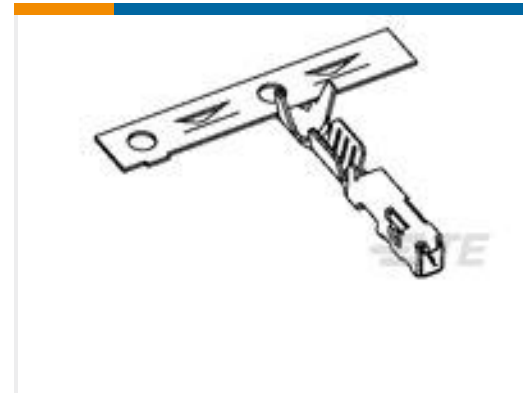
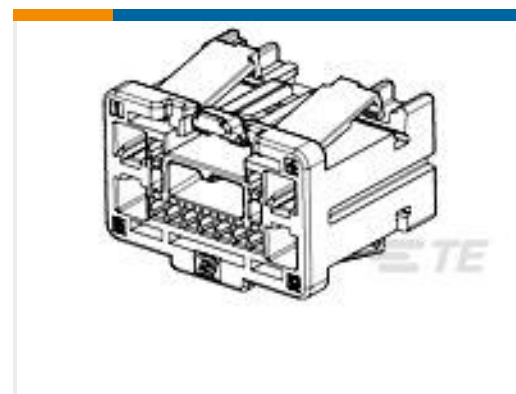
TE Part #1-1718644-1
3POS, MCON 1.2 LL REC SEALEDTE Part #1924955-1
CONTACT,FEMALE0.64,20-22AWG,
UNSEALTE Part #175266-2
MULTILOCK, RECEPTACLE AND TABTE Part #917989-6
MULTILOCK, CONNECTOR HOUSINGTE Part #6-1438912-0
JACK KIT, UNASSEM, 180 DEG,RG-
174, FakraTE Part #776001-1
RECP TERNIAL 1.5MM OBD CONNTE Part #1924667-1
13p Hybrid - 1pc Unsealed Plug, Key ATE Part #1438761-6
22WAY HYBRID .040/2.8 PLUG ASSY
KEY'A'

Documents

Product Drawings

040 10P PLUG ASSY III GY

English

CAD Files

Customer View Model

[ENG_CVM_CVM_638207-6_G.2d_dxf.zip](#)

English

3D PDF

3D

Customer View Model

[ENG_CVM_CVM_638207-6_G.3d_igs.zip](#)

English

Customer View Model

[ENG_CVM_CVM_638207-6_G.3d_stp.zip](#)

English

By downloading the CAD file I accept and agree to the [Terms and Conditions](#) of use.



Datasheets & Catalog Pages

MULTILOCK Connector System

English

Product Specifications

Product Specification

Japanese

Product Environmental Compliance

Product Compliance

English

Product Compliance

English