

63862-1 ✓ ACTIVE

FASTON | FASTON 250

TE Internal #: 63862-1

PCB Terminals, Tab, Mating Tab Width 6.35 mm [.25 in], PCB Hole Diameter 1.32 mm [.052 in], Through Hole - Solder, Tin Plating, Brass, FASTON 250

[View on TE.com >](#)



Terminals & Splices > PCB Terminals

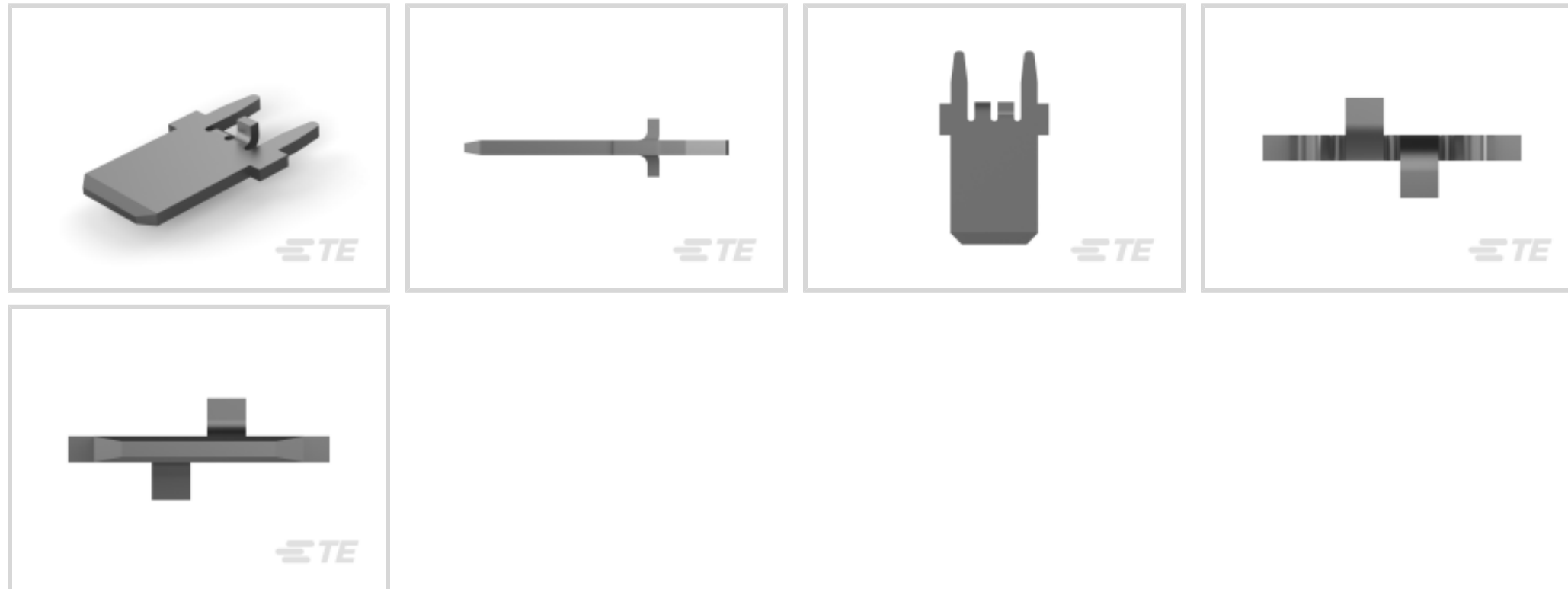

PCB Terminal Type: **Tab**

PCB Thickness (Recommended): 1.57 – 2.36 mm [.062 – .093 in]

Mating Tab Width: 6.35 mm [.25 in]

Mating Tab Thickness: .81 mm [.032 in]

PCB Hole Diameter: 1.32 mm [.052 in]

Features

Configuration Features

Stud Hole	No
Terminal Angle	180 °

Contact Features

Contact Plating Material	Tin
PCB Terminal Type	Tab
Mating Tab Width	6.35 mm [.25 in]
Mating Tab Thickness	.81 mm [.032 in]
Terminal Plating Material	Tin
Contact Underplating Material	Brass
Terminal Size	6.35
Terminal Orientation	Straight

Termination Features

Termination Method to Printed Circuit Board	Through Hole - Solder
Product Terminates To	Printed Circuit Board

Mechanical Attachment

Wire Insulation Support	With
-------------------------	------

Dimensions

Extension Below Board	3.81 mm[.15 in]
Receptacle Terminal Stock Thickness	.81 mm[.032 in]
PCB Thickness (Recommended)	1.57 – 2.36 mm[.062 – .093 in]
PCB Hole Diameter	1.32 mm[.052 in]
Profile Height from PCB	10.21 mm[.402 in]

Usage Conditions

Insulation Option	Uninsulated
Operating Temperature Range	-30 – 110 °C[-22 – 230 °F]

Packaging Features

Packaging Quantity	10000
Packaging Method	Reel

Other

Comment	Insertion equipment available.
---------	--------------------------------

Product Compliance

[For compliance documentation, visit the product page on TE.com>](#)









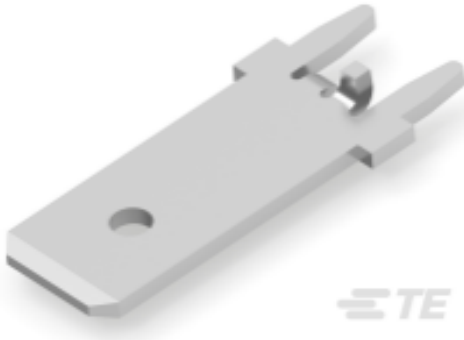

EU RoHS Directive 2011/65/EU	Compliant
EU ELV Directive 2000/53/EC	Compliant
China RoHS 2 Directive MIIT Order No 32, 2016	No Restricted Materials Above Threshold
EU REACH Regulation (EC) No. 1907/2006	Current ECHA Candidate List: JUNE 2022 (224) Candidate List Declared Against: JAN 2022 (223) SVHC > Threshold: Not Yet Reviewed
Halogen Content	Low Halogen - Br, Cl, F, I < 900 ppm per homogenous material. Also BFR/CFR/PVC Free
Solder Process Capability	Wave solder capable to 265°C

Product Compliance Disclaimer

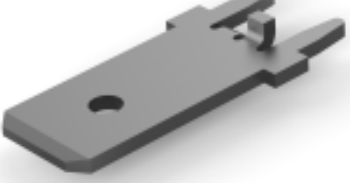

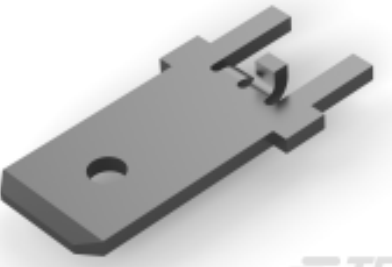

This information is provided based on reasonable inquiry of our suppliers and represents our current actual knowledge based on the information they provided. This information is subject to change. The part numbers that TE has identified as

EU RoHS compliant have a maximum concentration of 0.1% by weight in homogenous materials for lead, hexavalent chromium, mercury, PBB, PBDE, DBP, BBP, DEHP, DIBP, and 0.01% for cadmium, or qualify for an exemption to these limits as defined in the Annexes of Directive 2011/65/EU (RoHS2). Finished electrical and electronic equipment products will be CE marked as required by Directive 2011/65/EU. Components may not be CE marked. Additionally, the part numbers that TE has identified as EU ELV compliant have a maximum concentration of 0.1% by weight in homogenous materials for lead, hexavalent chromium, and mercury, and 0.01% for cadmium, or qualify for an exemption to these limits as defined in the Annexes of Directive 2000/53/EC (ELV). Regarding the REACH Regulation, the information TE provides on SVHC in articles for this part number is based on the latest European Chemicals Agency (ECHA) 'Guidance on requirements for substances in articles' posted at this URL: <https://echa.europa.eu/guidance-documents/guidance-on-reach>

Compatible Parts

 <p>TE Part # 1217861-1 250 FASTON,PCB TAB,TCBR</p>	 <p>TE Part # 1217133-1 187 FASTON,PCB TAB,TNBR</p>	 <p>TE Part # 63986-1 250 FASTON TAB TPBR</p>	 <p>TE Part # 1217127-1 250 FASTON,PCB TAB,TPBR</p>
 <p>TE Part # 1217566-1 250 FASTON,PCB TAB,TCBR</p>	 <p>TE Part # 1217125-1 250 FASTON,PCB TAB,TPBR</p>	 <p>TE Part # 1742361-1 187 FASTON,PCB TAB,TPBR</p>	 <p>TE Part # 1217566-2 250 FASTON,PCB TAB,TCBR</p>
 <p>TE Part # 63824-1 250 FASTON TAB TPBR</p>	 <p>TE Part # 1217126-1 250 FASTON,PCB TAB,TPBR</p>	 <p>TE Part # 1217539-1 250 FASTON,PCB TAB,TCBR</p>	

Also in the Series | FASTON 250

 <p>Compression Connectors(4)</p>	 <p>Crimp Terminal Housings(143)</p>	 <p>Insertion & Extraction Tools(6)</p>	 <p>Magnet Wire Terminals(1)</p>
--	---	--	---



PCB Terminals(144)

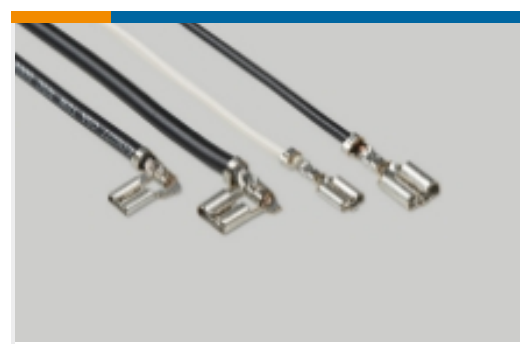

Quick Disconnects(456)



Splices(4)

Customers Also Bought

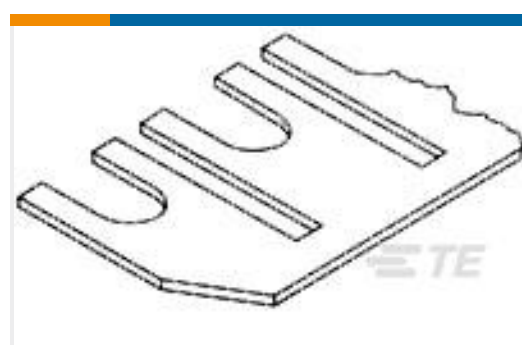
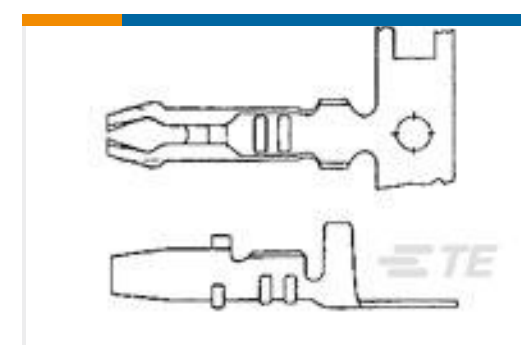
TE Part #6-1415055-1
SR4D4048TE Part #1879378-9
Metal Chip Resistor: Current SenseTE Part #643423-1
06P UMNL HDR ASSY POLTE Part #643495-1
05P MTA156 HDR ASSY W/O#4TE Part #5-1437644-4
J8-2=J8-XX JUMPERTE Part #63951-4
250 FASTON TAB TPBRTE Part #8-1462000-5
C93450=MT RELAY 550 MW 5 VTE Part #170072-1
AMP-IN 24-20 AWG

Documents

Product Drawings

250 FASTON TAB TPBR

English

CAD Files

3D PDF

3D

Customer View Model

[ENG_CVM_CVM_63862-1_R_c-63862-1-r.2d_dxf.zip](#)

English

Customer View Model

[ENG_CVM_CVM_63862-1_R_c-63862-1-r.3d_igs.zip](#)

English

Customer View Model

[ENG_CVM_CVM_63862-1_R_c-63862-1-r.3d_stp.zip](#)

English

By downloading the CAD file I accept and agree to the [Terms and Conditions](#) of use.



Datasheets & Catalog Pages

[FASTON PCB Tabs and Receptacles](#)

English

[PRINTED CIRCUIT BOARD TERMINALS AND DISCONNECTS](#)

English

Product Specifications

[Application Specification](#)

English

[Application Specification](#)

English

Product Environmental Compliance

[MD_63862-1_10262018658_dmtec](#)

English

[MD_63862-1_10262018658_dmtec](#)

English

Agency Approvals

[CSA Certificate](#)

English

[CSA Certificate](#)

English