

60529-1 ✓ ACTIVE

FASTON 187

TE Internal #: 60529-1

TE Internal Description: 187 FASTON REC 20-16 AWG BR

[View on TE.com >](#)

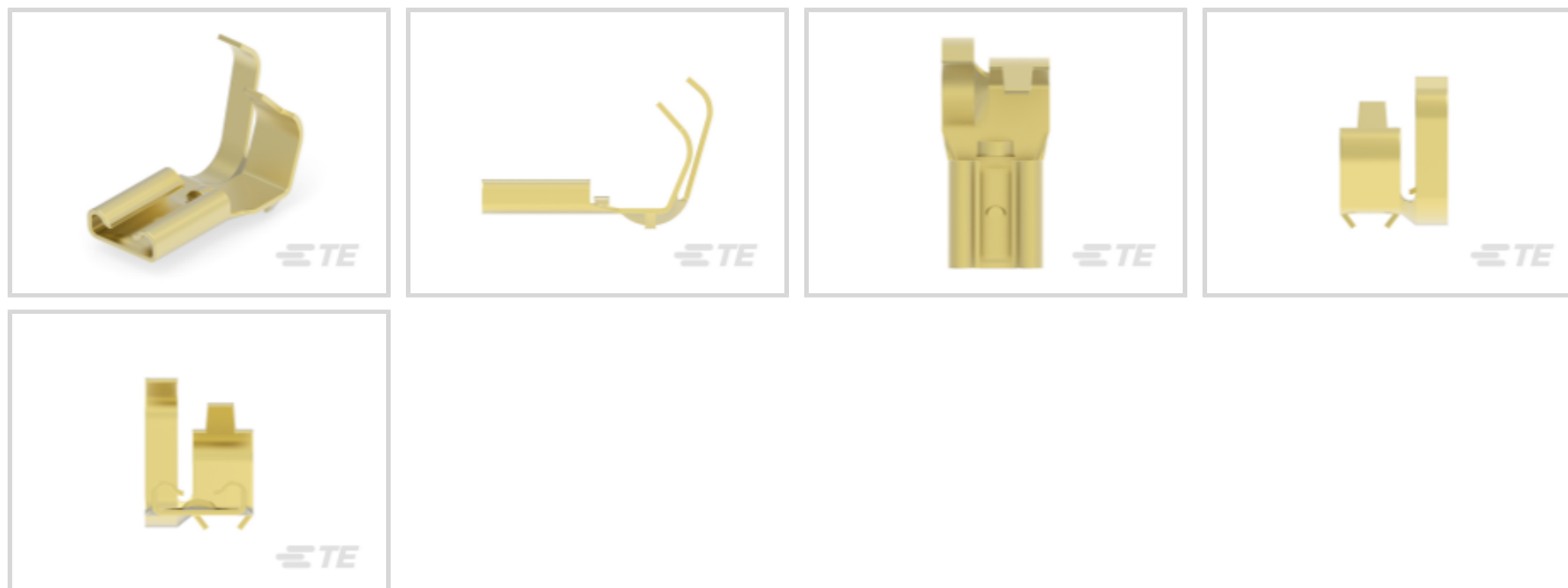

### Product Compliance

[For compliance documentation, visit the product page on TE.com>](#)

EU RoHS Directive 2011/65/EU	Compliant
EU ELV Directive 2000/53/EC	Compliant
China RoHS 2 Directive MIIT Order No 32, 2016	No Restricted Materials Above Threshold
EU REACH Regulation (EC) No. 1907/2006	Current ECHA Candidate List: JUNE 2022 (224) Candidate List Declared Against: JAN 2021 (211) SVHC > Threshold: Not Yet Reviewed
Halogen Content	Low Halogen - Br, Cl, F, I < 900 ppm per homogenous material. Also BFR/CFR/PVC Free
Solder Process Capability	Not applicable for solder process capability

#### Product Compliance Disclaimer

This information is provided based on reasonable inquiry of our suppliers and represents our current actual knowledge based on the information they provided. This information is subject to change. The part numbers that TE has identified as EU RoHS compliant have a maximum concentration of 0.1% by weight in homogenous materials for lead, hexavalent chromium, mercury, PBB, PBDE, DBP, BBP, DEHP, DIBP, and 0.01% for cadmium, or qualify for an exemption to these limits as defined in the Annexes of Directive 2011/65/EU (RoHS2). Finished electrical and electronic equipment products will be CE marked as required by Directive 2011/65/EU. Components may not be CE marked. Additionally, the part numbers that TE has identified as EU ELV compliant have a maximum concentration of 0.1% by weight in homogenous materials for lead, hexavalent chromium, and mercury, and 0.01% for cadmium, or qualify for an exemption to these limits as defined in the Annexes of Directive 2000/53/EC (ELV). Regarding the REACH Regulation, the information TE provides on SVHC in articles for this part number is based on the latest European Chemicals Agency (ECHA) 'Guidance on requirements for substances in articles' posted at this URL: <https://echa.europa.eu/guidance-documents/guidance-on-reach>

### Compatible Parts



### Also in the Series | FASTON 187

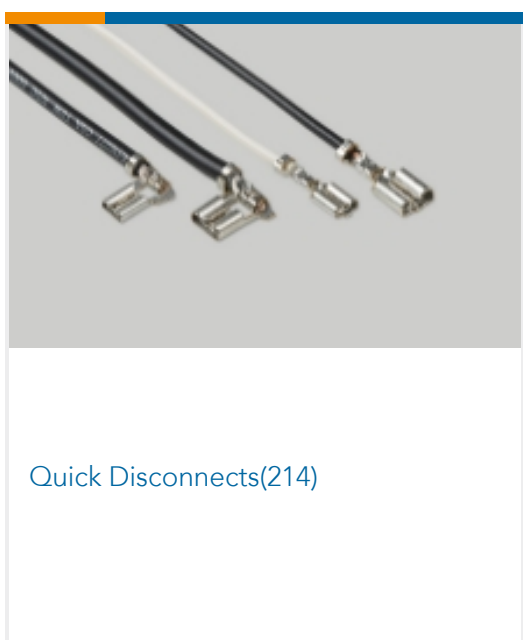
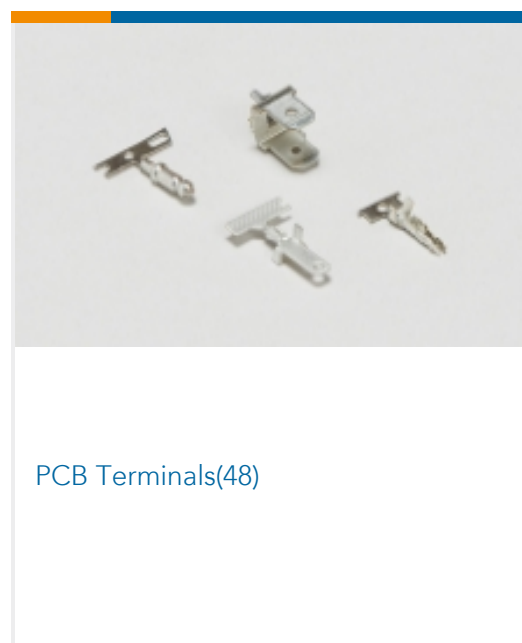
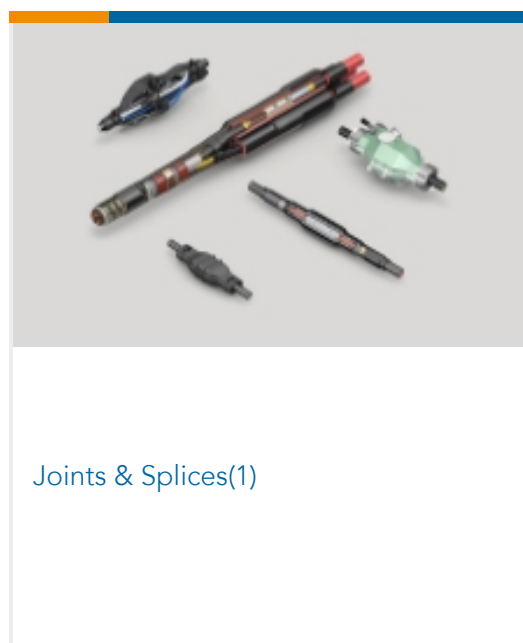
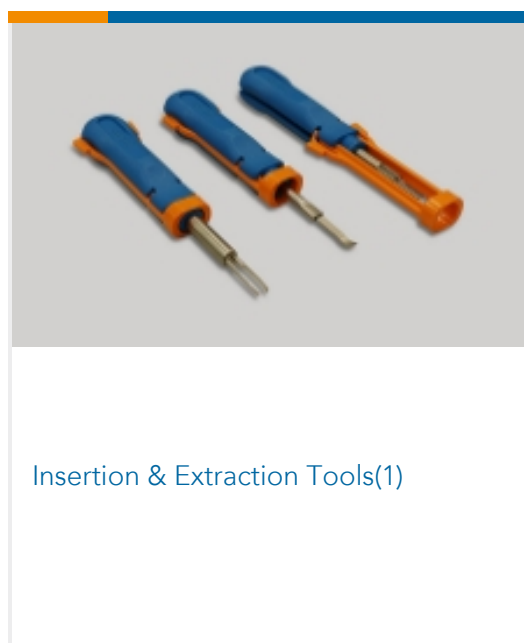
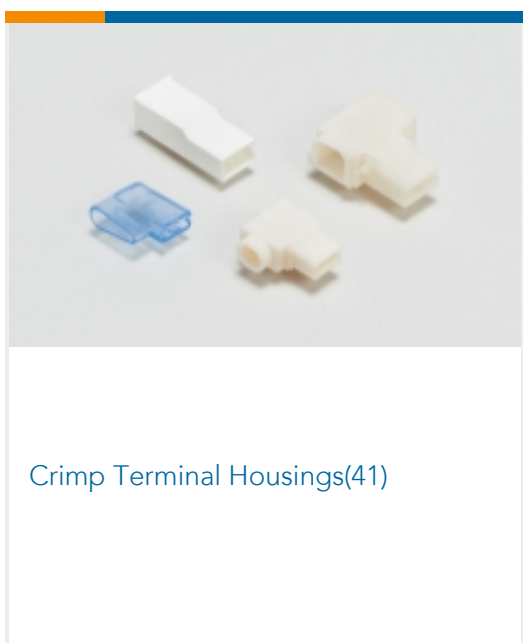

### Customers Also Bought



TE Part #7-1971875-7  
PTL 3X5 CAP PANEL MT HITEMP KEY  
C BLK

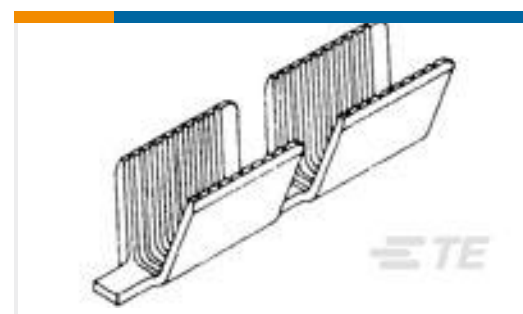

TE Part #62306-2  
AMVAR SPLC 1500-5000 020TPBR



TE Part #7-2232263-3  
POWER TRIPLE LOCK: Glow Wire Cap



TE Part #7-2232265-3  
POWER TRIPLE LOCK GLOW WIRE  
PLUG



TE Part #1744493-3  
03P EP-II HOUSING, ORANGE



TE Part #2327576-1  
06P SL156 HSG NO3P THRU BD LTH  
UL94V0



TE Part #336076-5  
250 FASTON,E SPRING REC.,17-14  
AWG,PNST



TE Part #2217043-1  
CPU BOARD ASSEMBLY

## Documents

### Product Drawings

#### 187 FASTON REC 20-16 AWG BR

English

### CAD Files

#### Customer View Model

[ENG\\_CVM\\_CVM\\_60529-1\\_V.2d\\_dxf.zip](#)

English

#### 3D PDF

3D

#### Customer View Model

[ENG\\_CVM\\_CVM\\_60529-1\\_V.3d\\_igs.zip](#)

English

#### Customer View Model

[ENG\\_CVM\\_CVM\\_60529-1\\_V.3d\\_stp.zip](#)

English

By downloading the CAD file I accept and agree to the [Terms and Conditions](#) of use.

### Datasheets & Catalog Pages

#### 82004 FASTON Terminals (Insulated and Uninsulated) Catalog - FASTON Receptacles Section

English

### Product Specifications

#### Product Specification

English

### Product Environmental Compliance

[MD\\_60529-1\\_062920151229\\_dmtec](#)



English

[MD\\_60529-1\\_062920151229\\_dmtec](#)

English