

638078-1 ✓ ACTIVE

AMP | AMPSEAL 16

TE Internal #: 638078-1

Automotive Terminals, Pin, Pin Diameter .063 in [1.59 mm], 18 – 14 AWG Wire Size, .8 – 2 mm² Wire Size, Gold (Au) Interface Plating, AMPSEAL 16

[View on TE.com >](#)



Terminals & Splices > Automotive Terminals > Contacts: Size 16, 13A



Terminal Type: Pin

Mating Pin Diameter: 1.59 mm [.063 in]

Terminal Transmits: 0 – 24 A (Low Power)

Wire Size: .8 – 2 mm²

[All Contacts: Size 16, 13A \(33\)](#)

Features

Product Type Features

Sealable	No
----------	----

Contact Features

Contact Size	Size 16
--------------	---------

Contact Fabrication	Stamped & Formed
---------------------	------------------

Typical Current Rating	13 A
------------------------	------

Crimp Type	F-Crimp
------------	---------

Terminal Type	Pin
---------------	-----

Mating Pin Diameter	1.59 mm [.063 in]
---------------------	-------------------

Interface Plating	Gold (Au)
-------------------	-----------

Contact Termination Area Plating Material	Tin (Sn)
---	----------

Termination Features

Termination Method to Wire & Cable	Crimp
------------------------------------	-------

Product Terminates To	Wire
-----------------------	------

Dimensions

Wire Size	.8 – 2 mm ²
-----------	------------------------

Wire Size Search	14 AWG, 15 AWG, 16 AWG, 17 AWG, 18 AWG
------------------	--



Wire Insulation Diameter	2.26 – 3.32 mm [.089 – .131 in]
--------------------------	---------------------------------

Usage Conditions

Insulation Option	Uninsulated
Operating Temperature (Max)	80 °C, 85 °C, 90 °C, 100 °C, 105 °C, 110 °C, 120 °C [176 °F][185 °F][194 °F][212 °F][221 °F][230 °F][248 °F]
Operating Temperature Range	-40 – 120 °C [-40 – 248 °F]

Operation/Application

Compatible With Wire Base Material	Copper
------------------------------------	--------

Packaging Features

Packaging Method	Reel
Packaging Quantity	4000

Other

Customer Preferred Contact	No
Terminal Transmits	0 – 24 A (Low Power)

Product Compliance

[For compliance documentation, visit the product page on TE.com>](#)

EU RoHS Directive 2011/65/EU	Compliant
EU ELV Directive 2000/53/EC	Compliant
China RoHS 2 Directive MIIT Order No 32, 2016	No Restricted Materials Above Threshold
EU REACH Regulation (EC) No. 1907/2006	Current ECHA Candidate List: JUNE 2022 (224) Candidate List Declared Against: JAN 2022 (223) SVHC > Threshold: Not Yet Reviewed
Halogen Content	Low Halogen - Br, Cl, F, I < 900 ppm per homogenous material. Also BFR/CFR/PVC Free
Solder Process Capability	Not applicable for solder process capability

Product Compliance Disclaimer

This information is provided based on reasonable inquiry of our suppliers and represents our current actual knowledge based on the information they provided. This information is subject to change. The part numbers that TE has identified as EU RoHS compliant have a maximum concentration of 0.1% by weight in homogenous materials for lead, hexavalent chromium, mercury, PBB, PBDE, DBP, BBP, DEHP, DIBP, and 0.01% for cadmium, or qualify for an exemption to these limits as defined in the Annexes of Directive 2011/65/EU (RoHS2). Finished electrical and electronic equipment products will be CE marked as required by Directive 2011/65/EU. Components may not be CE marked. Additionally, the part

numbers that TE has identified as EU ELV compliant have a maximum concentration of 0.1% by weight in homogenous materials for lead, hexavalent chromium, and mercury, and 0.01% for cadmium, or qualify for an exemption to these limits as defined in the Annexes of Directive 2000/53/EC (ELV). Regarding the REACH Regulation, the information TE provides on SVHC in articles for this part number is based on the latest European Chemicals Agency (ECHA) 'Guidance on requirements for substances in articles' posted at this URL: <https://echa.europa.eu/guidance-documents/guidance-on-reach>

Compatible Parts

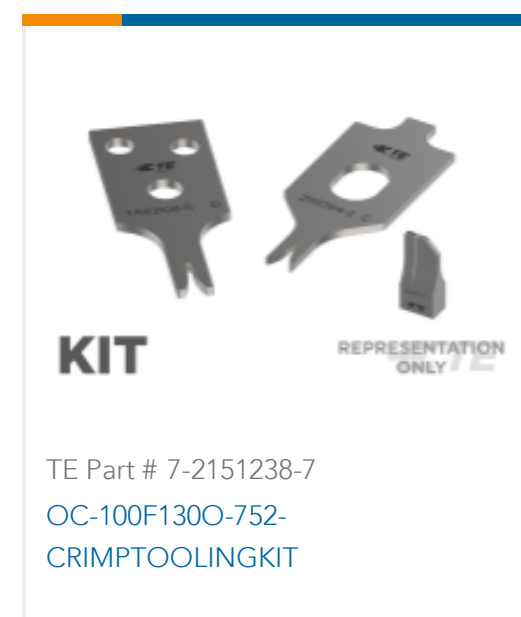
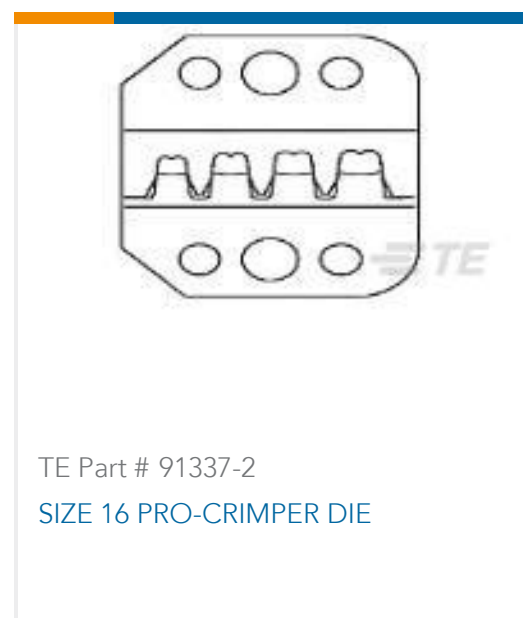



Also in the Series | AMPSEAL 16

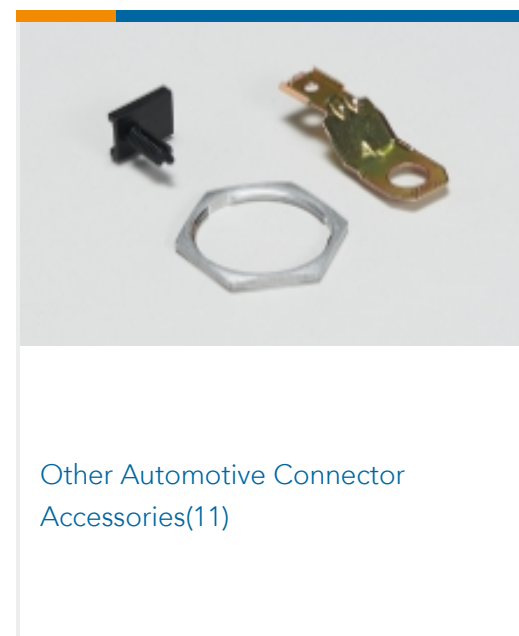
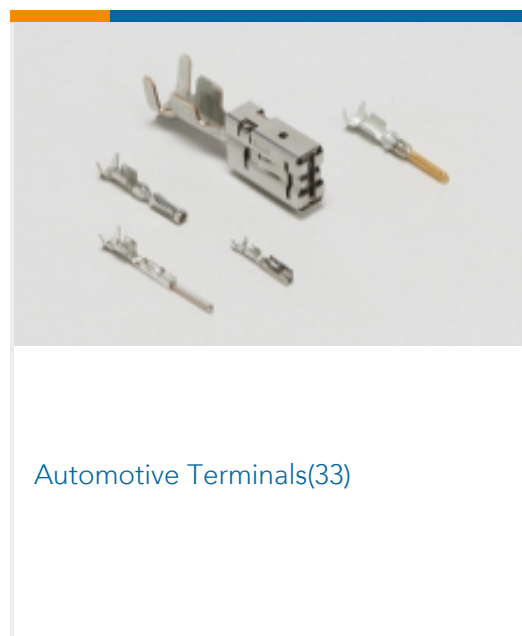
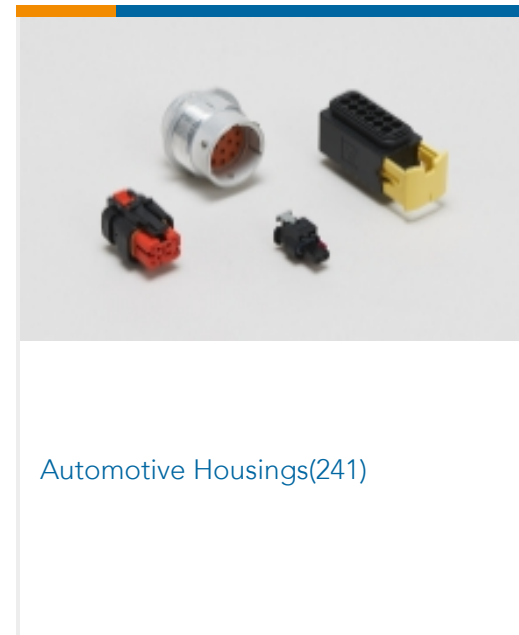
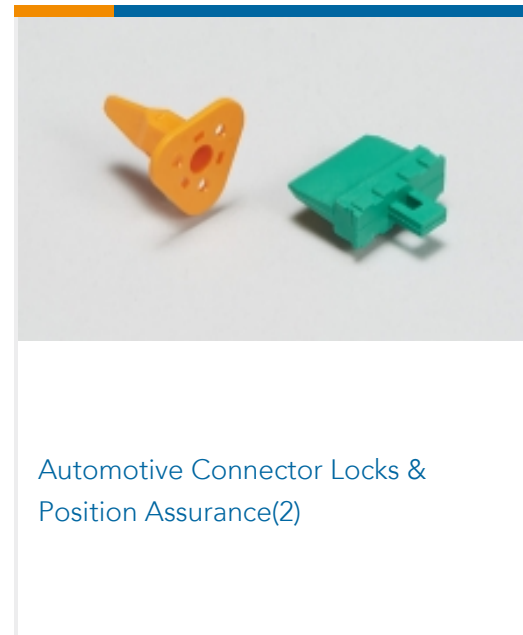
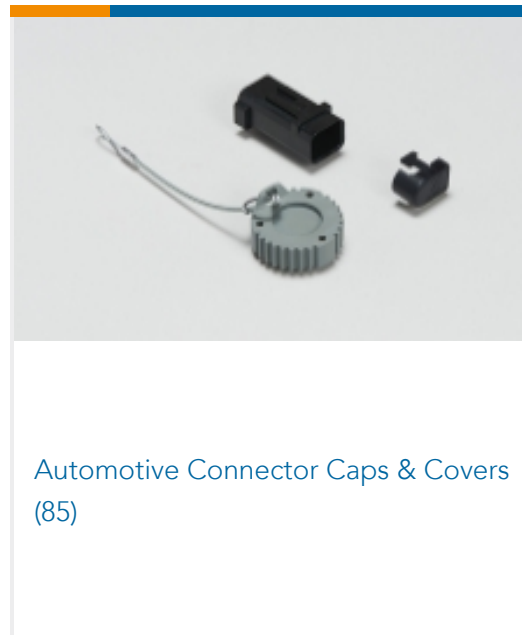

Customers Also Bought

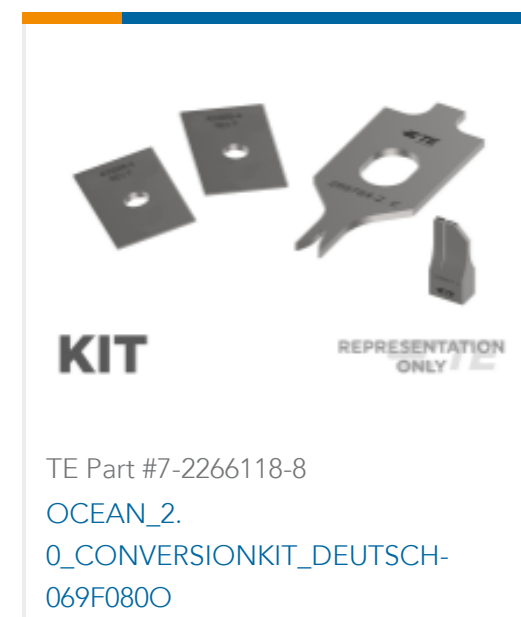
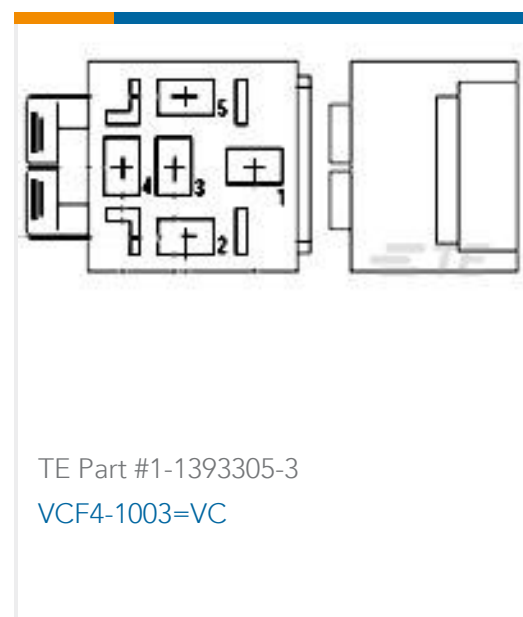



Documents

Product Drawings

[PIN, SF, SIZE 16, 14-18 AWG, AU/SN](#)

English

CAD Files

Customer View Model

[ENG_CVM_638078-1_E1.3d_igs.zip](#)

English

Customer View Model

[ENG_CVM_638078-1_E1.3d_stp.zip](#)

English

Customer View Model

[ENG_CVM_638078-1_E1.2d_dxf.zip](#)

English

[3D PDF](#)

English

By downloading the CAD file I accept and agree to the [Terms and Conditions](#) of use.

Datasheets & Catalog Pages

[ICT Terminals and Connectors Catalogue](#)

English

[CONNECTOR SELECTOR](#)

English

Product Specifications

[Application Specification](#)

English

Product Environmental Compliance

[MD_638078-1_10302017022_dmtec](#)

English

[MD_638078-1_10302017022_dmtec](#)

English