

63969-1 ✓ ACTIVE

FASTON | FASTON 205

TE Internal #: 63969-1

PCB Terminals, Receptacle, Mating Tab Width 6.35 mm / 5.21 mm [.25 in / .205 in], PCB Hole Diameter 1.4 mm [.055 in], FASTON 205

[View on TE.com >](#)



Terminals & Splices > PCB Terminals

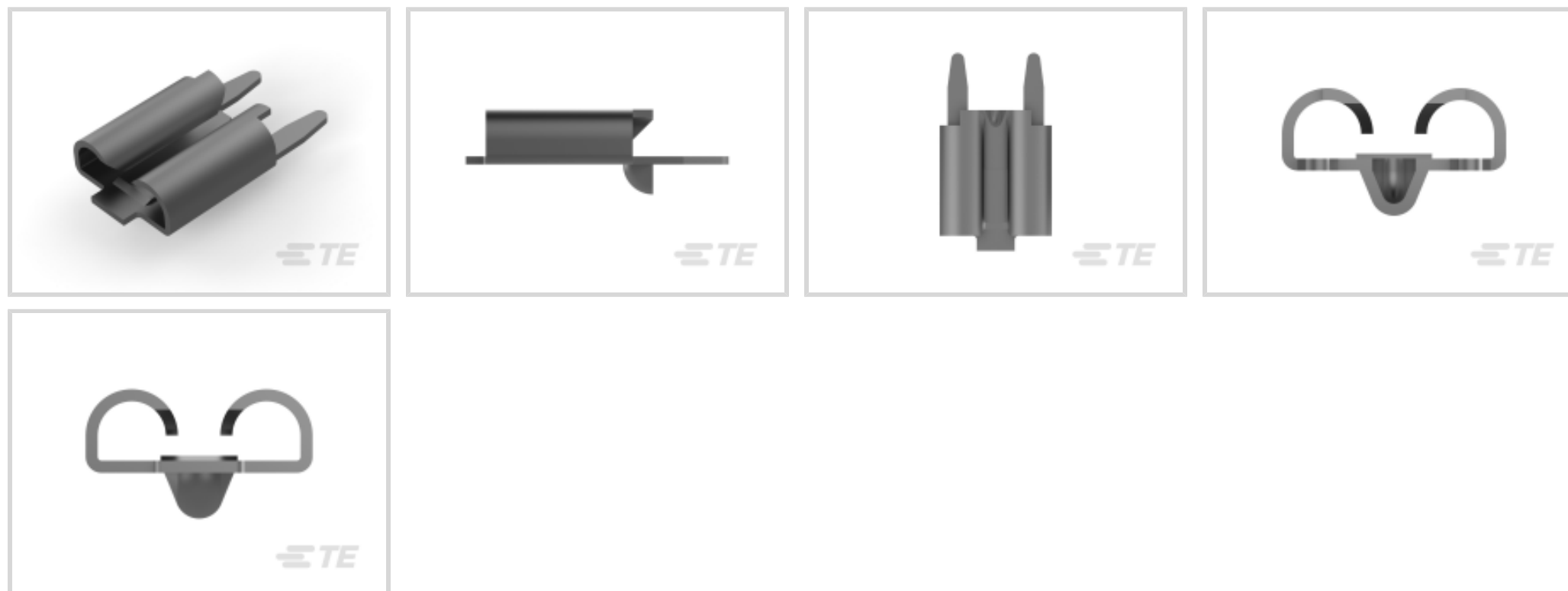

PCB Terminal Type: **Receptacle**

PCB Thickness (Recommended): 1.57 mm [.062 in]

Mating Tab Width: 5.21 mm, 6.35 mm [.205 in, .25 in]

Mating Tab Thickness: .64 mm, .8 mm [.025 in, .031 in]

PCB Hole Diameter: 1.4 mm [.055 in]

Features

Product Type Features

Insertion Force	Low
-----------------	-----

Configuration Features

Connection Capacity	Single
---------------------	--------

Stud Hole	No
-----------	----

Terminal Angle	180 °
----------------	-------

Body Features

Plating Thickness	2.54 µm[100 µin]
-------------------	------------------

Contact Features

Contact Plating Material	Tin
--------------------------	-----

PCB Terminal Type	Receptacle
-------------------	------------

Mating Tab Width	5.21 mm, 6.35 mm[.205 in][.25 in]
------------------	-----------------------------------

Mating Tab Thickness	.64 mm, .8 mm[.025 in][.031 in]
----------------------	---------------------------------

Terminal Plating Material	Tin
---------------------------	-----

Contact Underplating Material	Copper, Nickel
-------------------------------	----------------



Terminal Size	5.2, 6.35
---------------	-----------

Terminal Orientation	Straight
----------------------	----------

Termination Features

Termination Method to Printed Circuit Board	Through Hole - Solder
---	-----------------------

Product Terminates To	Printed Circuit Board
-----------------------	-----------------------

Mechanical Attachment

Wire Insulation Support	Without
-------------------------	---------

Dimensions

Extension Below Board	3.81 mm[.15 in]
-----------------------	-----------------

Receptacle Terminal Stock Thickness	.41 mm[.016 in]
-------------------------------------	-----------------

PCB Thickness (Recommended)	1.57 mm[.062 in]
-----------------------------	------------------

PCB Hole Diameter	1.4 mm[.055 in]
-------------------	-----------------

Profile Height from PCB	8.38 mm[.334 in]
-------------------------	------------------

Usage Conditions

Insulation Option	Uninsulated
-------------------	-------------

Operating Temperature Range	-40 – 105 °C[-40 – 221 °F]
-----------------------------	----------------------------

Packaging Features

Packaging Quantity	2800
--------------------	------

Packaging Method	Reel
------------------	------

Other

Line	Budget
------	--------

Product Compliance

[For compliance documentation, visit the product page on TE.com>](#)

EU RoHS Directive 2011/65/EU	Compliant
------------------------------	-----------

EU ELV Directive 2000/53/EC	Compliant
-----------------------------	-----------

China RoHS 2 Directive MIIT Order No 32, 2016	No Restricted Materials Above Threshold
---	---

EU REACH Regulation (EC) No. 1907/2006	Current ECHA Candidate List: JUNE 2022 (224) Candidate List Declared Against: JAN 2022 (223) SVHC > Threshold: Not Yet Reviewed
--	--

Halogen Content	Low Halogen - Br, Cl, F, I < 900 ppm per
-----------------	--

homogenous material. Also BFR/CFR/PVC Free

Solder Process Capability

Wave solder capable to 240°C

Product Compliance Disclaimer

This information is provided based on reasonable inquiry of our suppliers and represents our current actual knowledge based on the information they provided. This information is subject to change. The part numbers that TE has identified as EU RoHS compliant have a maximum concentration of 0.1% by weight in homogenous materials for lead, hexavalent chromium, mercury, PBB, PBDE, DBP, BBP, DEHP, DIBP, and 0.01% for cadmium, or qualify for an exemption to these limits as defined in the Annexes of Directive 2011/65/EU (RoHS2). Finished electrical and electronic equipment products will be CE marked as required by Directive 2011/65/EU. Components may not be CE marked. Additionally, the part numbers that TE has identified as EU ELV compliant have a maximum concentration of 0.1% by weight in homogenous materials for lead, hexavalent chromium, and mercury, and 0.01% for cadmium, or qualify for an exemption to these limits as defined in the Annexes of Directive 2000/53/EC (ELV). Regarding the REACH Regulation, the information TE provides on SVHC in articles for this part number is based on the latest European Chemicals Agency (ECHA) 'Guidance on requirements for substances in articles' posted at this URL: <https://echa.europa.eu/guidance-documents/guidance-on-reach>

Compatible Parts

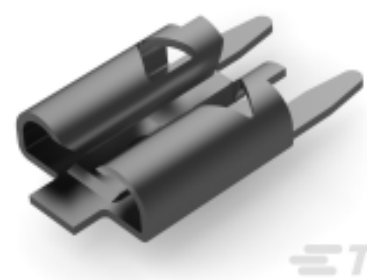

TE Part # 1217080-1
FASTON 205/250 PCB MOUNTED
TPBR



TE Part # 1217107-1
250 FASTON,REC.,TPPB



TE Part # 63968-1
FASTON 205/250 LIF PCB MOUNTED
TPBR

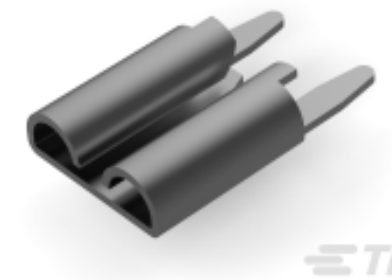

TE Part # 63994-1
FASTON 205/250 PCB MOUNTED
TPBR



TE Part # 62806-1
FASTON 250 PCB TAB TPBR

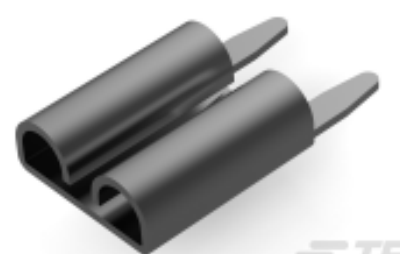

TE Part # 1217137-1
FASTON 250/205 REC PCB TPBR

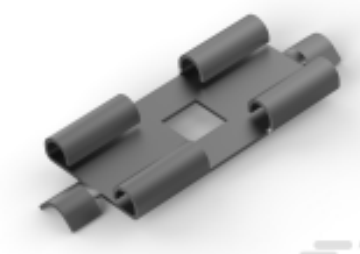

TE Part # 62751-1
FASTON 250 PCB TAB TPBR

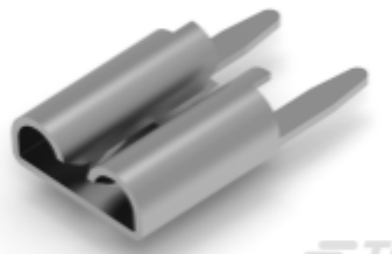

TE Part # 1217137-2
FASTON 205/250 PCB MOUNTED
TPBR

Also in the Series | FASTON 205

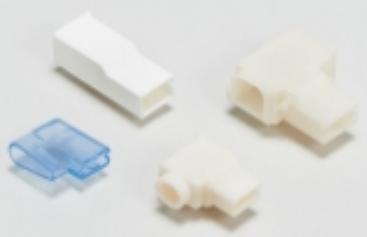

Crimp Terminal Housings(3)



PCB Terminals(9)

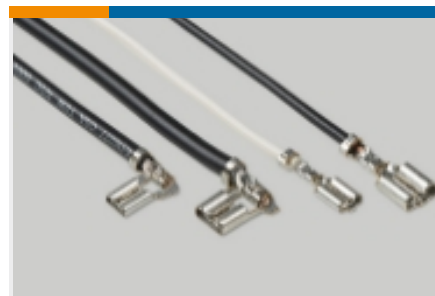

Quick Disconnects(36)

Customers Also Bought



TE Part #4-1622820-1
3520 390R 5%



TE Part #1879450-5
TE 500W 2R2 5% Bracket



TE Part #641968-1
04P UMNL PIN HDR ASSY POL 94VO



TE Part #770829-1
04P CMNL HDR R/A BLK HT T/L



TE Part #2321919-4
FRONT TPA PLUG HOUSING, 4 POS



TE Part #641936-6
09P MTA156 HDR ASSY F/L W/O#8



TE Part #644029-1
14P MTA156 HDR ASSY W/O#8

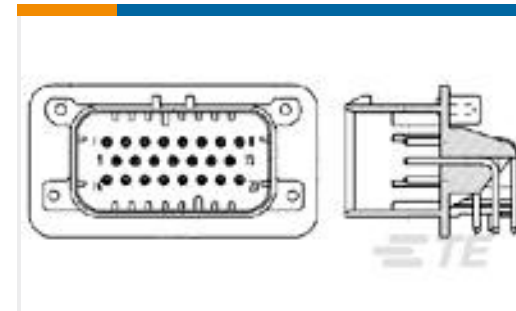

TE Part #776267-1
14POS, PIN DIA 1.3, HDR ASSY, 90DEG,
COD 1

Documents

Product Drawings

FASTON 205/250 PCB MOUNTED TPBR

English

CAD Files

3D PDF

3D

Customer View Model

[ENG_CVM_CVM_63969-1_C.2d_dxf.zip](#)

English

Customer View Model

[ENG_CVM_CVM_63969-1_C.3d_igs.zip](#)

English

Customer View Model

[ENG_CVM_CVM_63969-1_C.3d_stp.zip](#)

English

By downloading the CAD file I accept and agree to the [Terms and Conditions](#) of use.

Datasheets & Catalog Pages

FASTON PCB Tabs and Receptacles

English

PRINTED CIRCUIT BOARD TERMINALS AND DISCONNECTS

English

Product Specifications

Application Specification

English



Application Specification

English

Product Environmental Compliance

[MD_63969-1_05262017355_dmtec](#)

English

[MD_63969-1_05262017355_dmtec](#)

English