

5745173-3 ✓ ACTIVE

AMPLIMITE | AMPLIMITE Kit

TE Internal #: 5745173-3

D-Sub Backshells & Clamps, Cable Clamp Kit, Two-Piece RFI/EMI Shield, 25 Position, Size 3, Shielded, Cable Exit Angle 180° (In-Line), AMPLIMITE Kit

[View on TE.com >](#)



Connectors > D-Shaped Connectors > D-Sub Accessories > D-Sub Backshells & Clamps



D-Shaped Connector Accessories: **Cable Clamp Kit**

Cable Clamp Type: **Two-Piece RFI/EMI Shield**

Number of Positions: **25**

Compatible With Connector Shell Size: **3**

Shielded: **Yes**

Features

Product Type Features

Grommets	Without
Product Type	Accessory
D-Shaped Connector Accessories	Cable Clamp Kit

Configuration Features

Number of Positions	25
---------------------	----

Body Features

Shield Plating Material	Nickel over Copper
Cable Clamp Material	Zinc Alloy
Shield Plating Finish	Bright
Cable Clamp Type	Two-Piece RFI/EMI Shield
Cable Exit Angle	180° (In-Line)

Mechanical Attachment

Screw & Hole Thread Size	4-40
--------------------------	------



Dimensions

Cable Insulation Diameter Range	10.92 mm[.43 in]
---------------------------------	------------------

Usage Conditions

Operating Temperature Range	-55 – 85 °C[-67 – 185 °F]
-----------------------------	---------------------------

Operation/Application

For Use With	Plug/Receptacle
Compatible With Connector Shell Size	3
Shielded	Yes

Packaging Features

Packaging Quantity	1
Packaging Method	Kit

Other

Comment	All parts are packaged unassembled., Jackscrews must be purchased separately., Shielded cable clamps will not accept connector housings with clinch nuts.
Long Turnable Jackscrew Part Number	747784-3

Product Compliance

[For compliance documentation, visit the product page on TE.com>](#)

EU RoHS Directive 2011/65/EU	Compliant
EU ELV Directive 2000/53/EC	Compliant
China RoHS 2 Directive MIIT Order No 32, 2016	No Restricted Materials Above Threshold
EU REACH Regulation (EC) No. 1907/2006	Current ECHA Candidate List: JUNE 2022 (224) Candidate List Declared Against: JAN 2022 (223) SVHC > Threshold: Not Yet Reviewed
Halogen Content	Low Halogen - Br, Cl, F, I < 900 ppm per homogenous material. Also BFR/CFR/PVC Free
Solder Process Capability	Not applicable for solder process capability

Product Compliance Disclaimer

This information is provided based on reasonable inquiry of our suppliers and represents our current actual knowledge based on the information they provided. This information is subject to change. The part numbers that TE has identified as EU RoHS compliant have a maximum concentration of 0.1% by weight in homogenous materials for lead, hexavalent



chromium, mercury, PBB, PBDE, DBP, BBP, DEHP, DIBP, and 0.01% for cadmium, or qualify for an exemption to these limits as defined in the Annexes of Directive 2011/65/EU (RoHS2). Finished electrical and electronic equipment products will be CE marked as required by Directive 2011/65/EU. Components may not be CE marked. Additionally, the part numbers that TE has identified as EU ELV compliant have a maximum concentration of 0.1% by weight in homogenous materials for lead, hexavalent chromium, and mercury, and 0.01% for cadmium, or qualify for an exemption to these limits as defined in the Annexes of Directive 2000/53/EC (ELV). Regarding the REACH Regulation, the information TE provides on SVHC in articles for this part number is based on the latest European Chemicals Agency (ECHA) 'Guidance on requirements for substances in articles' posted at this URL: <https://echa.europa.eu/guidance-documents/guidance-on-reach>

Compatible Parts



TE Part # 1-745496-7
25 HDE MS PLUG, 22-26, LEAD FREE



TE Part # 745255-2
SPRING LATCH 2/BAG

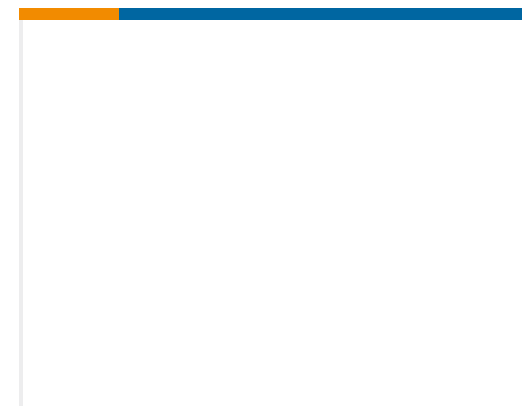

TE Part # 787308-8
CABLE CLAMP, SZ 3, K NECK, PLTD

Also in the Series | AMPLIMITE Kit



D-Sub Backshells & Clamps(135)



D-Sub Contact Accessories(1)



D-Sub Covers(3)



D-Sub Locking & Mounting(122)

Customers Also Bought



TE Part #5745171-1
SIZE 1 ASSY KIT .250



TE Part #5745174-5
CABLE CLAMP KIT, SZ 4

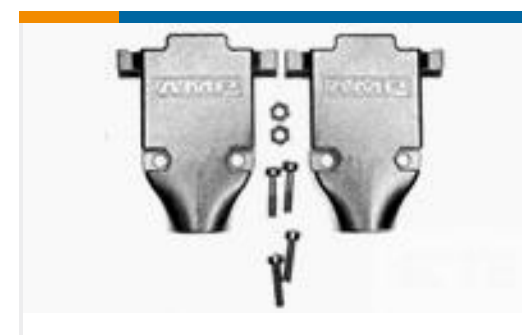

TE Part #5745174-4
CABLE CLAMP KIT, SZ 4, .425

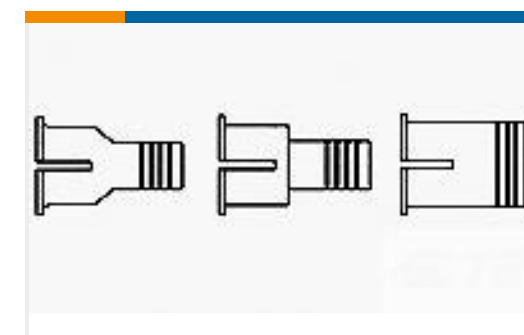

TE Part #7-745129-1
SHLDING FERRULE, PLTD, BULK PKG

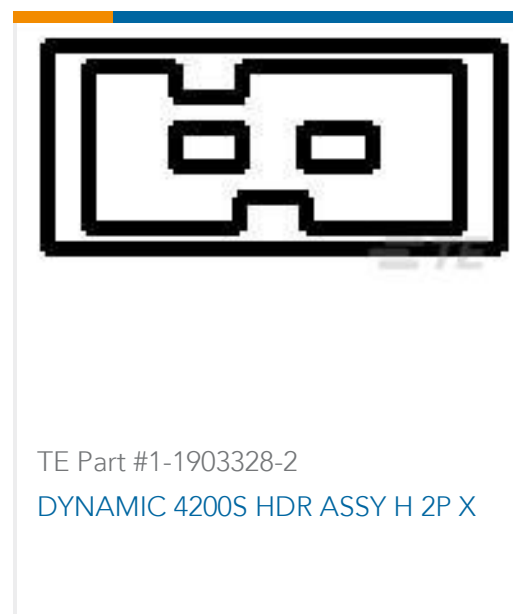

Documents

Product Drawings

CABLE CLAMP KIT, SZ 3

English

CAD Files

3D PDF

3D

Customer View Model

[ENG_CVM_CVM_5745173-3_O.2d_dxf.zip](#)

English

Customer View Model

[ENG_CVM_CVM_5745173-3_O.3d_igs.zip](#)

English

Customer View Model

[ENG_CVM_CVM_5745173-3_O.3d_stp.zip](#)

English

By downloading the CAD file I accept and agree to the [Terms and Conditions](#) of use.

Datasheets & Catalog Pages

AMPLIMITE Subminiature D Connectors - Cable Connectors

English

AMPLIMITE Cable Connectors and Shielding Hardware Kits QRG

English

Product Specifications

Product Specification

English



Product Specification

English

Product Environmental Compliance

[MD_5745173-3_020620191133_dmtec](#)

English

[MD_5745173-3_020620191133_dmtec](#)

English

Instruction Sheets

[Instruction Sheet \(U.S.\)](#)

English