

5646442-1 ✓ ACTIVE

Z-PACK | Z-PACK 2mm HM

TE Internal #: 5646442-1

Hard Metric Backplane Connectors, PCB Mount Receptacle,  $\leq 1$  Gb/s, 25 Column, 8 Row, Mezzanine, Board-to-Board, 176 Position, Z-PACK 2mm HM

[View on TE.com >](#)



Connectors > PCB Connectors > Backplane Connectors > Hard Metric Connectors >

HM Receptacle Connector: Traditional Backplane, Coplanar, 2mm

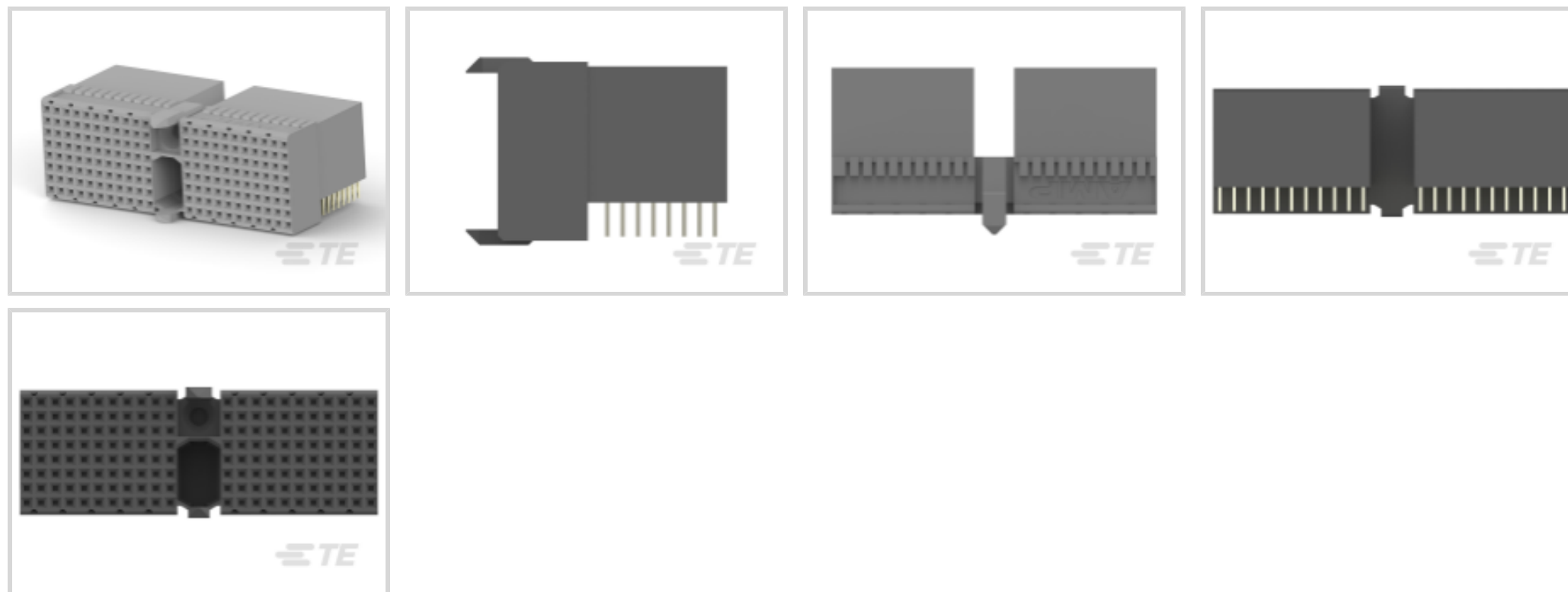

PCB Connector Assembly Type: **PCB Mount Receptacle**

Data Rate:  $\leq 1$  Gb/s

Number of Columns: **25**

Number of Rows: **8**

Backplane Architecture: **Mezzanine**

[All HM Receptacle Connector: Traditional Backplane, Coplanar, 2mm \(48\)](#)

## Features

### Product Type Features

Backplane Interface Type	2mm HM
PCB Connector Assembly Type	PCB Mount Receptacle
Connector System	Board-to-Board
Sealable	No
Connector & Contact Terminates To	Printed Circuit Board

### Configuration Features

Rows Loaded	A, B, C, D, E, F, G, H
Number of Signal Positions	176
Number of Columns	25
Number of Rows	8
Backplane Architecture	Mezzanine
Number of Positions	176



PCB Mount Orientation	Right Angle
-----------------------	-------------

### Signal Characteristics

Crosstalk Version	Standard
-------------------	----------

Data Rate	≤1 Gb/s
-----------	---------

### Contact Features

Feedthrough Post Length	3.3 mm
-------------------------	--------

Contact Type	Socket
--------------	--------

Contact Underplating Material	Nickel
-------------------------------	--------

PCB Contact Termination Area Plating Material	Tin
---	-----

Contact Base Material	Phosphor Bronze
-----------------------	-----------------

CompactPCI Designation	None
------------------------	------

Contact Mating Area Plating Material	Performance Based
--------------------------------------	-------------------

Contact Mating Area Plating Material Thickness	.76 μm[30 μin]
--	----------------

Contact Current Rating (Max)	1.5 A
------------------------------	-------

### Termination Features

Termination Method to Printed Circuit Board	Through Hole - Press-Fit
---	--------------------------

### Mechanical Attachment

Mating Alignment Type	Multi-Purpose Center
-----------------------	----------------------

Connector Mounting Type	Board Mount
-------------------------	-------------

### Housing Features

Housing Material	Polyester - GF
------------------	----------------

Centerline (Pitch)	2 mm[.078 in]
--------------------	---------------

Housing Color	Gray
---------------	------

### Dimensions

Backplane Module Length	48 mm
-------------------------	-------

### Usage Conditions

Operating Temperature Range	-55 – 125 °C[-67 – 257 °F]
-----------------------------	----------------------------

### Operation/Application

Shielded	No
----------	----

Circuit Application	Signal
---------------------	--------

### Industry Standards



UL Flammability Rating	UL 94V-0
------------------------	----------

AdvancedTCA Specified Product	No
-------------------------------	----

### Packaging Features

Packaging Quantity	10
--------------------	----

Packaging Method	Box
------------------	-----

### Product Compliance

[For compliance documentation, visit the product page on TE.com>](#)

EU RoHS Directive 2011/65/EU	Compliant
------------------------------	-----------

EU ELV Directive 2000/53/EC	Compliant
-----------------------------	-----------

China RoHS 2 Directive MIIT Order No 32, 2016	No Restricted Materials Above Threshold
---	---

EU REACH Regulation (EC) No. 1907/2006	Current ECHA Candidate List: JUNE 2022 (224) Candidate List Declared Against: JAN 2022 (223) SVHC > Threshold: Not Yet Reviewed
--	--

Halogen Content	Not Low Halogen - contains Br or Cl > 900 ppm.
-----------------	--

Solder Process Capability	Not applicable for solder process capability
---------------------------	--

#### Product Compliance Disclaimer

This information is provided based on reasonable inquiry of our suppliers and represents our current actual knowledge based on the information they provided. This information is subject to change. The part numbers that TE has identified as EU RoHS compliant have a maximum concentration of 0.1% by weight in homogenous materials for lead, hexavalent chromium, mercury, PBB, PBDE, DBP, BBP, DEHP, DIBP, and 0.01% for cadmium, or qualify for an exemption to these limits as defined in the Annexes of Directive 2011/65/EU (RoHS2). Finished electrical and electronic equipment products will be CE marked as required by Directive 2011/65/EU. Components may not be CE marked. Additionally, the part numbers that TE has identified as EU ELV compliant have a maximum concentration of 0.1% by weight in homogenous materials for lead, hexavalent chromium, and mercury, and 0.01% for cadmium, or qualify for an exemption to these limits as defined in the Annexes of Directive 2000/53/EC (ELV). Regarding the REACH Regulation, the information TE provides on SVHC in articles for this part number is based on the latest European Chemicals Agency (ECHA) 'Guidance on requirements for substances in articles' posted at this URL: <https://echa.europa.eu/guidance-documents/guidance-on-reach>

### Compatible Parts



TE Part # CAT-472-Z12  
Hard Metric Male Connector:  
Traditional Backplane, Mezzanine,  
2mm



TE Part # 6645307-1  
2MM H.M. 8 ROW TYPE "D" PIN AS

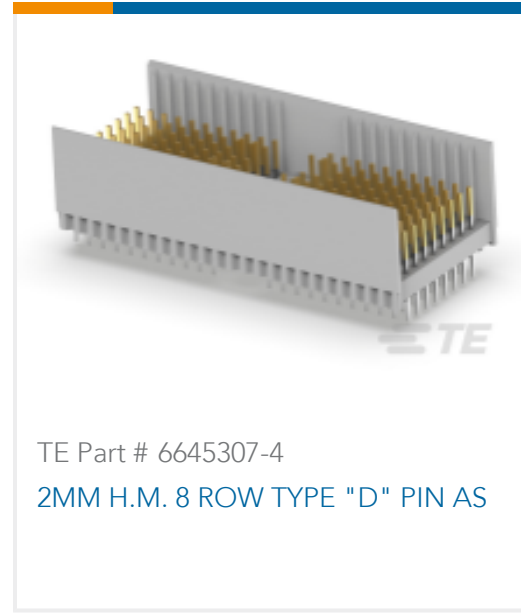

TE Part # 6645307-4  
2MM H.M. 8 ROW TYPE "D" PIN AS



TE Part # 6645307-9  
2MM H.M. 8 ROW TYPE "D" PIN AS

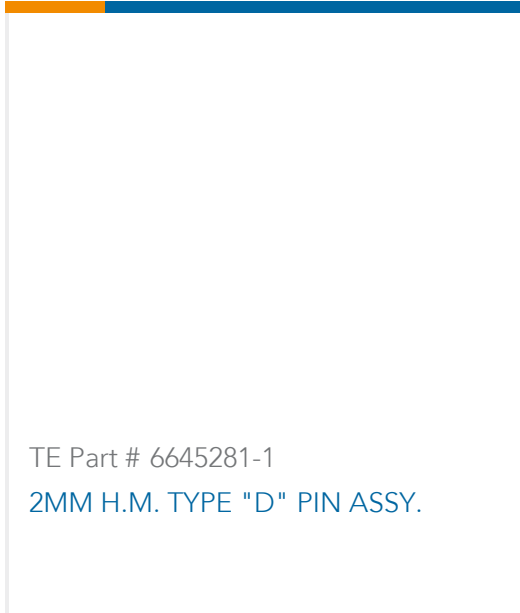

TE Part # 6645281-1  
2MM H.M. TYPE "D" PIN ASSY.

## Also in the Series | Z-PACK 2mm HM



Backplane Coding Keys(60)

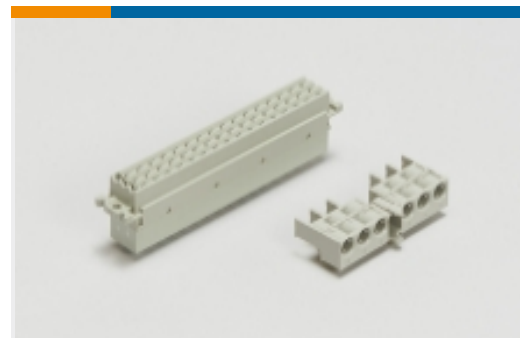

Backplane Connector Housings(4)



Backplane Guide Hardware(37)

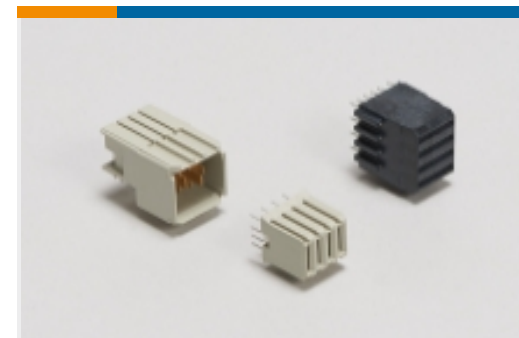

Backplane Power Connectors(6)



Board-to-Board Connector Contacts(2)

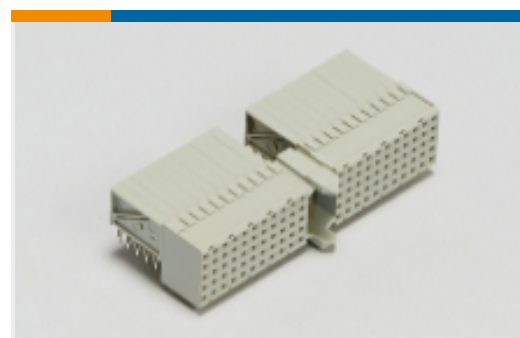

Hard Metric Backplane Connectors  
(269)

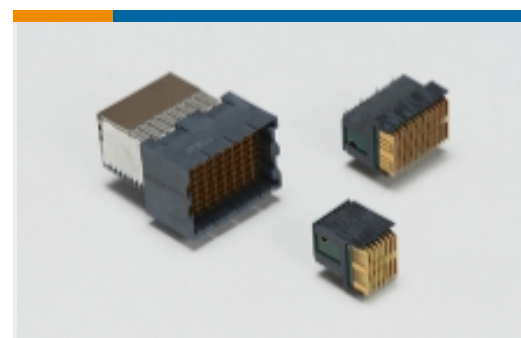

High Speed Backplane Connectors(1)



Insertion & Extraction Tools(2)

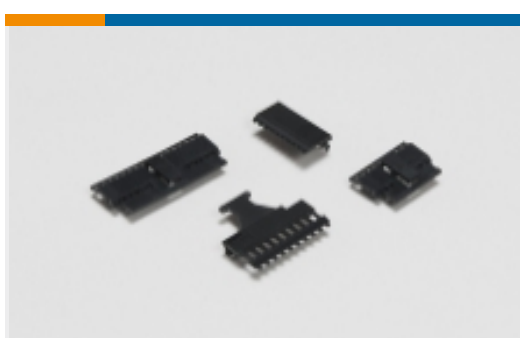

PCB Connector Covers(4)



PCB Connector Shrouds(39)



PCB Ferrules & Shields(19)

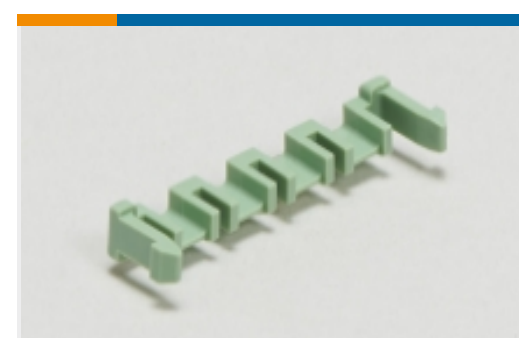

PCB Latches, Locks & Retainers(1)





Rectangular Power Connectors(87)

## Customers Also Bought

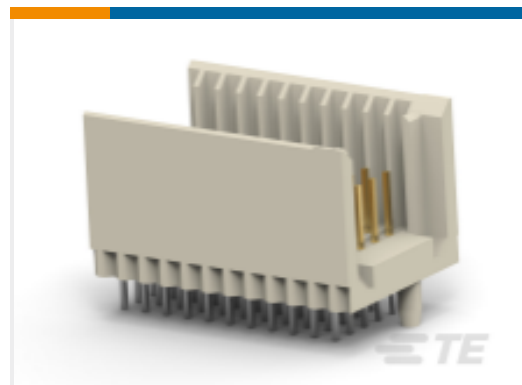

TE Part #5100141-1  
Hard Metric Male Connector:  
Traditional Backplane, Mezzanine,  
2mm



TE Part #5100145-1  
HM Receptacle Connector: Traditional  
Backplane, Coplanar, 2mm



TE Part #6469083-1  
HMZD 3PAIR, HDR ASSY, 25MM MOD

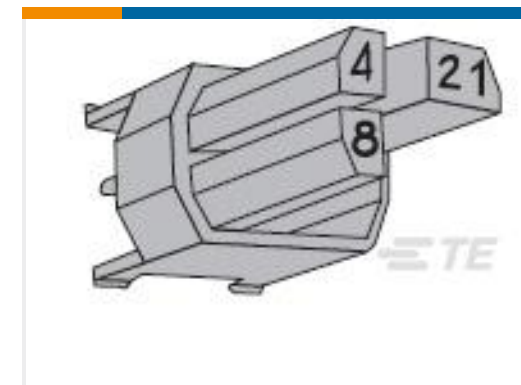

TE Part #5-100525-6  
Z-PACK M.CODING KEY

## Documents

### Product Drawings

[2MM HM,ASY,T-D,REC,TWIST TULIP](#)

English

### CAD Files

Customer View Model

[ENG\\_CVM\\_CVM\\_5646442-1\\_O.2d\\_dxf.zip](#)

English

3D PDF

3D

Customer View Model

[ENG\\_CVM\\_CVM\\_5646442-1\\_O.3d\\_igs.zip](#)

English

Customer View Model

[ENG\\_CVM\\_CVM\\_5646442-1\\_O.3d\\_stp.zip](#)

English

By downloading the CAD file I accept and agree to the [Terms and Conditions](#) of use.

### Product Specifications

[Application Specification](#)

English

### Product Environmental Compliance

[TE Material Declaration](#)

English

5646442-1

Hard Metric Backplane Connectors, PCB Mount Receptacle, ≤1 Gb/s, 25 Column, 8 Row, Mezzanine, Board-to-Board, 176 Position, Z-PACK 2mm HM

