

60196-1 ✓ ACTIVE

FASTON | FASTON 187

TE Internal #: 60196-1

Quick Disconnects, Receptacle, 20 – 16 AWG Wire Size, .51 – 1.31 mm<sup>2</sup> Wire Size, Mating Tab Width .187 in [4.75 mm], Straight, Brass, FASTON 187

[View on TE.com >](#)



Terminals & Splices > Quick Disconnects

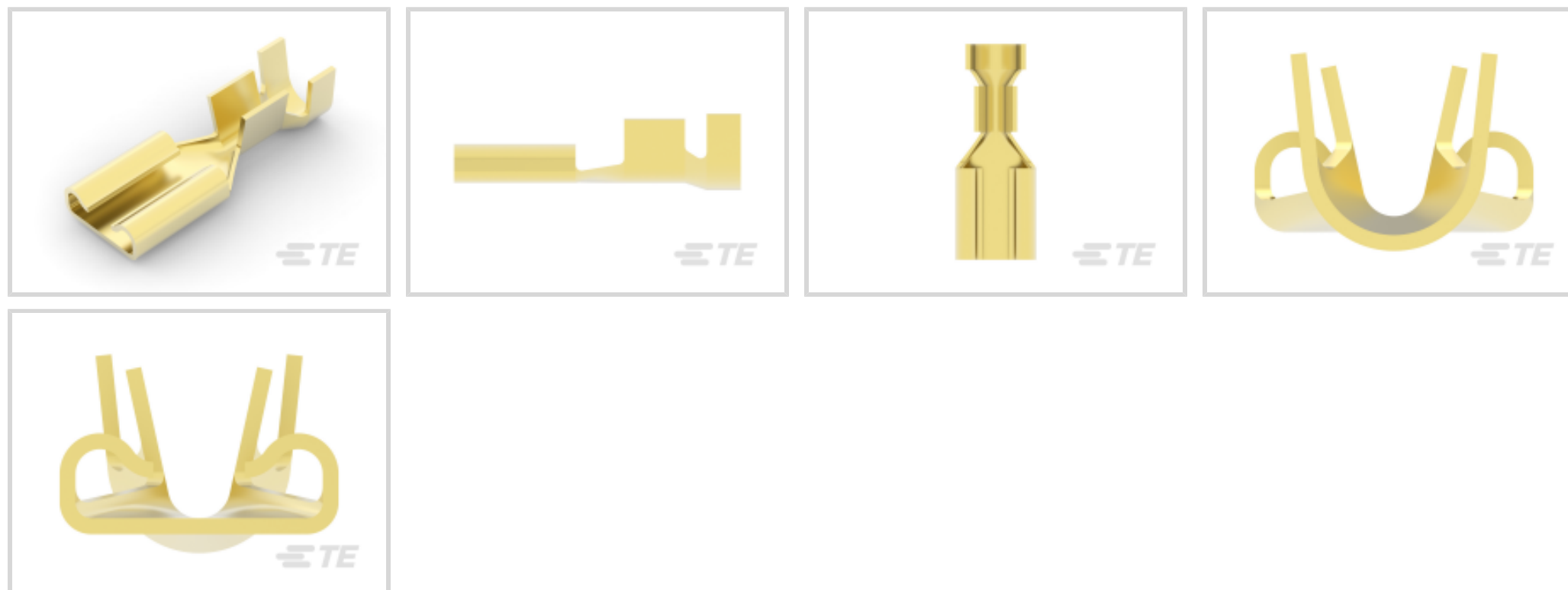

Quick Disconnect Terminal Type: **Receptacle**

Wire Size: .51 – 1.31 mm<sup>2</sup>

Mating Tab Width: 4.75 mm [.187 in ]

Mating Tab Thickness: .81 mm [.032 in ]

## Features

### Product Type Features

Terminates To	Wire & Cable
Wire Stop	No
Wire/Cable Type	Regular Wire
Insertion Force	Normal
Sealable	No

### Configuration Features

Connection Capacity	Single
---------------------	--------

### Contact Features

Quick Disconnect Terminal Type	Receptacle
Mating Tab Width	4.75 mm [.187 in]
Mating Tab Thickness	.81 mm [.032 in]
Terminal Orientation	Straight
Contact Base Material	Brass
Terminal Plating Material	Unplated
Crimp Type	F-Crimp



Barrel Type	Open
-------------	------

### Mechanical Attachment

Mating Retention Type	Dimple
Wire Insulation Support	With

### Dimensions

Accepts Wire Insulation Diameter Range	2.29 – 3.3 mm [.09 – .13 in]
Overall Length	14.99 mm [.59 in]
Receptacle Terminal Stock Thickness	.3 mm [.012 in]
Wire Size	.51 – 1.31 mm <sup>2</sup>

### Usage Conditions

Insulation Option	Uninsulated
Operating Temperature Range	-40 – 110 °C [-40 – 230 °F]

### Industry Standards

UL Rating	Listed
CSA Certified	Yes

### Packaging Features

Packaging Quantity	20000
Packaging Method	Strip/Reel

### Product Compliance

[For compliance documentation, visit the product page on TE.com>](#)

EU RoHS Directive 2011/65/EU	Compliant
EU ELV Directive 2000/53/EC	Compliant
China RoHS 2 Directive MIIT Order No 32, 2016	No Restricted Materials Above Threshold
EU REACH Regulation (EC) No. 1907/2006	Current ECHA Candidate List: JUNE 2022 (224) Candidate List Declared Against: JAN 2022 (223) SVHC > Threshold: Not Yet Reviewed
Halogen Content	Low Halogen - Br, Cl, F, I < 900 ppm per homogenous material. Also BFR/CFR/PVC Free
Solder Process Capability	Not applicable for solder process capability

## Product Compliance Disclaimer

This information is provided based on reasonable inquiry of our suppliers and represents our current actual knowledge based on the information they provided. This information is subject to change. The part numbers that TE has identified as EU RoHS compliant have a maximum concentration of 0.1% by weight in homogenous materials for lead, hexavalent chromium, mercury, PBB, PBDE, DBP, BBP, DEHP, DIBP, and 0.01% for cadmium, or qualify for an exemption to these limits as defined in the Annexes of Directive 2011/65/EU (RoHS2). Finished electrical and electronic equipment products will be CE marked as required by Directive 2011/65/EU. Components may not be CE marked. Additionally, the part numbers that TE has identified as EU ELV compliant have a maximum concentration of 0.1% by weight in homogenous materials for lead, hexavalent chromium, and mercury, and 0.01% for cadmium, or qualify for an exemption to these limits as defined in the Annexes of Directive 2000/53/EC (ELV). Regarding the REACH Regulation, the information TE provides on SVHC in articles for this part number is based on the latest European Chemicals Agency (ECHA) 'Guidance on requirements for substances in articles' posted at this URL: <https://echa.europa.eu/guidance-documents/guidance-on-reach>

## Compatible Parts



Also in the Series | **FASTON 187**



Crimp Terminal Housings(41)



Insertion & Extraction Tools(1)



Joints & Splices(1)



PCB Terminals(48)



Quick Disconnects(214)



Splices(1)

## Customers Also Bought



TE Part #2-1744036-6  
06P ECONOMY POWER .200 CL HSG

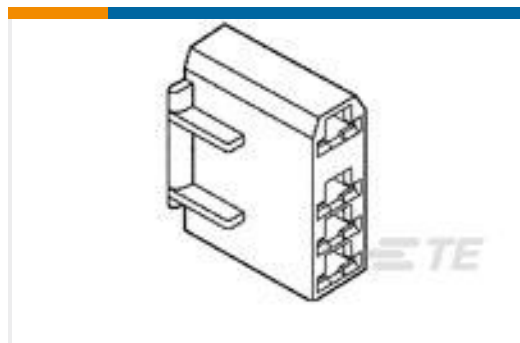

TE Part #520987-1  
250 FASTON HSG. REC 4P BLACK



TE Part #42510-1  
250 FASTON REC 22-18 AWG BR



TE Part #4-240651-2  
BLADE, SLUG

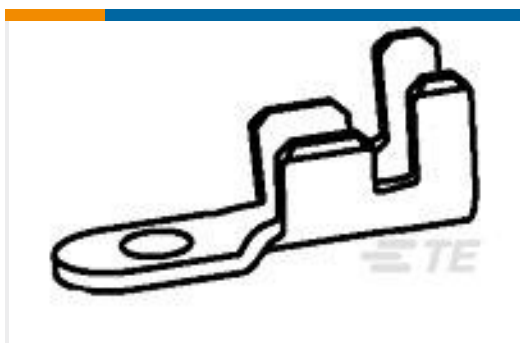

TE Part #40990-1  
WELD TAB TAB 20-16 AWG TPSTL

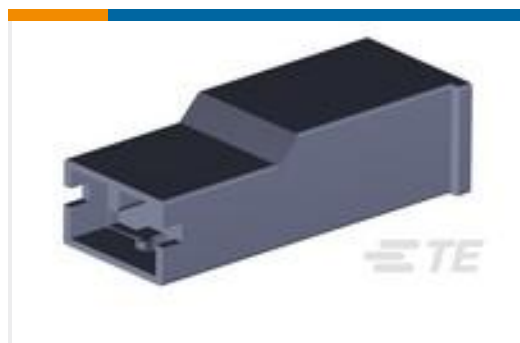

TE Part #1-2133341-1  
PL MK1 RECEPTACLE NATURAL 6.6 PA

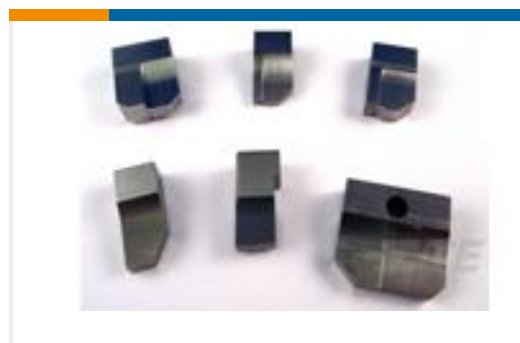

TE Part #7-1333202-5  
ANVIL, COMBINATION .062

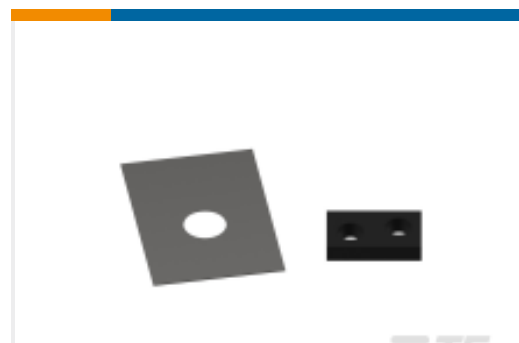

TE Part #238009-1  
BLOCK, CRIMPER SPACER (.130)



TE Part #2232900-6  
ECONOMY POWER TPA RETAINER

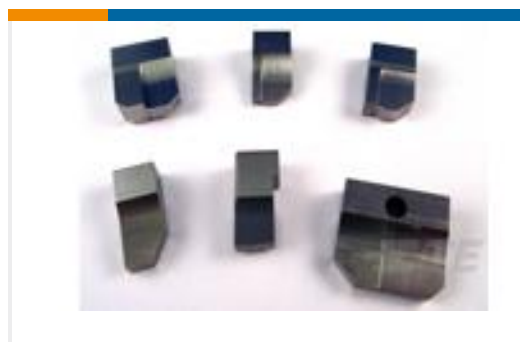

TE Part #1-690471-2  
COMB ANVIL

## Documents



## Product Drawings

### 187 FASTON REC 20-16 AWG BR

English

---

## CAD Files

### Customer View Model

[ENG\\_CVM\\_CVM\\_60196-1\\_CD.2d\\_dxf.zip](#)

English

### 3D PDF

3D

### Customer View Model

[ENG\\_CVM\\_CVM\\_60196-1\\_CD.3d\\_igs.zip](#)

English

### Customer View Model

[ENG\\_CVM\\_CVM\\_60196-1\\_CD.3d\\_stp.zip](#)

English

By downloading the CAD file I accept and agree to the [Terms and Conditions](#) of use.

---

## Datasheets & Catalog Pages

### 82004 FASTON Terminals (Insulated and Uninsulated) Catalog - FASTON Receptacles Section

English

---

## Product Specifications

### Application Specification

English

---

## Product Environmental Compliance

### TE Material Declaration

English

---

## Agency Approvals

### UL Report

English