

63824-1 ✓ ACTIVE

FASTON | FASTON 250

TE Internal #: 63824-1

PCB Terminals, Tab, Mating Tab Width 6.35 mm [.25 in], PCB Hole Diameter 1.4 mm [.055 in], Through Hole - Solder, Tin Plating, FASTON 250

[View on TE.com >](#)



Terminals & Splices > PCB Terminals

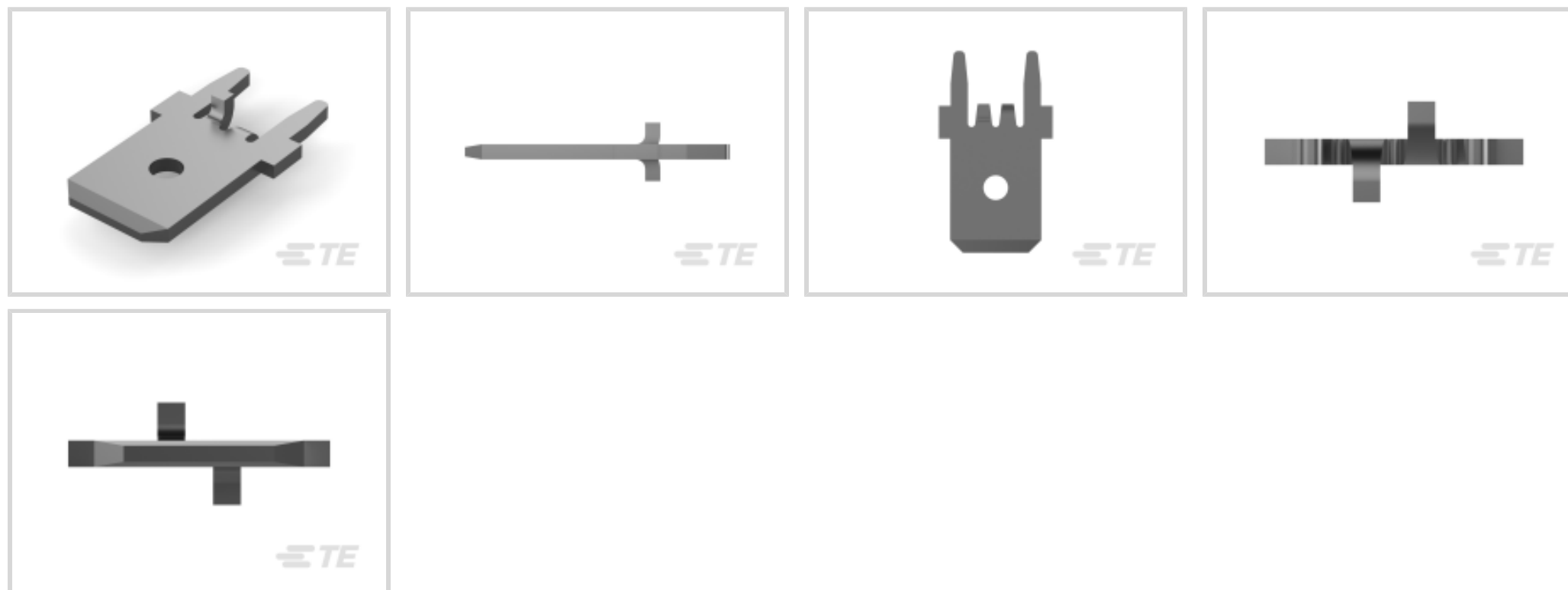

PCB Terminal Type: **Tab**

PCB Thickness (Recommended): 1.57 mm [.062 in]

Mating Tab Width: 6.35 mm [.25 in]

Mating Tab Thickness: .81 mm [.032 in]

PCB Hole Diameter: 1.4 mm [.055 in]

## Features

### Configuration Features

Stud Hole	No
Terminal Angle	180 °

### Contact Features

Contact Plating Material	Tin
PCB Terminal Type	Tab
Mating Tab Width	6.35 mm [.25 in]
Mating Tab Thickness	.81 mm [.032 in]
Terminal Plating Material	Tin
Contact Underplating Material	Copper or Nickel
Terminal Size	6.35
Terminal Orientation	Straight

### Termination Features

Termination Method to Printed Circuit Board	Through Hole - Solder
Product Terminates To	Printed Circuit Board



### Mechanical Attachment

Wire Insulation Support	With
-------------------------	------

### Dimensions

Extension Below Board	3.81 mm[.15 in]
Receptacle Terminal Stock Thickness	.81 mm[.032 in]
PCB Thickness (Recommended)	1.57 mm[.062 in]
PCB Hole Diameter	1.4 mm[.055 in]
Profile Height from PCB	10.21 mm[.402 in]

### Usage Conditions

Insulation Option	Uninsulated
Operating Temperature Range	-30 – 110 °C[-22 – 230 °F]

### Packaging Features

Packaging Quantity	10000
Packaging Method	Reel

### Other

Comment	.2 brass material., Insertion equipment available.
---------	----------------------------------------------------

### Product Compliance

[For compliance documentation, visit the product page on TE.com>](#)

EU RoHS Directive 2011/65/EU	Compliant
EU ELV Directive 2000/53/EC	Compliant
China RoHS 2 Directive MIIT Order No 32, 2016	No Restricted Materials Above Threshold
EU REACH Regulation (EC) No. 1907/2006	Current ECHA Candidate List: JUNE 2022 (224) Candidate List Declared Against: JAN 2022 (223) SVHC > Threshold: Not Yet Reviewed
Halogen Content	Low Halogen - Br, Cl, F, I < 900 ppm per homogenous material. Also BFR/CFR/PVC Free
Solder Process Capability	Wave solder capable to 265°C

Product Compliance Disclaimer

This information is provided based on reasonable inquiry of our suppliers and represents our current actual knowledge based on the information they provided. This information is subject to change. The part numbers that TE has identified as EU RoHS compliant have a maximum concentration of 0.1% by weight in homogenous materials for lead, hexavalent chromium, mercury, PBB, PBDE, DBP, BBP, DEHP, DIBP, and 0.01% for cadmium, or qualify for an exemption to these limits as defined in the Annexes of Directive 2011/65/EU (RoHS2). Finished electrical and electronic equipment products will be CE marked as required by Directive 2011/65/EU. Components may not be CE marked. Additionally, the part numbers that TE has identified as EU ELV compliant have a maximum concentration of 0.1% by weight in homogenous materials for lead, hexavalent chromium, and mercury, and 0.01% for cadmium, or qualify for an exemption to these limits as defined in the Annexes of Directive 2000/53/EC (ELV). Regarding the REACH Regulation, the information TE provides on SVHC in articles for this part number is based on the latest European Chemicals Agency (ECHA) 'Guidance on requirements for substances in articles' posted at this URL: <https://echa.europa.eu/guidance-documents/guidance-on-reach>

## Compatible Parts





## Also in the Series | FASTON 250

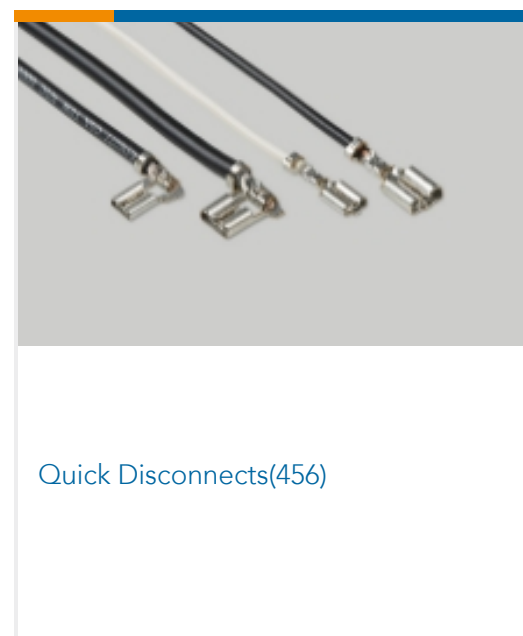
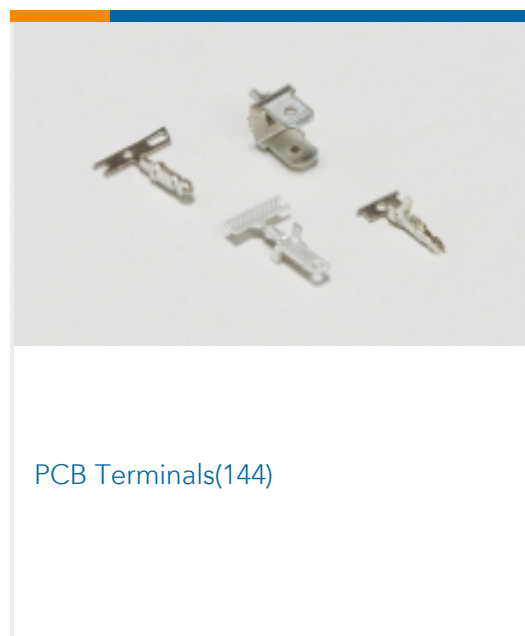
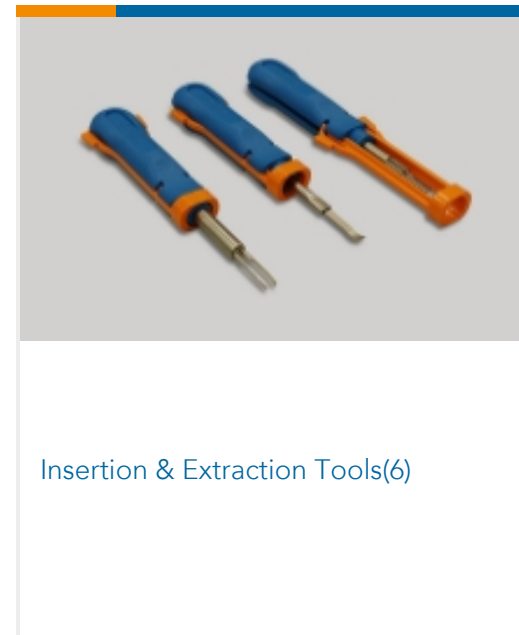
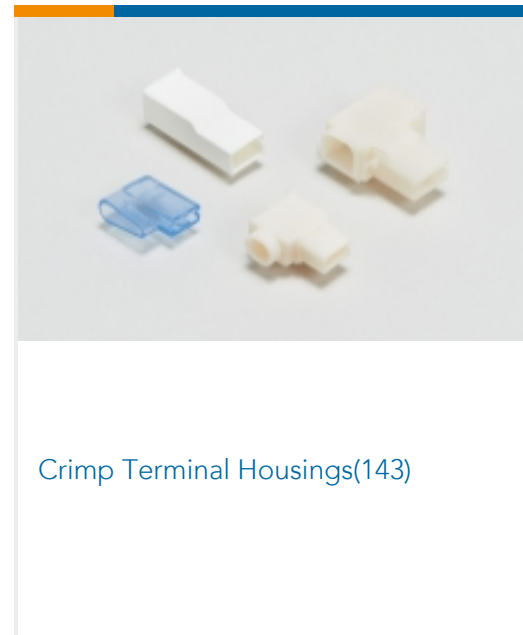
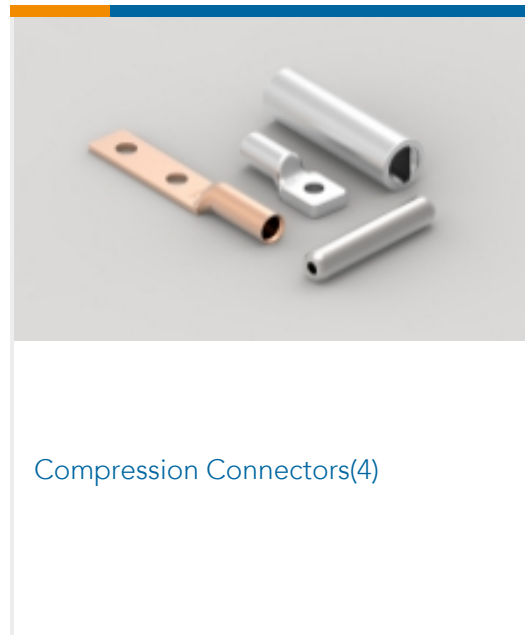

## Customers Also Bought

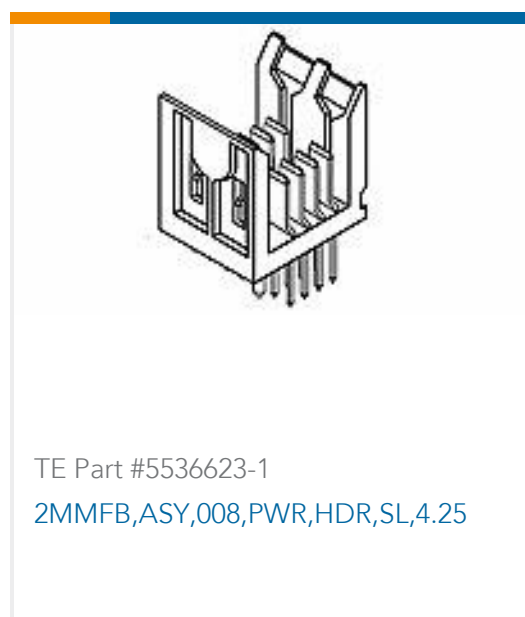

## Documents

### Product Drawings

#### 250 FASTON TAB TPBR

English

---

### CAD Files

#### 3D PDF

3D

#### Customer View Model

[ENG\\_CVM\\_CVM\\_63824-1\\_AD\\_c-63824-1-ad.2d\\_dxf.zip](#)

English

#### Customer View Model

[ENG\\_CVM\\_CVM\\_63824-1\\_AD\\_c-63824-1-ad.3d\\_igs.zip](#)

English

#### Customer View Model

[ENG\\_CVM\\_CVM\\_63824-1\\_AD\\_c-63824-1-ad.3d\\_stp.zip](#)

English

By downloading the CAD file I accept and agree to the [Terms and Conditions](#) of use.

---

### Datasheets & Catalog Pages

#### FASTON PCB Tabs and Receptacles

English

#### PRINTED CIRCUIT BOARD TERMINALS AND DISCONNECTS

English

---

### Product Specifications

#### Application Specification

English

#### Application Specification

English

---

### Product Environmental Compliance

#### MD\_63824-1\_11262018340\_dmtec

English

#### MD\_63824-1\_11262018340\_dmtec

English

---

### Agency Approvals

#### CSA Certificate

English

#### CSA Certificate

English