

61281-3 ✓ ACTIVE

FASTON | FASTON 250

TE Internal #: 61281-3

Quick Disconnects, Tab, 14 – 12 AWG Wire Size, 2.1 – 3.31 mm²

Wire Size, Mating Tab Width .25 in [6.35 mm], Straight, Brass, Tin

Plating, FASTON 250

[View on TE.com >](#)



Terminals & Splices > Quick Disconnects

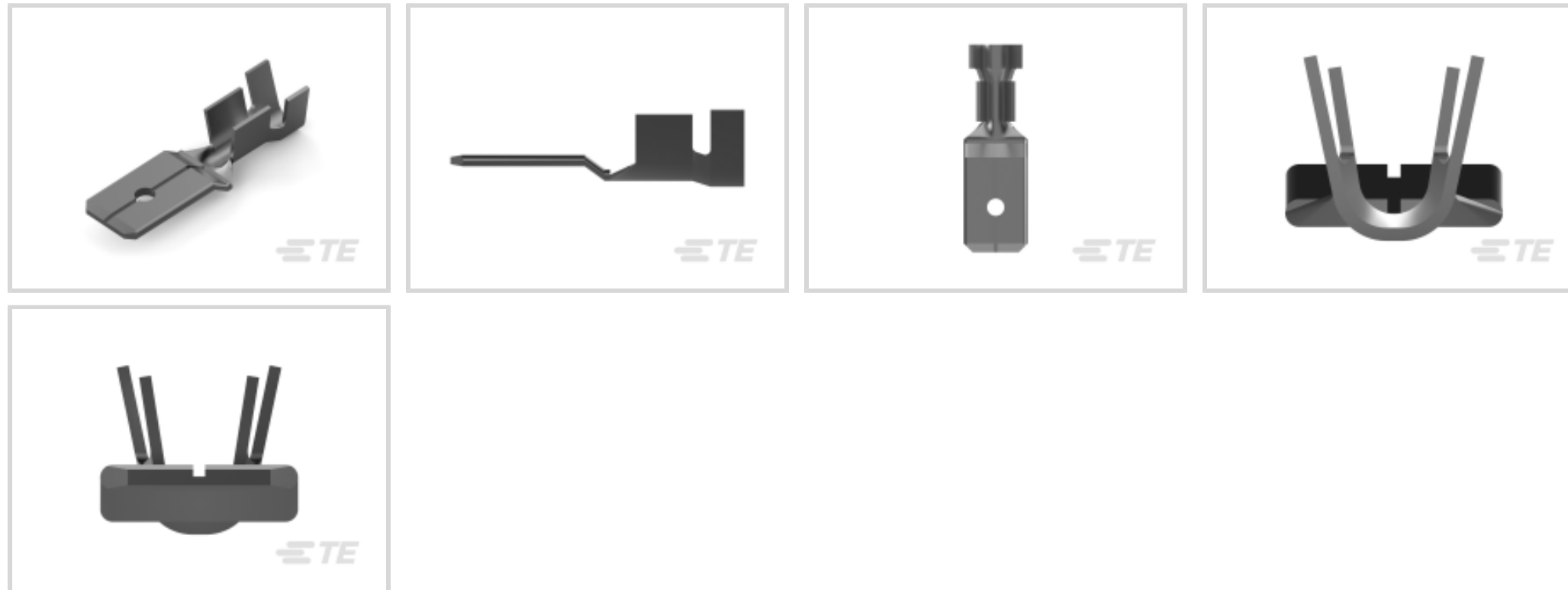

Quick Disconnect Terminal Type: **Tab**

Wire Size: **2.1 – 3.31 mm²**

Mating Tab Width: **6.35 mm [.25 in]**

Mating Tab Thickness: **.81 mm [.032 in]**

Features

Product Type Features

Terminates To	Wire & Cable
Wire Stop	No
Wire/Cable Type	Regular Wire
Insertion Force	Normal
Sealable	No

Configuration Features

Connection Capacity	Single
---------------------	--------

Contact Features

Quick Disconnect Terminal Type	Tab
Mating Tab Width	6.35 mm[.25 in]
Mating Tab Thickness	.81 mm[.032 in]
Terminal Orientation	Straight
Contact Base Material	Brass
Terminal Plating Material	Tin
Crimp Type	F-Crimp



Barrel Type	Open
-------------	------

Mechanical Attachment

Mating Retention Type	Dimple
Wire Insulation Support	With

Dimensions

Accepts Wire Insulation Diameter Range	2.79 – 4.32 mm [.11 – .17 in]
Overall Length	20.57 mm [.81 in]
Receptacle Terminal Stock Thickness	.4 mm [.015 in]
Wire Size	2.1 – 3.31 mm ²

Usage Conditions

Insulation Option	Uninsulated
Operating Temperature Range	-40 – 110 °C [-40 – 230 °F]

Industry Standards

UL Rating	Recognized
CSA Certified	Yes

Packaging Features

Packaging Quantity	3000
Packaging Method	Strip/Reel

Product Compliance







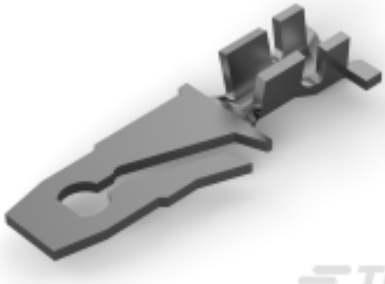

[For compliance documentation, visit the product page on TE.com>](#)

EU RoHS Directive 2011/65/EU	Compliant
EU ELV Directive 2000/53/EC	Compliant
China RoHS 2 Directive MIIT Order No 32, 2016	No Restricted Materials Above Threshold
EU REACH Regulation (EC) No. 1907/2006	Current ECHA Candidate List: JUNE 2022 (224) Candidate List Declared Against: JAN 2022 (223) SVHC > Threshold: Not Yet Reviewed
Halogen Content	Low Halogen - Br, Cl, F, I < 900 ppm per homogenous material. Also BFR/CFR/PVC Free
Solder Process Capability	Not applicable for solder process capability

Product Compliance Disclaimer

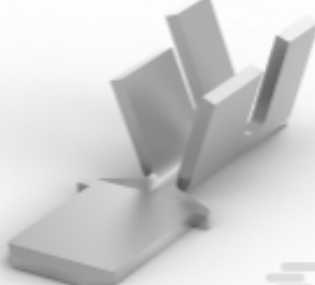
This information is provided based on reasonable inquiry of our suppliers and represents our current actual knowledge based on the information they provided. This information is subject to change. The part numbers that TE has identified as EU RoHS compliant have a maximum concentration of 0.1% by weight in homogenous materials for lead, hexavalent chromium, mercury, PBB, PBDE, DBP, BBP, DEHP, DIBP, and 0.01% for cadmium, or qualify for an exemption to these limits as defined in the Annexes of Directive 2011/65/EU (RoHS2). Finished electrical and electronic equipment products will be CE marked as required by Directive 2011/65/EU. Components may not be CE marked. Additionally, the part numbers that TE has identified as EU ELV compliant have a maximum concentration of 0.1% by weight in homogenous materials for lead, hexavalent chromium, and mercury, and 0.01% for cadmium, or qualify for an exemption to these limits as defined in the Annexes of Directive 2000/53/EC (ELV). Regarding the REACH Regulation, the information TE provides on SVHC in articles for this part number is based on the latest European Chemicals Agency (ECHA) 'Guidance on requirements for substances in articles' posted at this URL: <https://echa.europa.eu/guidance-documents/guidance-on-reach>

Compatible Parts

 <p>TE Part # 60794-2 FASTIN NECESSARY?? - separate GPL: 326</p>	 <p>TE Part # 63165-2 FASTON 110 AMPLIVAR TAB 23-19 MAG TPBR</p>	 <p>TE Part # 2305570-1 TERMINAL CUTTER, SIDE FEED</p>	 <p>TE Part # 1494210-2 110 FASTON,TAB,22-17 AWG, JIS C260</p>
 <p>TE Part # 1494210-1 110 FASTON,TAB,22-17 AWG, JIS C260</p>	 <p>TE Part # 180353-2 250 FASTON,TAB,12-10 AWG,TPBR</p>	 <p>TE Part # 180353-1 250 FASTON,TAB,12-10 AWG,BR</p>	 <p>TE Part # 180353-3 250 FASTON,TAB,12-10 AWG,TPBR</p>
 <p>TE Part # 2-2151771-1 OCEAN_2.0_Applicator-S-120F180F</p>	 <p>TE Part # 2-2151771-2 OCEAN_2.0_Applicator-S-120F180F</p>	 <p>TE Part # 2151771-1 OCEAN_2.0_Applicator-S-120F180F</p>	 <p>TE Part # 2151771-2 OCEAN_2.0_Applicator-S-120F180F</p>



Also in the Series | **FASTON 250**

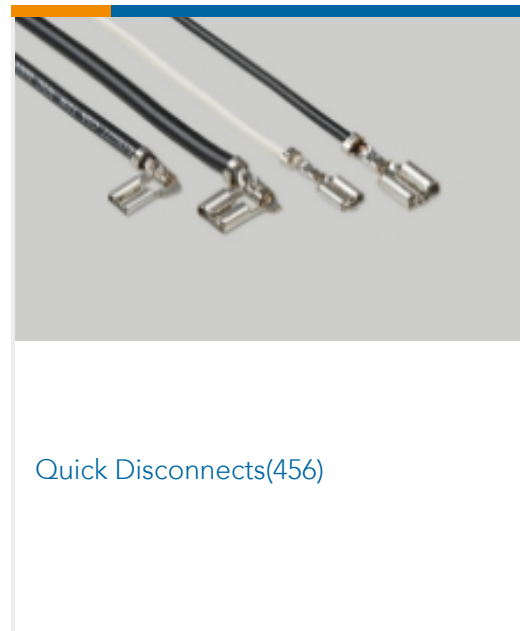
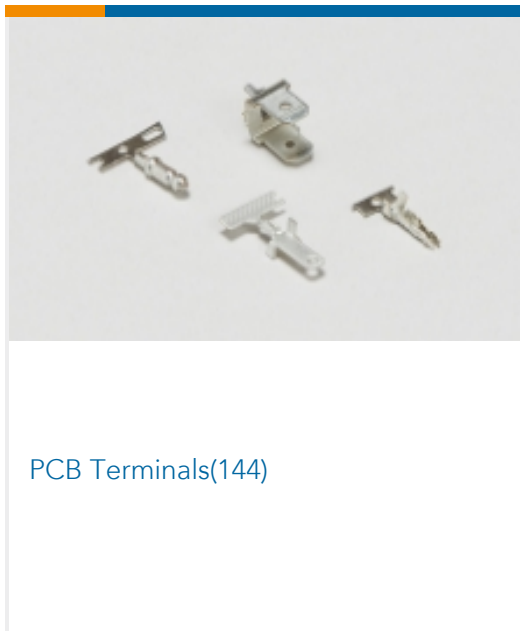
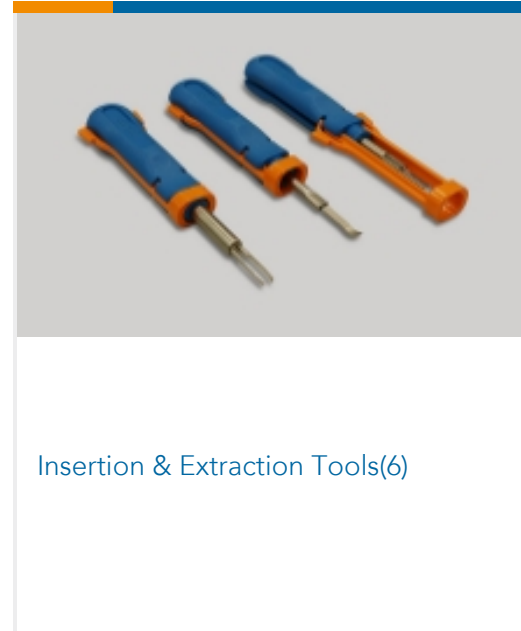
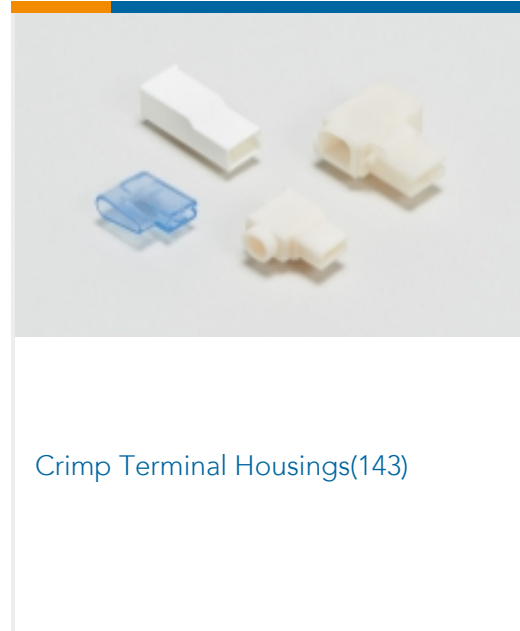
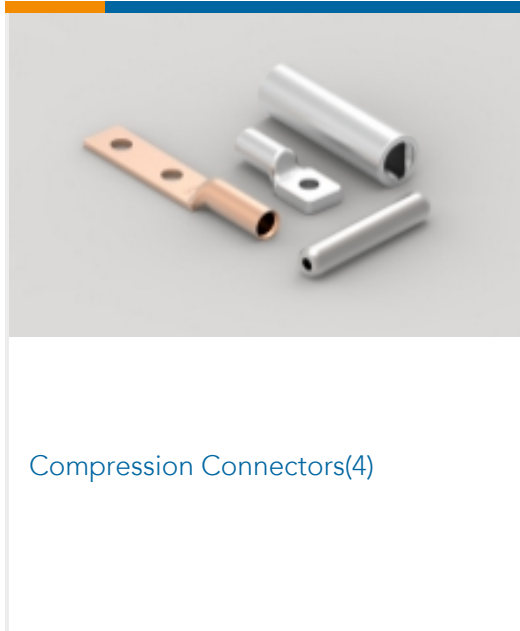

Customers Also Bought

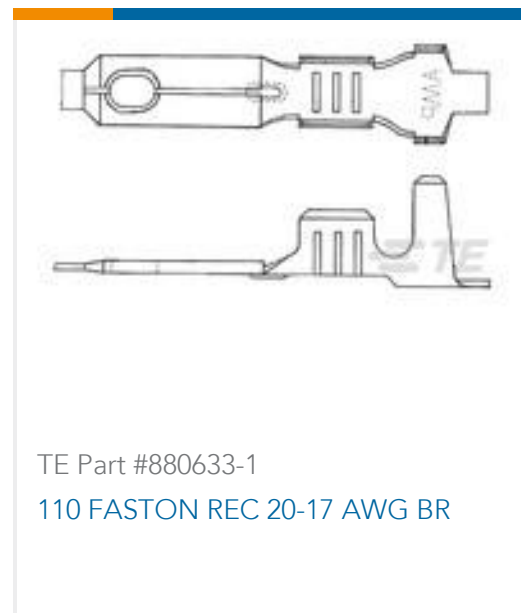



Documents

Product Drawings

250 FASTON TAB 14-12 AWG TPBR

English

CAD Files

3D PDF

3D

Customer View Model

[ENG_CVM_CVM_61281-3_V.2d_dxf.zip](#)

English

Customer View Model

[ENG_CVM_CVM_61281-3_V.3d_igs.zip](#)

English

Customer View Model

[ENG_CVM_CVM_61281-3_V.3d_stp.zip](#)

English

By downloading the CAD file I accept and agree to the [Terms and Conditions](#) of use.

Datasheets & Catalog Pages

FASTON Tabs

English

Product Specifications

EB**General Application Specification for Open Barrel Terminals

English

Application Specification

English

Product Environmental Compliance

[MD_61281-3_03182014335_dmtec](#)

English

[MD_61281-3_03182014335_dmtec](#)

English

Agency Approvals

CSA Certificate

English

CSA Certificate

English