

62056-6 ✓ ACTIVE

FASTON | FASTON 250

TE Internal #: 62056-6

Quick Disconnects, Receptacle, 18 – 12 AWG Wire Size, .82 – 3.31 mm² Wire Size, Mating Tab Width .25 in [6.35 mm], Flag, Phosphor Bronze, FASTON 250

[View on TE.com >](#)



Terminals & Splices > Quick Disconnects



Quick Disconnect Terminal Type: **Receptacle**

Wire Size: .82 – 3.31 mm²

Mating Tab Width: 6.35 mm [.25 in]

Mating Tab Thickness: .81 mm [.032 in]

Features

Product Type Features

Terminates To	Wire & Cable
Wire/Cable Type	Regular Wire
Wire Stop	No
Insertion Force	Low
Sealable	No

Configuration Features

Connection Capacity	Single
---------------------	--------

Contact Features

Quick Disconnect Terminal Type	Receptacle
Mating Tab Width	6.35 mm [.25 in]
Mating Tab Thickness	.81 mm [.032 in]
Terminal Orientation	Flag
Contact Base Material	Phosphor Bronze
Terminal Plating Material	Tin
Crimp Type	Tab-Lok



Barrel Type	Open
-------------	------

Mechanical Attachment

Mating Retention Type	Dimple
Wire Insulation Support	Without

Dimensions

Receptacle Terminal Stock Thickness	.41 mm[.016 in]
Overall Length	17.02 mm[.67 in]
Wire Size	.82 – 3.31 mm ²

Usage Conditions

Insulation Option	Uninsulated
Operating Temperature Range	-40 – 110 °C[-40 – 230 °F]

Industry Standards

CSA Certified	Yes
UL Rating	Listed

Packaging Features

Packaging Quantity	4000
Packaging Method	Strip/Reel

Other

Line	Premier
Comment	Right hand. Reverse reel.

Product Compliance

[For compliance documentation, visit the product page on TE.com>](#)

EU RoHS Directive 2011/65/EU	Compliant
EU ELV Directive 2000/53/EC	Compliant
China RoHS 2 Directive MIIT Order No 32, 2016	No Restricted Materials Above Threshold
EU REACH Regulation (EC) No. 1907/2006	Current ECHA Candidate List: JUNE 2022 (224) Candidate List Declared Against: JAN 2022 (223) SVHC > Threshold: Not Yet Reviewed
Halogen Content	Low Halogen - Br, Cl, F, I < 900 ppm per homogenous material. Also BFR/CFR/PVC

Free







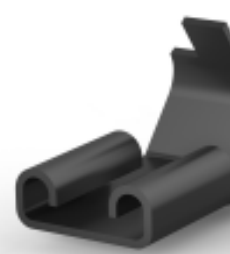
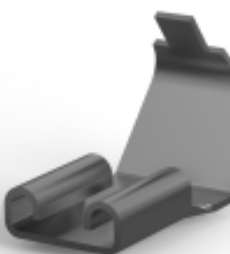

Solder Process Capability

Not applicable for solder process capability

Product Compliance Disclaimer

This information is provided based on reasonable inquiry of our suppliers and represents our current actual knowledge based on the information they provided. This information is subject to change. The part numbers that TE has identified as EU RoHS compliant have a maximum concentration of 0.1% by weight in homogenous materials for lead, hexavalent chromium, mercury, PBB, PBDE, DBP, BBP, DEHP, DIBP, and 0.01% for cadmium, or qualify for an exemption to these limits as defined in the Annexes of Directive 2011/65/EU (RoHS2). Finished electrical and electronic equipment products will be CE marked as required by Directive 2011/65/EU. Components may not be CE marked. Additionally, the part numbers that TE has identified as EU ELV compliant have a maximum concentration of 0.1% by weight in homogenous materials for lead, hexavalent chromium, and mercury, and 0.01% for cadmium, or qualify for an exemption to these limits as defined in the Annexes of Directive 2000/53/EC (ELV). Regarding the REACH Regulation, the information TE provides on SVHC in articles for this part number is based on the latest European Chemicals Agency (ECHA) 'Guidance on requirements for substances in articles' posted at this URL: <https://echa.europa.eu/guidance-documents/guidance-on-reach>

Compatible Parts

 <p>TE Part # 63555-2 250 FASTON FLAG REC 18-12 AWG TPBR</p>	 <p>TE Part # 62056-4 250 FASTON FLAG REC 18-12 AWG TPBR</p>	 <p>TE Part # 62057-8 250 FASTON FLAG REC 12-10 AWG TPBZ</p>	 <p>TE Part # 41800 250 FASTON FLAG REC 18-12 AWG TPBZ</p>
 <p>TE Part # 62056-3 250 FASTON FLAG REC 18-12 AWG TPBR</p>	 <p>TE Part # 62057-5 250 FASTON FLAG REC 12-10 AWG TPBZ</p>	 <p>TE Part # 63651-1 250 FASTON FLAG REC 18-12 AWG TPBZ</p>	 <p>TE Part # 62056-7 250 FASTON FLAG REC 18-12 AWG TPBZ</p>
 <p>TE Part # 60274-2 250 FASTON FLAG REC 18-12 AWG TPBZ</p>	 <p>TE Part # 62021-3 250 FASTON FLAG REC 12-10 AWB TPBR</p>	 <p>TE Part # 63517-1 250 FASTON FLAG REC 18-12 AWG TPBR</p>	

Also in the Series | **FASTON 250**



Compression Connectors(4)

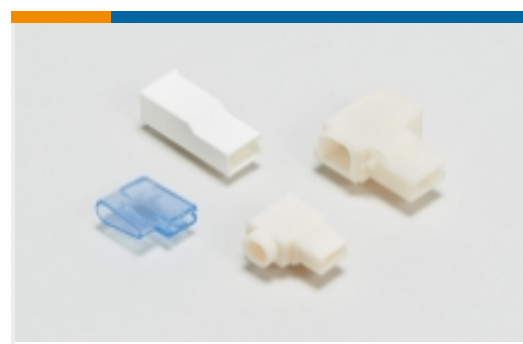

Crimp Terminal Housings(143)



Insertion & Extraction Tools(6)



Magnet Wire Terminals(1)



PCB Terminals(144)

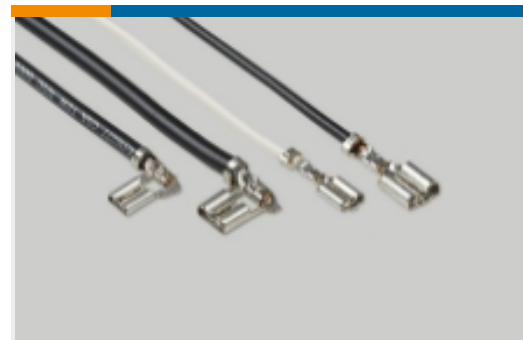

Quick Disconnects(456)



Splices(4)

Customers Also Bought

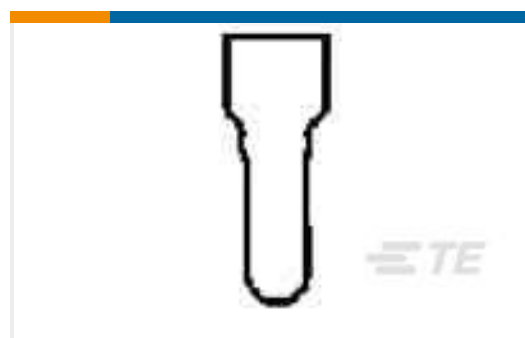

TE Part #53915-1
SPLICE,N CE 22-10

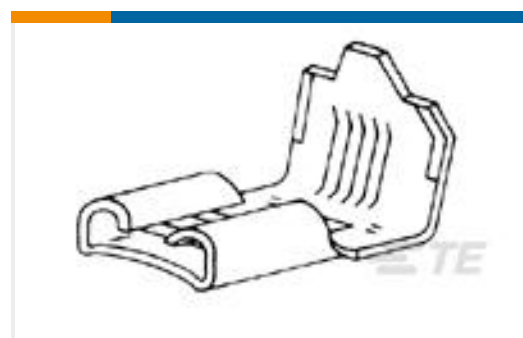

TE Part #62057-8
250 FASTON FLAG REC 12-10 AWG
TPBZ



TE Part #42742-2
250 FASTON FLAG REC 18-12 AWG
TPBR

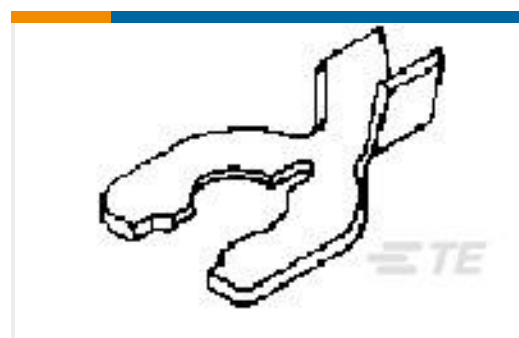

TE Part #63610-2
SPRING SPADE TERMINAL 14-10
AWG TPBR

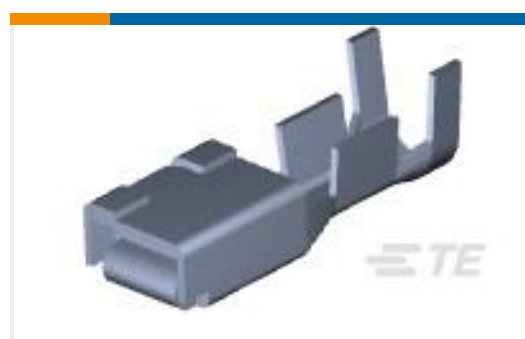

TE Part #179956-6
DYNAMIC D-5 REC M AG FORM

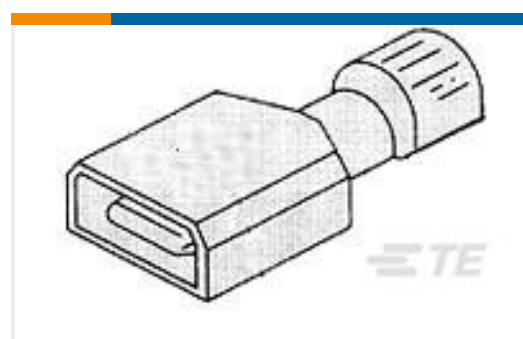

TE Part #2-521144-2
ULTRA-FAST 250 ASY TAB 22-18 TPBR



TE Part #2-520261-2
ULTRA-FAST 187 ASY REC 22-18 TPBR



TE Part #41274
250 FASTON,REC.,18-14 AWG,TPBR



TE Part #1742539-3
CLUSTER BLOCK RECEPT,TPCuFeP

Documents



Product Drawings

250 FASTON FLAG REC 18-12 AWG TPBZ

English

CAD Files

3D PDF

3D

Customer View Model

[ENG_CVM_CVM_62056-6_AL.2d_dxf.zip](#)

English

Customer View Model

[ENG_CVM_CVM_62056-6_AL.3d_igs.zip](#)

English

Customer View Model

[ENG_CVM_CVM_62056-6_AL.3d_stp.zip](#)

English

By downloading the CAD file I accept and agree to the [Terms and Conditions](#) of use.

Datasheets & Catalog Pages

82004 FASTON Terminals (Insulated and Uninsulated) Catalog - FASTON Receptacles Section

English

Product Specifications

Engineering Report

English