

640452-6 ✓ ACTIVE



MTA 100

TE Internal #: 640452-6

PCB Mount Header, Vertical, Wire-to-Board, 6 Position, .1 in [2.54 mm] Centerline, Unshrouded, Tin, Through Hole - Solder, Signal, Natural, MTA 100

[View on TE.com >](#)

Connectors > PCB Connectors > PCB Headers & Receptacles > Polyester Vertical PCB Header: 2.54mm, Unshrouded, No Mating Alignment



Connector System: **Wire-to-Board**

Number of Positions: **6**

Number of Rows: **1**

Centerline (Pitch): **2.54 mm [ .1 in ]**

PCB Mount Orientation: **Vertical**

[All Polyester Vertical PCB Header: 2.54mm, Unshrouded, No Mating Alignment \(332\)](#)

## Features

### Product Type Features

Connector System	Wire-to-Board
Header Type	Unshrouded
Sealable	No
Connector & Contact Terminates To	Printed Circuit Board
PCB Connector Assembly Type	PCB Mount Header

### Configuration Features

Number of Positions	6
Number of Rows	1
PCB Mount Orientation	Vertical

### Electrical Characteristics

Operating Voltage	250 VAC
-------------------	---------

### Body Features



Primary Product Color	Natural
-----------------------	---------

### Contact Features

Contact Layout	Inline
Contact Mating Area Length	7.49 mm[.295 in]
Mating Square Post Dimension	.64 mm[.025 in]
PCB Contact Termination Area Plating Material Thickness	3.81 $\mu$ m[150 $\mu$ in]
Contact Underplating Material Thickness	1.27 $\mu$ m[50 $\mu$ in]
Contact Mating Area Plating Material Thickness	3.81 $\mu$ m[150 $\mu$ in]
Contact Shape & Form	Square
Contact Mating Area Plating Material Finish	Matte
Contact Underplating Material	Nickel
PCB Contact Termination Area Plating Material	Tin
Contact Base Material	Copper Alloy
Contact Mating Area Plating Material	Tin
Contact Type	Pin
Contact Current Rating (Max)	5 A

### Termination Features

Square Termination Post & Tail Dimension	.64 mm[.025 in]
Termination Post & Tail Length	3.56 mm[.14 in]
Termination Method to Printed Circuit Board	Through Hole - Solder

### Mechanical Attachment

Mating Retention	Without
Panel Mount Feature	Without
Connector Mounting Type	Board Mount
Mating Alignment	Without
PCB Mount Alignment	Without
PCB Mount Retention	Without

### Housing Features

Housing Material	Polyester - GF
Centerline (Pitch)	2.54 mm[.1 in]

### Dimensions

Connector Length	17.78 mm[.7 in]
------------------	-----------------



Connector Height	2.54 mm[.1 in]
------------------	----------------

PCB Thickness (Recommended)	1.6 mm[.063 in]
-----------------------------	-----------------

### Usage Conditions

Operating Temperature Range	-55 – 105 °C[-67 – 221 °F]
-----------------------------	----------------------------

### Operation/Application

Circuit Application	Signal
---------------------	--------

### Industry Standards

CSA Rating	Certified
------------	-----------

Agency/Standard	CSA, UL
-----------------	---------

Approved Standards	CSA LR7189, UL E28476
--------------------	-----------------------

UL Flammability Rating	UL 94V-0
------------------------	----------

### Packaging Features

Packaging Quantity	1
--------------------	---

Packaging Type	Package
----------------	---------

### Product Compliance

[For compliance documentation, visit the product page on TE.com>](#)

EU RoHS Directive 2011/65/EU	Compliant
------------------------------	-----------

EU ELV Directive 2000/53/EC	Compliant
-----------------------------	-----------

China RoHS 2 Directive MIIT Order No 32, 2016	No Restricted Materials Above Threshold
---	---

EU REACH Regulation (EC) No. 1907/2006	Current ECHA Candidate List: JUNE 2022 (224) Candidate List Declared Against: JAN 2022 (223) SVHC > Threshold: Not Yet Reviewed
--	--

Halogen Content	Not Low Halogen - contains Br or Cl > 900 ppm.
-----------------	--

Solder Process Capability	Wave solder capable to 265°C
---------------------------	------------------------------

#### Product Compliance Disclaimer

This information is provided based on reasonable inquiry of our suppliers and represents our current actual knowledge based on the information they provided. This information is subject to change. The part numbers that TE has identified as EU RoHS compliant have a maximum concentration of 0.1% by weight in homogenous materials for lead, hexavalent chromium, mercury, PBB, PBDE, DBP, BBP, DEHP, DIBP, and 0.01% for cadmium, or qualify for an exemption to these limits as defined in the Annexes of Directive 2011/65/EU (RoHS2). Finished electrical and electronic equipment products will be CE marked as required by Directive 2011/65/EU. Components may not be CE marked. Additionally, the part numbers that TE has identified as EU ELV compliant have a maximum concentration of 0.1% by weight in homogenous materials for lead, hexavalent chromium, and mercury, and 0.01% for cadmium, or qualify for an exemption to these limits

as defined in the Annexes of Directive 2000/53/EC (ELV). Regarding the REACH Regulation, the information TE provides on SVHC in articles for this part number is based on the latest European Chemicals Agency (ECHA) 'Guidance on requirements for substances in articles' posted at this URL: <https://echa.europa.eu/guidance-documents/guidance-on-reach>

## Compatible Parts



TE Part # CAT-104MTA-NTPNR  
Nylon Tin Plated Receptacle: 2.54mm, No Mating Alignment, MTA 100



TE Part # CAT-104MTA-NTPMR  
Nylon Tin Plated Receptacle: 2.54mm, With Mating Alignment, MTA 100



TE Part # CAT-104MTA-PLSCC  
Polyester PCB Connector Covers: 2.54 mm, MTA 100



TE Part # CAT-104MTA-NYLCC  
Nylon PCB Connector Covers: 2.54 mm, MTA 100



TE Part # CAT-104CST-RCPHS  
Receptacle Housing: 2.54mm, 1 Row, CST-100 II



TE Part # 3-644315-6  
06P MTA100 CONN ASSY 26AWG

## Also in the Series | MTA 100



Insertion & Extraction Tools(2)



PCB Connector Covers(107)



PCB Connector Keying(1)



PCB Headers & Receptacles(1182)



Standard Rectangular Connectors (1718)

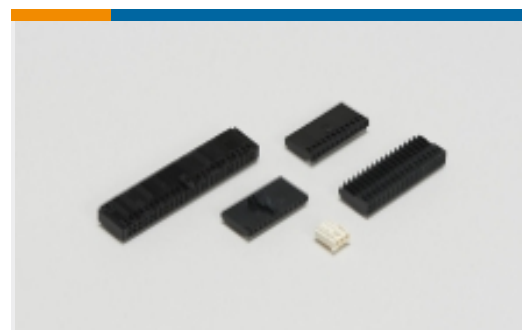

Wire-to-Board Connector Assemblies & Housings(1)



Wire-to-Board Connector Contacts(18)

## Customers Also Bought



TE Part #640452-3  
03P MTA100 HDR ASSY SQ STR

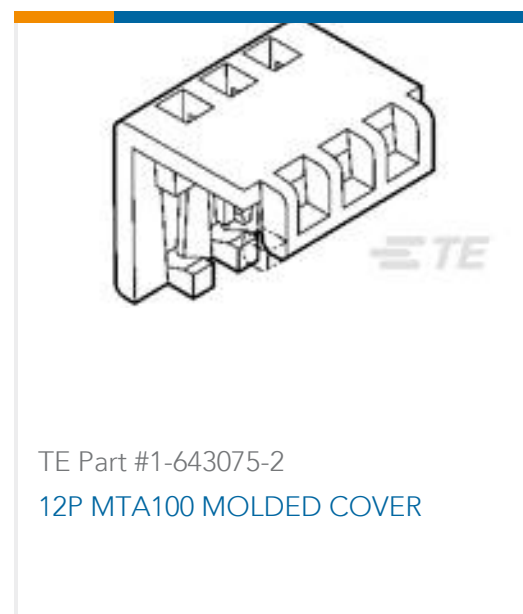

TE Part #1-643075-2  
12P MTA100 MOLDED COVER



TE Part #4-640441-4  
14P MTA100 CONN ASSY WHT



TE Part #1-746610-8  
34 DIP PLUG, 100CL, LEAD FREE



TE Part #1437539-5  
DIP Socket: Standard, Stamped & Formed, Open, Gold

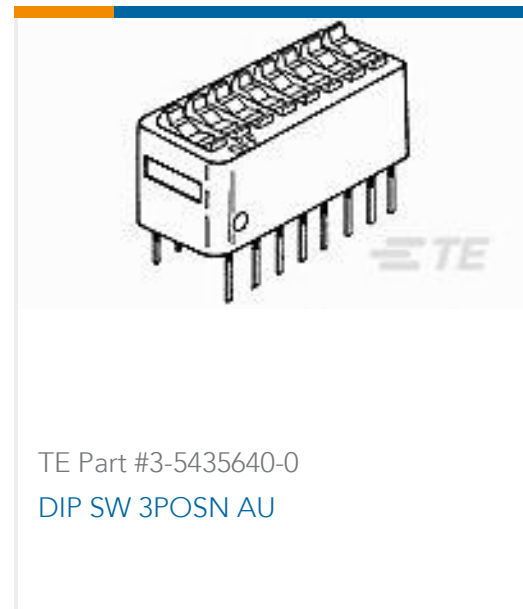

TE Part #3-5435640-0  
DIP SW 3POSN AU

## Documents

### Product Drawings

[06P MTA100 HDR ASSY SQ STR](#)

English

### CAD Files

[3D PDF](#)

3D

Customer View Model

[ENG\\_CVM\\_CVM\\_640452-6\\_AC.2d\\_dxf.zip](#)

English

Customer View Model

[ENG\\_CVM\\_CVM\\_640452-6\\_AC.3d\\_igs.zip](#)

English

Customer View Model

[ENG\\_CVM\\_CVM\\_640452-6\\_AC.3d\\_stp.zip](#)

English

[3D PDF](#)

English

Customer View Model

[ENG\\_CVM\\_640452-6\\_Z.2d\\_dxf.zip](#)

English

Customer View Model

[ENG\\_CVM\\_640452-6\\_Z.3d\\_igs.zip](#)

English

Customer View Model

[ENG\\_CVM\\_640452-6\\_Z.3d\\_stp.zip](#)

English



By downloading the CAD file I accept and agree to the [Terms and Conditions](#) of use.

---

### Datasheets & Catalog Pages

[MTA, CST-100 II, SL-156 and AMP Economy Power \(EP\) Connectors](#)

English

---

### Product Specifications

[Product Specification](#)

English

---

### Product Environmental Compliance

[MD\\_640452-6\\_08072017939\\_dmtec](#)

English

[MD\\_640452-6\\_08072017939\\_dmtec](#)

English

---

### Agency Approvals

[CSA Certificate](#)

English