

60774-1 ✓ ACTIVE

TE Internal #: 60774-1

Ring Terminals & Spade Terminals, Spade Tongue, 18 – 14 AWG

Wire Size, .8 – 2.08 mm² Wire Size, 1624 – 4106 CMA Wire Size,

Stud Size #8 / M4

[View on TE.com >](#)



Terminals & Splices > Ring Terminals & Spade Terminals



Ring & Spade Terminal Type: **Spade Tongue**

Wire Size: **1624 – 4106 CMA**

Stud Size: **#8, M4**

Features

Product Type Features

Shape Description	Square Spade
Stud Size	#8, M4
Sealable	No
Compatible With Discrete Wire Type	Stranded
Wire Insulation Support Retention Type	Insulation Support

Configuration Features

Terminal Angle	180 °
----------------	-------

Contact Features

Contact Base Material	Brass
Ring & Spade Terminal Type	Spade Tongue
Barrel Type	Open
Terminal Orientation	Straight
Terminal Plating Material	Unplated
Contact Underplating Material	None

Mechanical Attachment

Wire Insulation Support	With
-------------------------	------



Dimensions

	.1 in
Wire Size	1624 – 4106 CMA
Stud Diameter	4.17 mm[.164 in]
Tongue Thickness	.46 mm[.018 in]
Overall Product Length	20.32 mm[.8 in]
Barrel Inside Diameter	1.65 mm, 3.04 mm[.065 in][.12 in]
Accepts Wire Insulation Diameter (Max)	3.56 mm[.14 in]
Accepts Wire Insulation Diameter Range	2.54 – 3.56 mm[.1 – .14 in]

Usage Conditions

Insulation Option	Uninsulated
Operating Temperature Range	-40 – 110 °C[-40 – 230 °F]

Operation/Application

Compatible With Wire Base Material	Copper
Heavy Duty	No

Industry Standards

Government Qualified	No
----------------------	----

Packaging Features

Packaging Quantity	12000
Packaging Method	Strip/Reel

Product Compliance

[For compliance documentation, visit the product page on TE.com>](#)

EU RoHS Directive 2011/65/EU	Compliant
EU ELV Directive 2000/53/EC	Compliant
China RoHS 2 Directive MIIT Order No 32, 2016	No Restricted Materials Above Threshold
EU REACH Regulation (EC) No. 1907/2006	Current ECHA Candidate List: JUNE 2022 (224) Candidate List Declared Against: JAN 2022 (223) SVHC > Threshold: Not Yet Reviewed
Halogen Content	Low Halogen - Br, Cl, F, I < 900 ppm per homogenous material. Also BFR/CFR/PVC Free









Solder Process Capability

Not applicable for solder process capability

Product Compliance Disclaimer

This information is provided based on reasonable inquiry of our suppliers and represents our current actual knowledge based on the information they provided. This information is subject to change. The part numbers that TE has identified as EU RoHS compliant have a maximum concentration of 0.1% by weight in homogenous materials for lead, hexavalent chromium, mercury, PBB, PBDE, DBP, BBP, DEHP, DIBP, and 0.01% for cadmium, or qualify for an exemption to these limits as defined in the Annexes of Directive 2011/65/EU (RoHS2). Finished electrical and electronic equipment products will be CE marked as required by Directive 2011/65/EU. Components may not be CE marked. Additionally, the part numbers that TE has identified as EU ELV compliant have a maximum concentration of 0.1% by weight in homogenous materials for lead, hexavalent chromium, and mercury, and 0.01% for cadmium, or qualify for an exemption to these limits as defined in the Annexes of Directive 2000/53/EC (ELV). Regarding the REACH Regulation, the information TE provides on SVHC in articles for this part number is based on the latest European Chemicals Agency (ECHA) 'Guidance on requirements for substances in articles' posted at this URL: <https://echa.europa.eu/guidance-documents/guidance-on-reach>

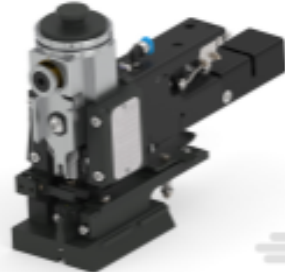
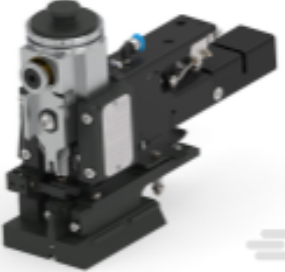
Compatible Parts

 <p>TE Part # 60390-1 SPADE CRIMP 20-16 AWG BR</p>	 <p>TE Part # 61498-1 SPADE 28-22 AWG .0157 X .310 BR</p>	 <p>TE Part # 7-2150380-7 OCEAN_2.0_SPARE_PART_KIT-110F160F</p>	 <p>TE Part # 2-2150380-1 OCEAN_2.0_APPLICATOR-E-110F160F</p>
 <p>TE Part # 2-2150380-2 OCEAN_2.0_APPLICATOR-E-110F160FA</p>	 <p>TE Part # 2-2150575-1 OCEAN_2.0_Applicator-E-110F160F</p>	 <p>TE Part # 2-2150575-2 OCEAN_2.0_Applicator-E-110F160F</p>	 <p>TE Part # 2150380-1 OCEAN_2.0_APPLICATOR-E-110F160F</p>
 <p>TE Part # 2150380-2 OCEAN_2.0_APPLICATOR-E-110F160FA</p>	 <p>TE Part # 2150575-1 OCEAN_2.0_Applicator-E-110F160F</p>	 <p>TE Part # 2150575-2 OCEAN_2.0_Applicator-E-110F160F</p>	 <p>TE Part # 7-2150380-1 OCEAN_2.0_APPLICATOR-E-110F160F</p>



Customers Also Bought

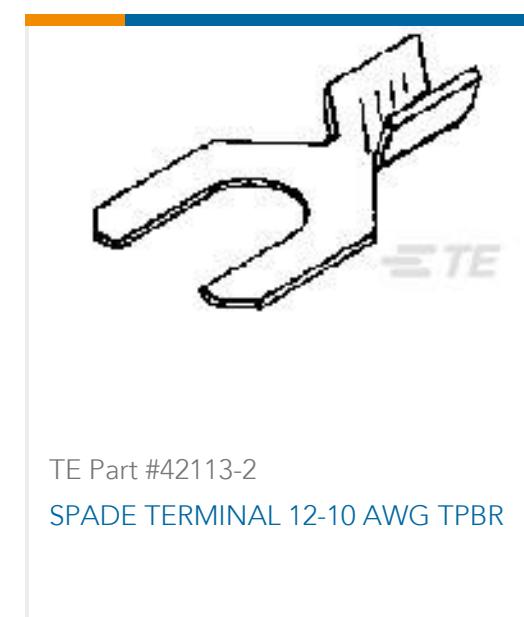
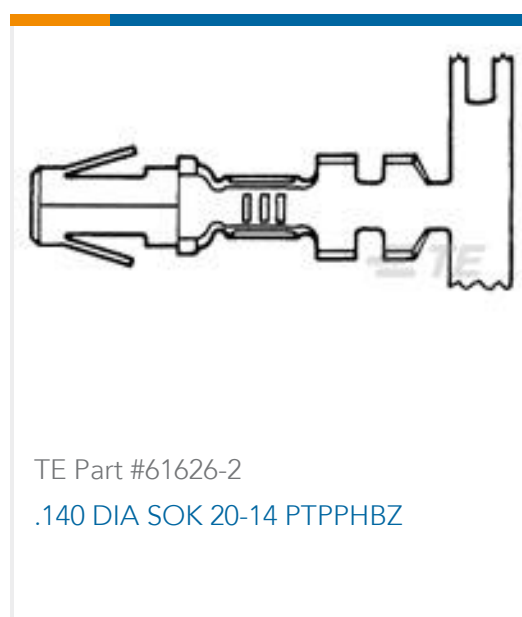
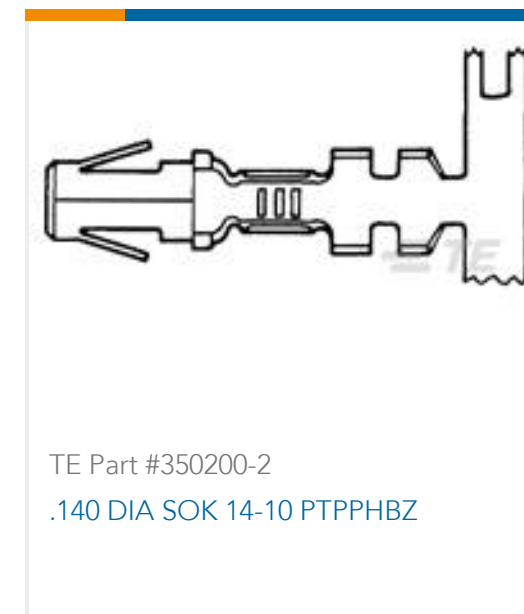
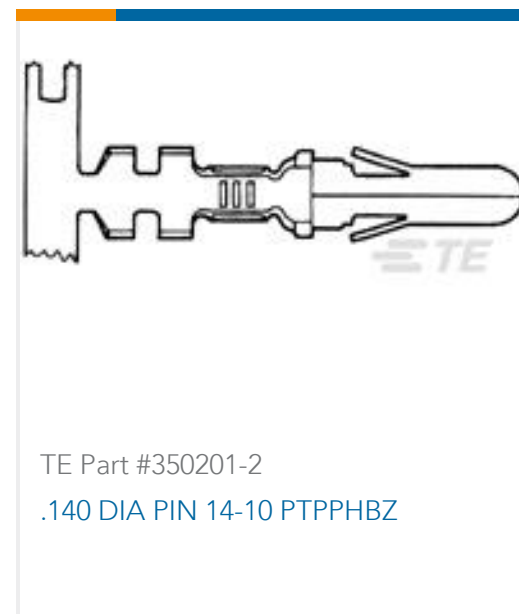
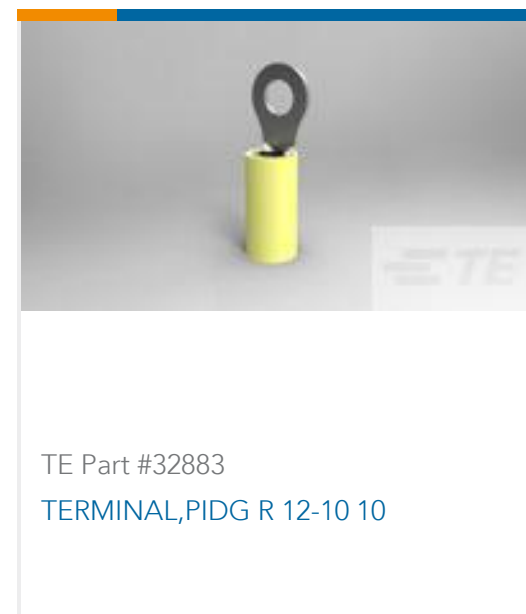

Documents

Product Drawings

SPADE TERMINAL 18-14 AWG BR

English

CAD Files

3D PDF

3D

Customer View Model

ENG_CVM_CVM_60774-1_K.2d_dxf.zip



English

Customer View Model

[ENG_CVM_CVM_60774-1_K.3d_igs.zip](#)

English

Customer View Model

[ENG_CVM_CVM_60774-1_K.3d_stp.zip](#)

English

By downloading the CAD file I accept and agree to the [Terms and Conditions](#) of use.

Product Specifications

[Application Specification](#)

English

Agency Approvals

[UL Report](#)

English