

60394-1 ✓ ACTIVE

TE Internal #: 60394-1

Ring Terminals & Spade Terminals, Ring Tongue, 20 – 16 AWG

Wire Size, .5 – 1.4 mm<sup>2</sup> Wire Size, 1021 – 2582 CMA Wire Size, Stud Size #10

[View on TE.com >](#)



Terminals & Splices > Ring Terminals & Spade Terminals

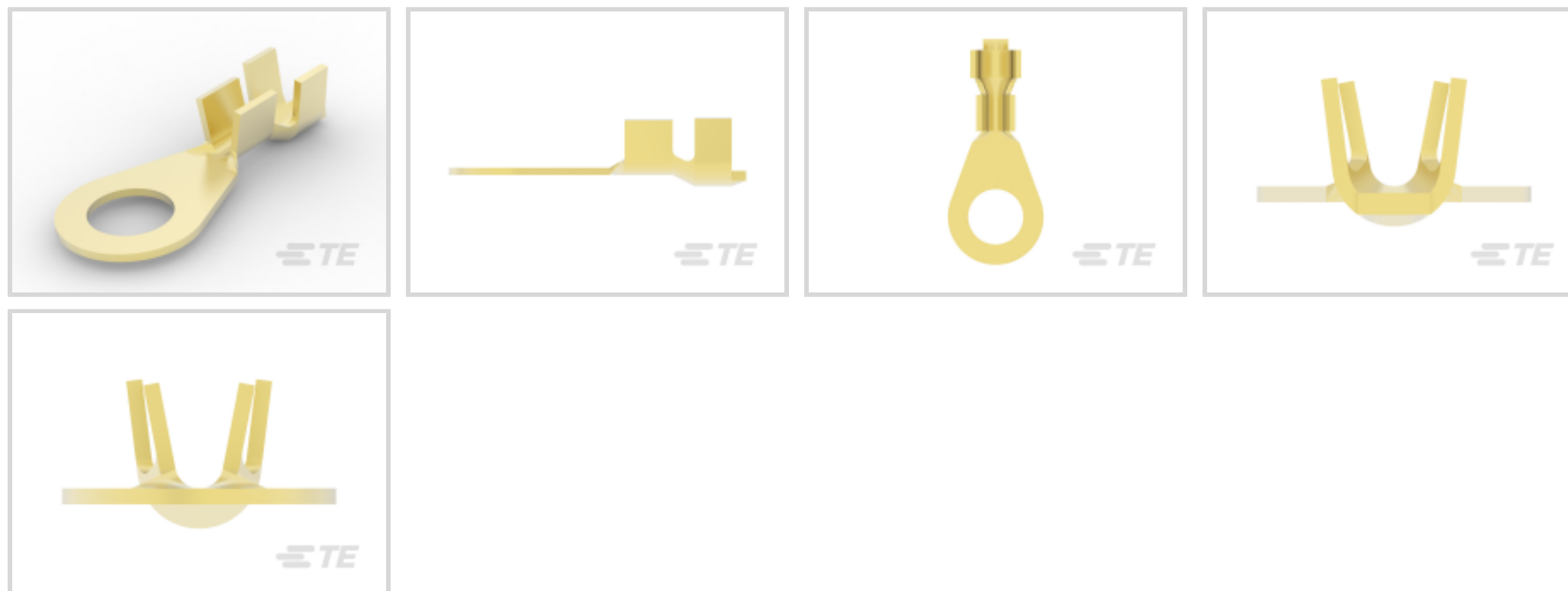

Ring & Spade Terminal Type: **Ring Tongue**

Wire Size: **1021 – 2582 CMA**

Stud Size: **#10**

## Features

### Product Type Features

Shape Description	Circular/Oval
Stud Size	#10
Sealable	No
Compatible With Discrete Wire Type	Stranded
Wire Insulation Support Retention Type	Insulation Support

### Configuration Features

Number of Holes	1
Terminal Angle	180 °

### Contact Features

Contact Base Material	Brass
Ring & Spade Terminal Type	Ring Tongue
Barrel Type	Open
Terminal Orientation	Straight
Terminal Plating Material	Unplated
Contact Underplating Material	None

### Mechanical Attachment



Wire Insulation Support	With
-------------------------	------

### Dimensions

	.11 in
Wire Size	1021 – 2582 CMA
Stud Diameter	5 mm[.19 in][.197 in]
Tongue Thickness	.51 mm[.02 in]
Overall Product Length	19.3 mm[.76 in]
Barrel Inside Diameter	1.52 mm, 2.92 mm[.06 in][.115 in]
Accepts Wire Insulation Diameter (Max)	3.56 mm[.14 in]
Accepts Wire Insulation Diameter Range	2.54 – 3.56 mm[.11 – .14 in]

### Usage Conditions

Insulation Option	Uninsulated
Operating Temperature Range	-40 – 110 °C[-40 – 230 °F]

### Operation/Application

Compatible With Wire Base Material	Copper
Heavy Duty	No

### Industry Standards

Government Qualified	No
----------------------	----

### Packaging Features

Packaging Quantity	7000
Packaging Method	Strip/Reel

### Product Compliance

[For compliance documentation, visit the product page on TE.com>](#)

EU RoHS Directive 2011/65/EU	Compliant
EU ELV Directive 2000/53/EC	Compliant
China RoHS 2 Directive MIIT Order No 32, 2016	No Restricted Materials Above Threshold
EU REACH Regulation (EC) No. 1907/2006	Current ECHA Candidate List: JUNE 2022 (224) Candidate List Declared Against: JAN 2022 (223) SVHC > Threshold: Not Yet Reviewed
Halogen Content	Low Halogen - Br, Cl, F, I < 900 ppm per

homogenous material. Also BFR/CFR/PVC Free













Solder Process Capability

Not applicable for solder process capability

Product Compliance Disclaimer

This information is provided based on reasonable inquiry of our suppliers and represents our current actual knowledge based on the information they provided. This information is subject to change. The part numbers that TE has identified as EU RoHS compliant have a maximum concentration of 0.1% by weight in homogenous materials for lead, hexavalent chromium, mercury, PBB, PBDE, DBP, BBP, DEHP, DIBP, and 0.01% for cadmium, or qualify for an exemption to these limits as defined in the Annexes of Directive 2011/65/EU (RoHS2). Finished electrical and electronic equipment products will be CE marked as required by Directive 2011/65/EU. Components may not be CE marked. Additionally, the part numbers that TE has identified as EU ELV compliant have a maximum concentration of 0.1% by weight in homogenous materials for lead, hexavalent chromium, and mercury, and 0.01% for cadmium, or qualify for an exemption to these limits as defined in the Annexes of Directive 2000/53/EC (ELV). Regarding the REACH Regulation, the information TE provides on SVHC in articles for this part number is based on the latest European Chemicals Agency (ECHA) 'Guidance on requirements for substances in articles' posted at this URL: <https://echa.europa.eu/guidance-documents/guidance-on-reach>

## Compatible Parts

 <p>TE Part # 40725 RING 190(4.82MM)TERMINAL 18-14 AWG TPBR</p>	 <p>TE Part # 40955 RING 20-16 AWG .0295 X .390 TPBR</p>	 <p>TE Part # 40661 RING 190(4.82 MM) TERMINAL 18-14 AWG BR</p>	 <p>TE Part # 40660 RING 164(4.17 MM) TERMINAL 18-14 AWG BR</p>
 <p>TE Part # 60390-1 SPADE CRIMP 20-16 AWG BR</p>	 <p>TE Part # 40725-1 RING TONGUE TERMINAL 18-14 AWG TPPHBZ</p>	 <p>TE Part # 190225-2 RING I/S PRE TIN BRASS</p>	 <p>TE Part # 60389-1 SPADE CRIMP 20-16 AWG BR</p>
 <p>TE Part # 1217730-1 RING TERMINAL (RT) 18-14 AWG BR</p>	 <p>TE Part # 2-2150734-2 OCEAN-2.0-APPLICATOR-E-110F1550</p>	 <p>TE Part # 2150734-2 OCEAN-2.0-APPLICATOR-E-110F1550</p>	 <p>TE Part # 60235-1 RING 18-14 AWG BR</p>



## Customers Also Bought

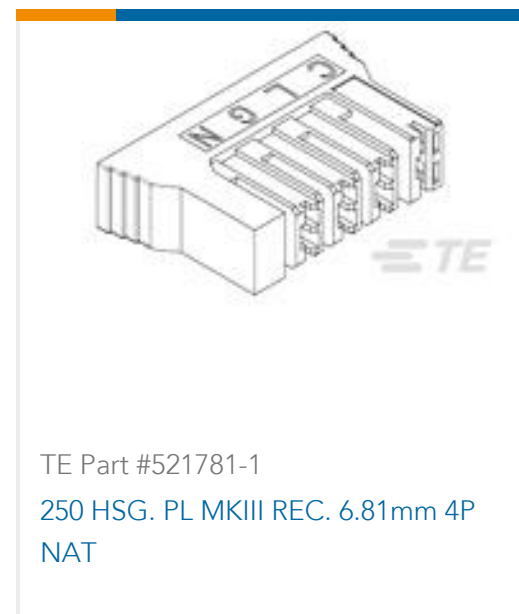

## Documents

### Product Drawings

[RING TERMINAL 20-16 AWG BR](#)

English

### CAD Files

[3D PDF](#)

[3D](#)

[Customer View Model](#)

[ENG\\_CVM\\_CVM\\_60394-1\\_W\\_c-60394-1-w.2d\\_dxf.zip](#)



English

**Customer View Model**

[ENG\\_CVM\\_CVM\\_60394-1\\_W\\_c-60394-1-w.3d\\_igs.zip](#)

English

**Customer View Model**

[ENG\\_CVM\\_CVM\\_60394-1\\_W\\_c-60394-1-w.3d\\_stp.zip](#)

English

By downloading the CAD file I accept and agree to the [Terms and Conditions](#) of use.

---

**Product Specifications**

**Application Specification**

English

---

**Product Environmental Compliance**

[MD\\_60394-1\\_06122018521\\_dmtec](#)

English

[MD\\_60394-1\\_06122018521\\_dmtec](#)

English

---

**Agency Approvals**

**UL Report**

English