

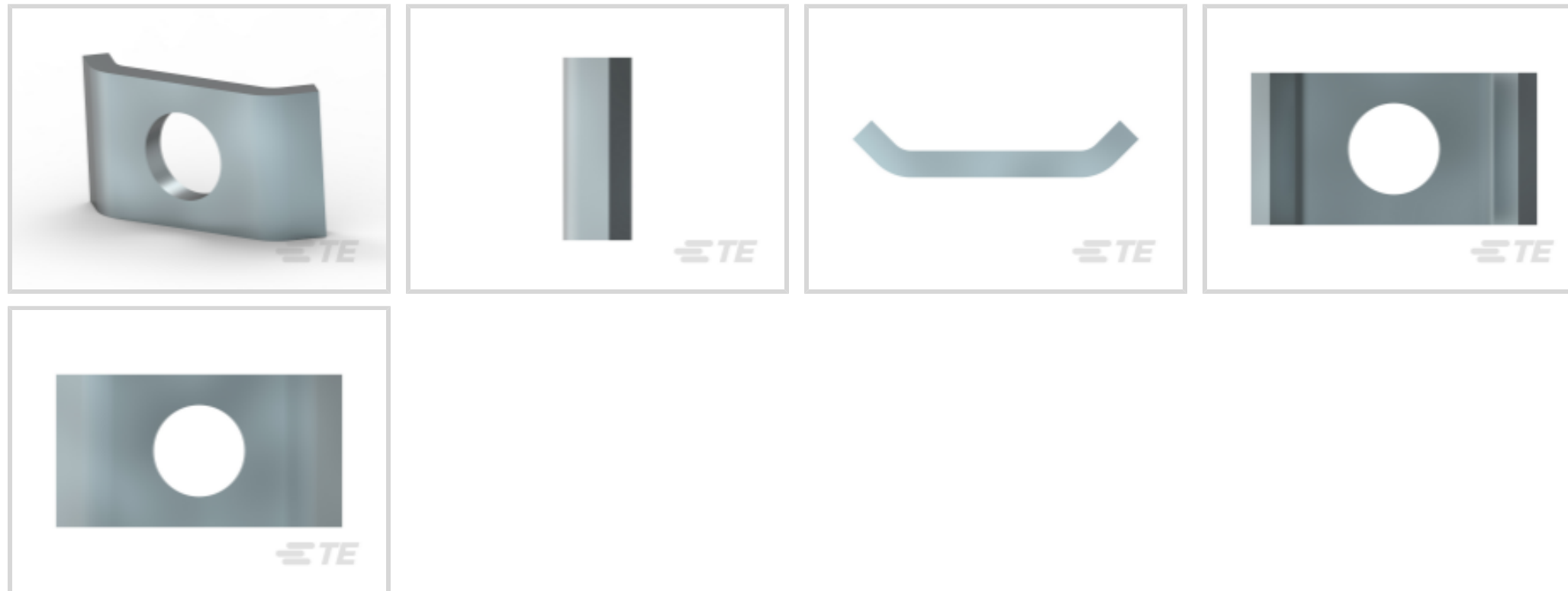

Connectors > D-Shaped Connectors > D-Sub Accessories > Locking & Mounting



D-Shaped Connector Accessories: **Saddle Washer**

Features

Product Type Features

Product Type	Accessory
D-Shaped Connector Accessories	Saddle Washer

Mechanical Attachment

Screw Finish	Clear Chromate
Screw & Hole Thread Size	4-40

Operation/Application

For Use With	Mounting Screw 5206052-3
--------------	--------------------------

Packaging Features

Packaging Quantity	1
Packaging Method	Package

Product Compliance

[For compliance documentation, visit the product page on TE.com>](#)

EU RoHS Directive 2011/65/EU	Compliant
EU ELV Directive 2000/53/EC	Compliant
China RoHS 2 Directive MIIT Order No 32, 2016	No Restricted Materials Above Threshold
EU REACH Regulation (EC) No. 1907/2006	Current ECHA Candidate List: JUNE 2022 (224)



Candidate List Declared Against: JAN 2022
(223)
SVHC > Threshold:
Not Yet Reviewed

Halogen Content	Low Halogen - Br, Cl, F, I < 900 ppm per homogenous material. Also BFR/CFR/PVC Free
-----------------	---

Solder Process Capability	Not applicable for solder process capability
---------------------------	--

Product Compliance Disclaimer

This information is provided based on reasonable inquiry of our suppliers and represents our current actual knowledge based on the information they provided. This information is subject to change. The part numbers that TE has identified as EU RoHS compliant have a maximum concentration of 0.1% by weight in homogenous materials for lead, hexavalent chromium, mercury, PBB, PBDE, DBP, BBP, DEHP, DIBP, and 0.01% for cadmium, or qualify for an exemption to these limits as defined in the Annexes of Directive 2011/65/EU (RoHS2). Finished electrical and electronic equipment products will be CE marked as required by Directive 2011/65/EU. Components may not be CE marked. Additionally, the part numbers that TE has identified as EU ELV compliant have a maximum concentration of 0.1% by weight in homogenous materials for lead, hexavalent chromium, and mercury, and 0.01% for cadmium, or qualify for an exemption to these limits as defined in the Annexes of Directive 2000/53/EC (ELV). Regarding the REACH Regulation, the information TE provides on SVHC in articles for this part number is based on the latest European Chemicals Agency (ECHA) 'Guidance on requirements for substances in articles' posted at this URL: <https://echa.europa.eu/guidance-documents/guidance-on-reach>

Compatible Parts

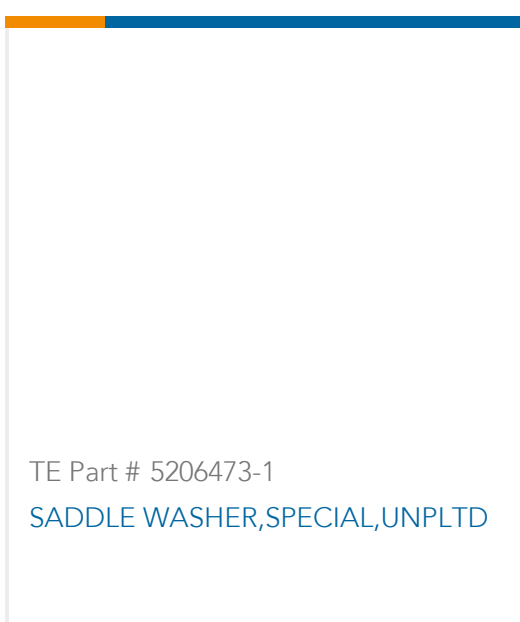

Also in the Series | AMPLIMITE Kit

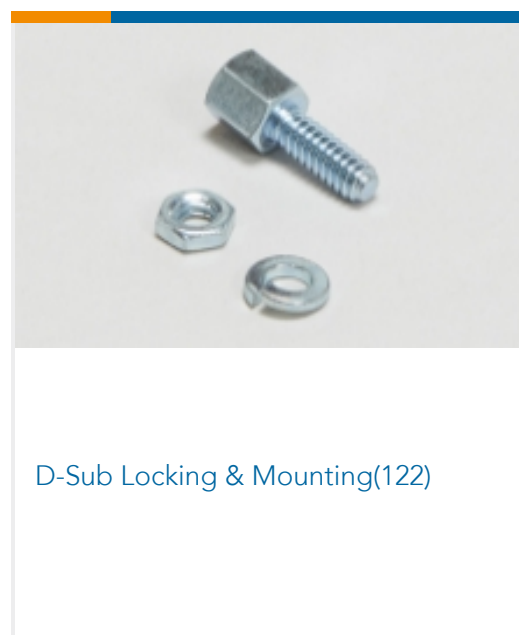
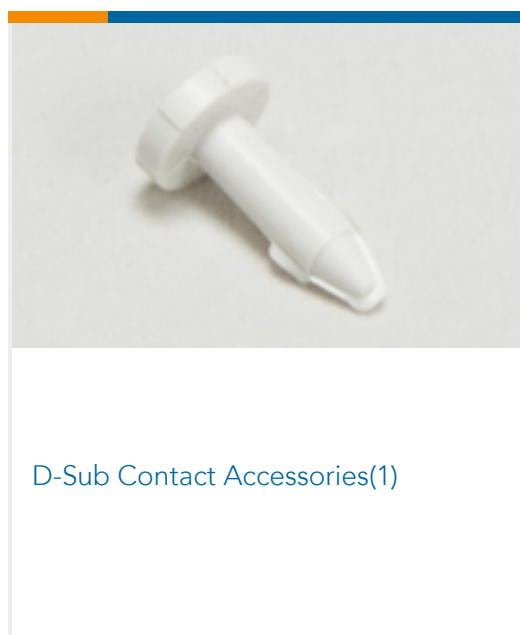

Customers Also Bought

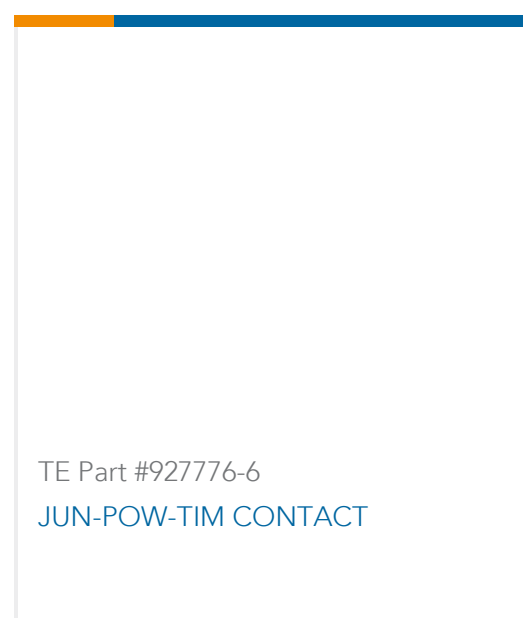
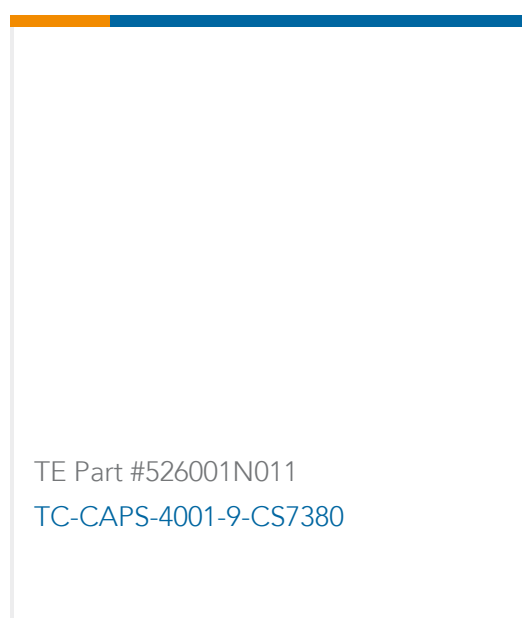
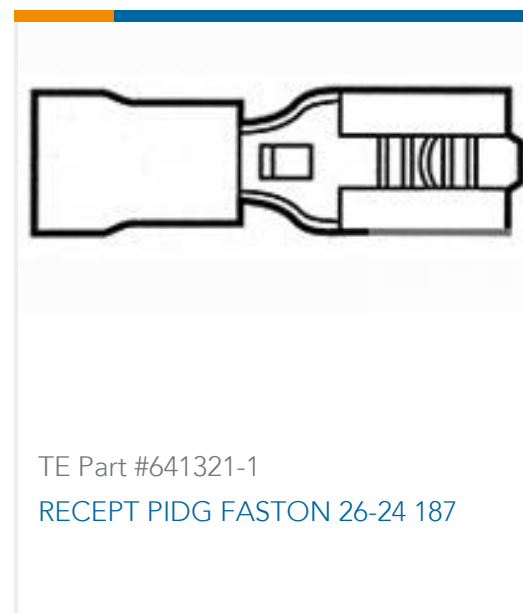

Documents

Product Drawings

SADDLE WASHER,SPECIAL,ZN PLTD

English

CAD Files

Customer View Model

[ENG_CVM_CVM_5206473-3_O.2d_dxf.zip](#)

English

3D PDF

3D

Customer View Model

[ENG_CVM_CVM_5206473-3_O.3d_igs.zip](#)

English

Customer View Model

[ENG_CVM_CVM_5206473-3_O.3d_stp.zip](#)

English

By downloading the CAD file I accept and agree to the [Terms and Conditions](#) of use.

Product Environmental Compliance



TE Material Declaration

English

Instruction Sheets

Instruction Sheet (U.S.)

English