

52936-2 ✓ ACTIVE



PIDG

TE Internal #: 52936-2

Ring Terminals & Spade Terminals, Spring Spade, 16 – 14 AWG

Wire Size, 1.25 – 2 mm² Wire Size, 2050 – 5180 CMA Wire Size, Stud

Size #8 / M4, PIDG

[View on TE.com >](#)

Terminals & Splices > Ring Terminals & Spade Terminals > PIDG LONG SPRING SPADE TONGUE TERMINALS

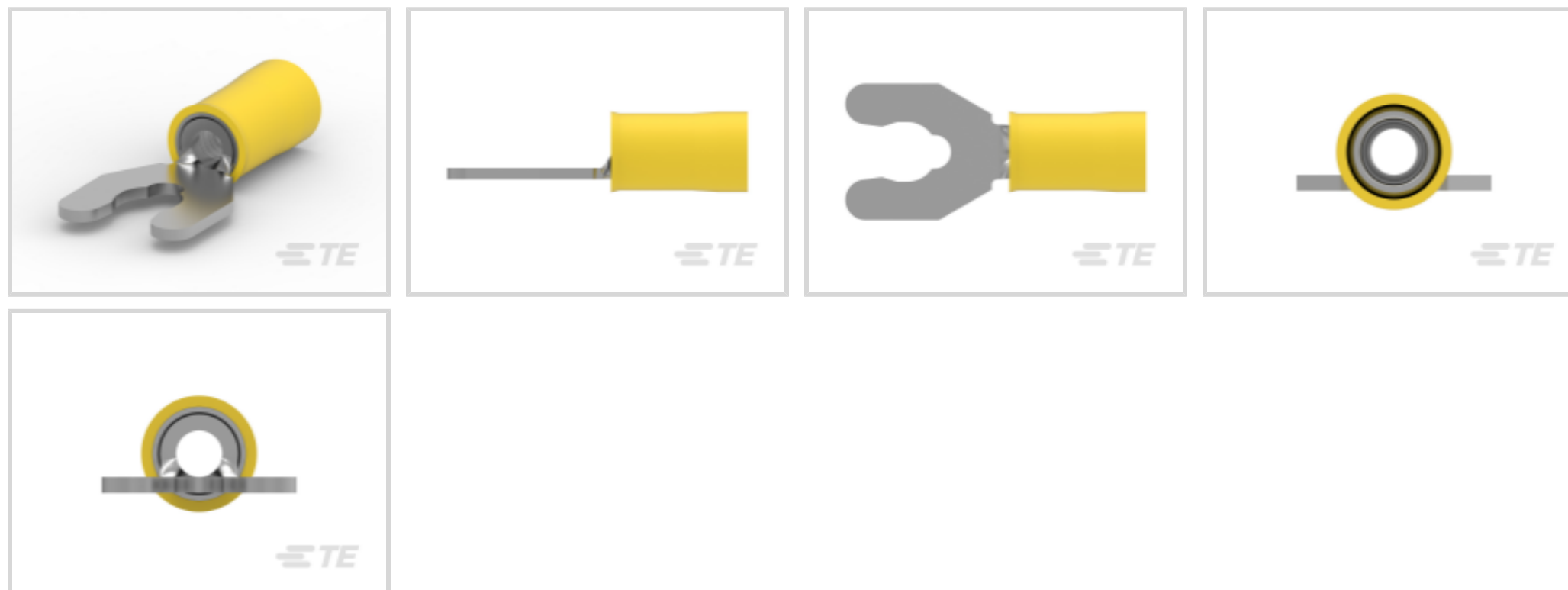

Ring & Spade Terminal Type: **Spring Spade**

Wire Size: **2050 – 5180 CMA**

Stud Size: **#8, M4**

[All PIDG LONG SPRING SPADE TONGUE TERMINALS \(52\)](#)

Features

Product Type Features

Shape Description	SPADE-028
Stud Size	#8, M4
Sealable	No
Wire Insulation Support Retention Type	Insulation Support

Configuration Features

Terminal Angle	180 °
----------------	-------

Electrical Characteristics

Voltage (Max)	300 V
---------------	-------

Body Features

Inspection Slot	No
Insulation Sleeve Color	Blue
Stripe Color	Blue

Contact Features

--	--

Ring & Spade Terminal Type	Spring Spade
Barrel Type	Closed
Terminal Orientation	Offset
Terminal Plating Material	Tin

Mechanical Attachment

Wire Insulation Support	With
-------------------------	------

Dimensions

Wire Size	2050 – 5180 CMA
Stud Diameter	4.17 mm[.164 in]
Tongue Thickness	.79 mm[.031 in]
Overall Product Length	21.84 mm[.86 in]
Accepts Wire Insulation Diameter (Max)	4.62 mm[.182 in]
Accepts Wire Insulation Diameter Range	2.92 – 4.62 mm[.115 – .182 in]

Usage Conditions

Insulation Option	Partially Insulated
Operating Temperature Range	105 °C[221 °F]

Operation/Application

Compatible With Wire Base Material	Copper
Compatible With Wire Plating Material	Tin
Heavy Duty	No

Industry Standards

Government Qualified	No
----------------------	----

Packaging Features

Packaging Quantity	1000
Packaging Method	Loose Piece

Product Compliance

[For compliance documentation, visit the product page on TE.com>](#)

EU RoHS Directive 2011/65/EU	Compliant
EU ELV Directive 2000/53/EC	Compliant
China RoHS 2 Directive MIIT Order No 32, 2016	No Restricted Materials Above Threshold
EU REACH Regulation (EC) No. 1907/2006	



Current ECHA Candidate List: JUNE 2022 (224)
 Candidate List Declared Against: JUNE 2022 (224)
 Does not contain REACH SVHC

Halogen Content

Low Halogen - Br, Cl, F, I < 900 ppm per homogenous material. Also BFR/CFR/PVC Free

Solder Process Capability

Not applicable for solder process capability

Product Compliance Disclaimer

This information is provided based on reasonable inquiry of our suppliers and represents our current actual knowledge based on the information they provided. This information is subject to change. The part numbers that TE has identified as EU RoHS compliant have a maximum concentration of 0.1% by weight in homogenous materials for lead, hexavalent chromium, mercury, PBB, PBDE, DBP, BBP, DEHP, DIBP, and 0.01% for cadmium, or qualify for an exemption to these limits as defined in the Annexes of Directive 2011/65/EU (RoHS2). Finished electrical and electronic equipment products will be CE marked as required by Directive 2011/65/EU. Components may not be CE marked. Additionally, the part numbers that TE has identified as EU ELV compliant have a maximum concentration of 0.1% by weight in homogenous materials for lead, hexavalent chromium, and mercury, and 0.01% for cadmium, or qualify for an exemption to these limits as defined in the Annexes of Directive 2000/53/EC (ELV). Regarding the REACH Regulation, the information TE provides on SVHC in articles for this part number is based on the latest European Chemicals Agency (ECHA) 'Guidance on requirements for substances in articles' posted at this URL: <https://echa.europa.eu/guidance-documents/guidance-on-reach>

Compatible Parts

TE Part # 59824-1
TETRA-CRIMP PIDG PG FASTON 22-10 ASSY

TE Part # 58433-3
PRO CR ASSY, RBY IS9252

TE Part # 59250
T-HEAD PIDG 26-14 ASSY

TE Part # 47387
DAHT PG PIDG 20-14 ASSY

TE Part # 58423-1
DIE, RBY IS9252

TE Part # 47387-7
DAHT PG PIDG 16-12 ASSY

TE Part # 525691
DAHT PG PIDG 16-14 ASSY

TE Part # 539691-2
ERGO DIE R.B.Y



Also in the Series | PIDG

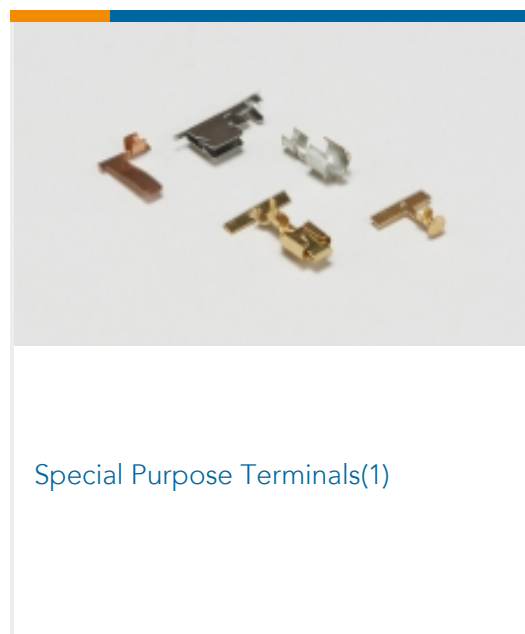
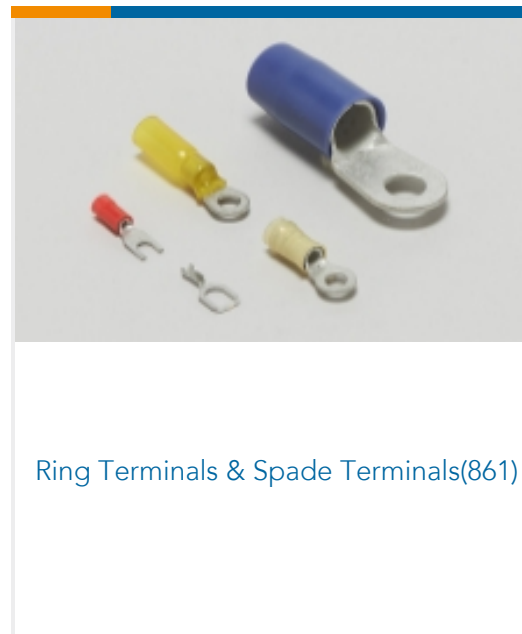
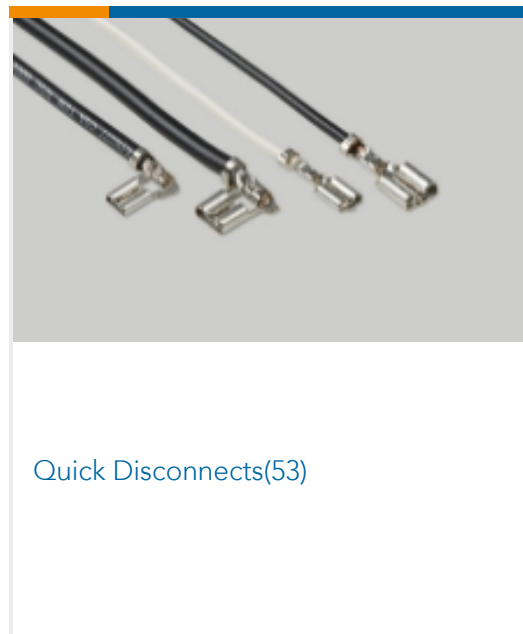
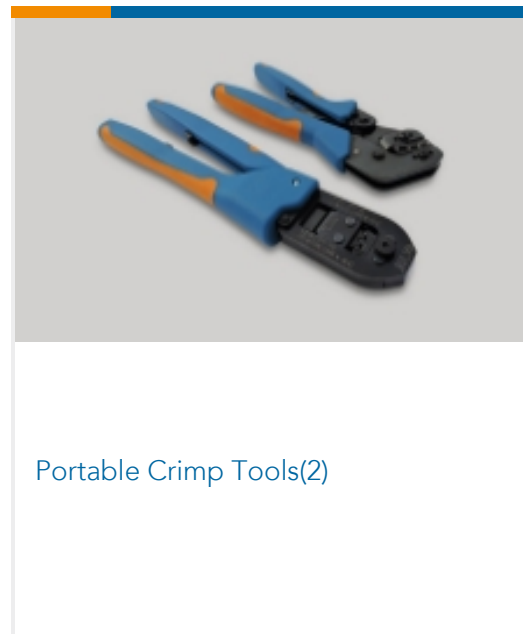
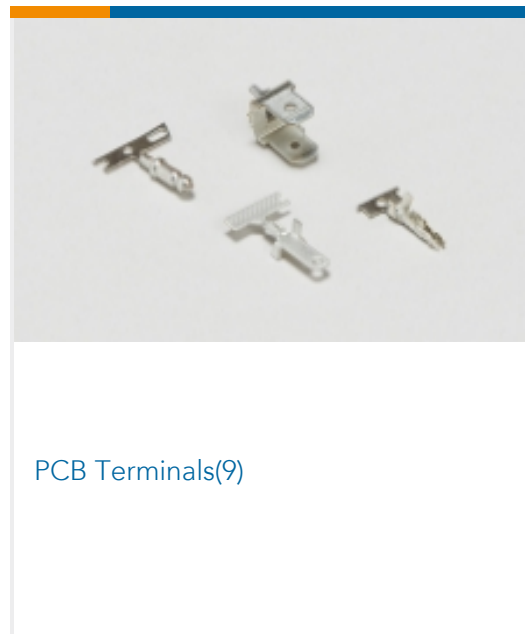
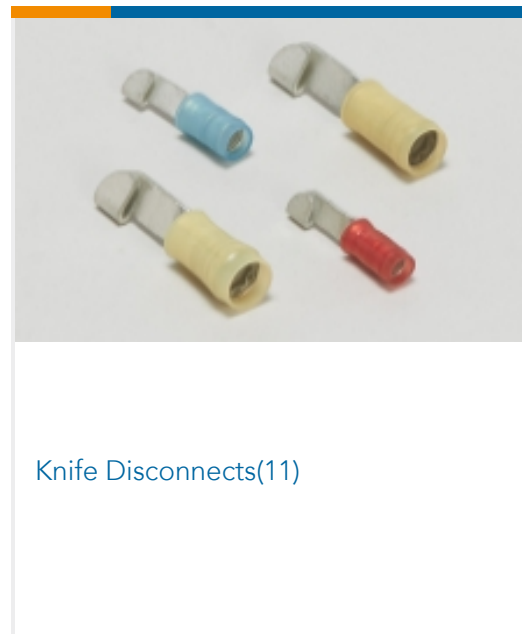
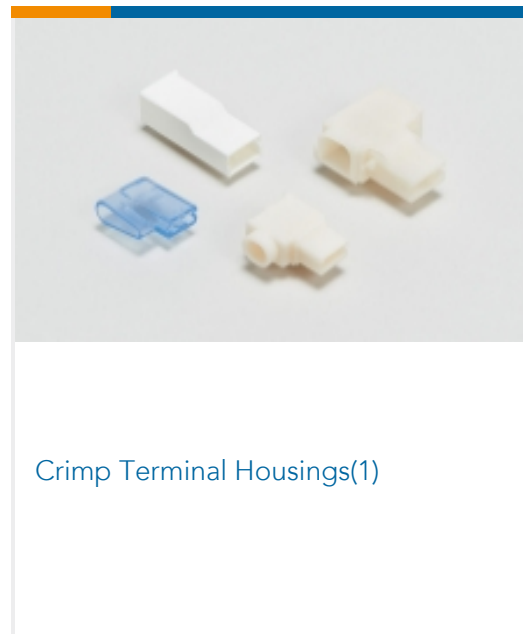
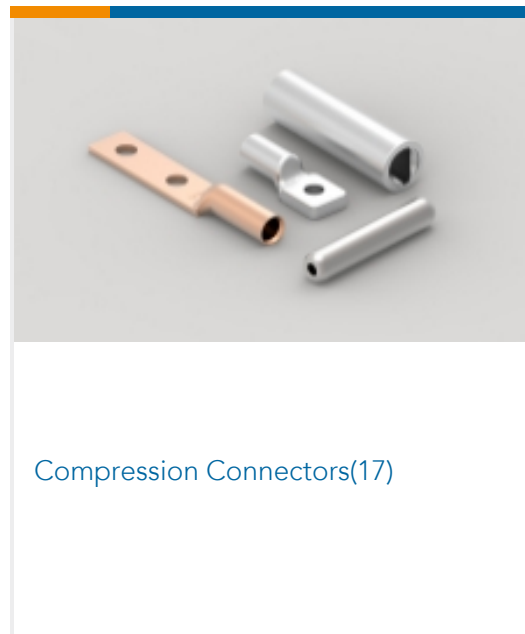

Customers Also Bought



TE Part #327583
SPLICE BUTT PIDG 16-14/22-18

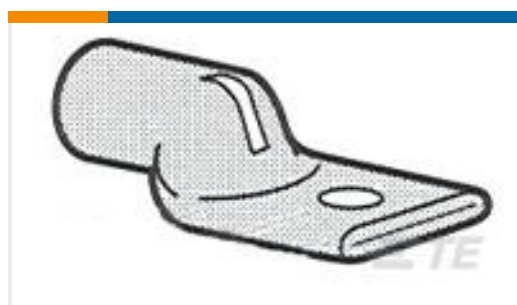

TE Part #328142
TERMINAL,AMPOWER 6 1/4



TE Part #794215-1
24P MINI UMNL2 CAP HSG UL94V0



TE Part #1-794222-0
MINI UMNL2 PIN 20-16AWG AU LF



TE Part #794222-1
MINI UMNL2 PIN 20-16AWG SN



TE Part #326804
TERMINAL,AMPOWER 250MCM 3/8



TE Part #57040-4
Madison Spec 100-4703 Rev. 7

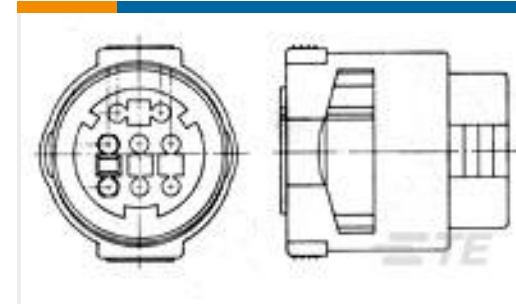

TE Part #172198-1
ECONOSEAL-J CONN PLUG 2P



TE Part #322252
TERM,SOLIS R 250-300MCM 3/8



TE Part #322254
TERM,SOLIS R 250-300MCM 1/2

Documents

Product Drawings

[TERMINAL,PIDG SPR SPD 16-14 8](#)

English

CAD Files

[3D PDF](#)

3D

Customer View Model

[ENG_CVM_CVM_52936-2_V.2d_dxf.zip](#)

English

Customer View Model

[ENG_CVM_CVM_52936-2_V.3d_igs.zip](#)

English

Customer View Model

[ENG_CVM_CVM_52936-2_V.3d_stp.zip](#)

English

Customer View Model

[ENG_CVM_52936-2_K.3d_igs.zip](#)

English



Customer View Model

[ENG_CVM_52936-2_K.3d_stp.zip](#)

English

Customer View Model

[ENG_CVM_52936-2_K.2d_dxf.zip](#)

English

3D PDF

English

By downloading the CAD file I accept and agree to the [Terms and Conditions](#) of use.

Product Specifications

[Application Specification](#)

English

Product Environmental Compliance

[Product Compliance](#)

English

[Product Compliance](#)

English

Instruction Sheets

[AMP* PIDG* \(VINYL\) & PLASTI-GRIP* SHORT SPRING SPADE TERMINALS FOR BAR](#)

English

[Instruction Sheet \(U.S.\)](#)

English

Agency Approvals

[UL Report](#)

English