

51864-4 ✓ ACTIVE



PIDG

TE Internal #: 51864-4

Ring Terminals & Spade Terminals, Ring Tongue, 16 – 14 AWG

Wire Size, 1.31 – 2.08 mm² Wire Size, 2050 – 5180 CMA Wire Size,

Stud Size #10

[View on TE.com >](#)

Terminals & Splices > Ring Terminals & Spade Terminals > PIDG RING TONGUE TERMINALS

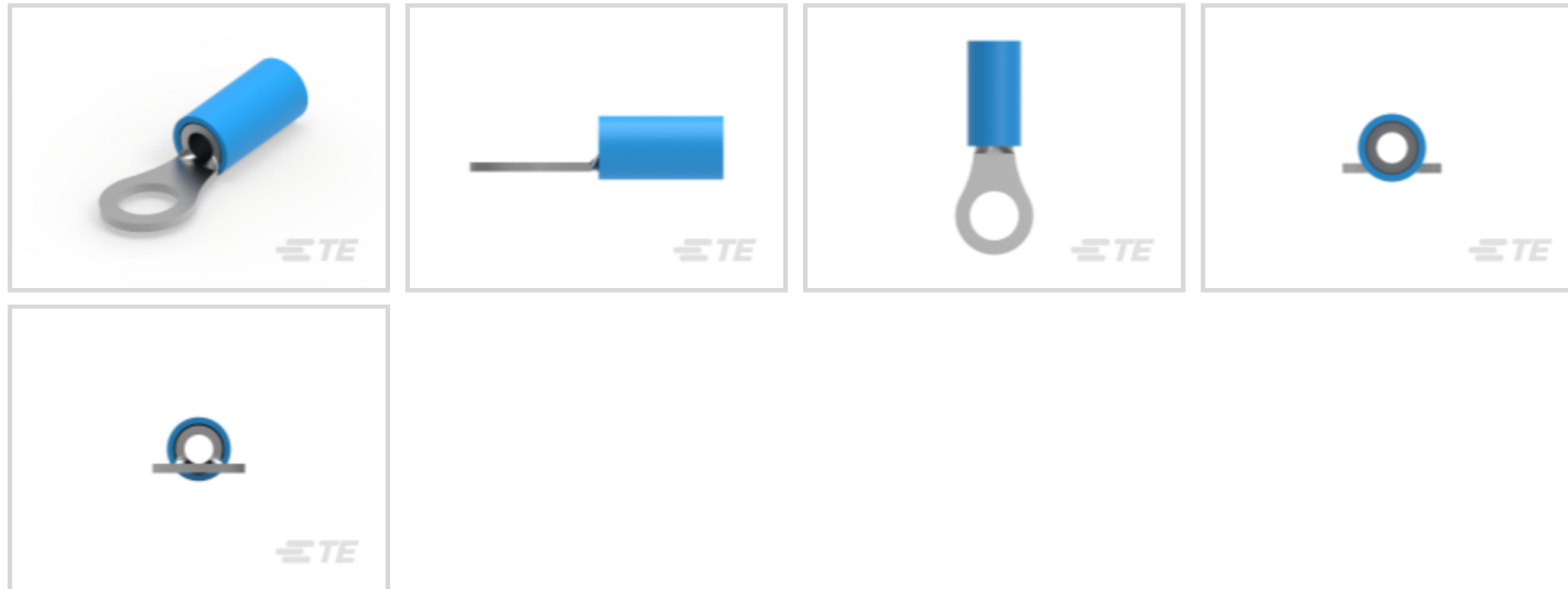

Ring & Spade Terminal Type: **Ring Tongue**

Wire Size: **2050 – 5180 CMA**

Stud Size: **#10**

[All PIDG RING TONGUE TERMINALS \(421\)](#)

Features

Product Type Features

Shape Description	RING-041
Stud Size	#10
Sealable	No
Wire Insulation Support Retention Type	Insulation Support

Configuration Features

Number of Holes	1
Terminal Angle	180 °

Electrical Characteristics

Voltage (Max)	300 V
---------------	-------

Body Features

Insulation Sleeve Color	Blue
Weight per Piece	.967 g
Stripe Color	Blue

Contact Features

Ring & Spade Terminal Type	Ring Tongue
Barrel Type	Closed
Terminal Orientation	Offset
Terminal Plating Material	Tin

Mechanical Attachment

Wire Insulation Support	With
-------------------------	------

Dimensions

Wire Size	2050 – 5180 CMA
Stud Diameter	5 mm[.197 in]
Tongue Thickness	.79 mm[.031 in]
Overall Product Length	21.44 mm[.844 in]
Accepts Wire Insulation Diameter (Max)	3.81 mm[.15 in]
Accepts Wire Insulation Diameter Range	2.67 – 3.81 mm[.105 – .15 in]

Usage Conditions

Insulation Option	Partially Insulated
Operating Temperature Range	105 °C[221 °F]

Operation/Application

Compatible With Wire Base Material	Copper
Compatible With Wire Plating Material	Tin
Heavy Duty	No

Industry Standards

Government Qualified	No
----------------------	----

Packaging Features

Packaging Quantity	5000
Packaging Method	Tape Mounted

Product Compliance

[For compliance documentation, visit the product page on TE.com>](#)

EU RoHS Directive 2011/65/EU	Compliant
EU ELV Directive 2000/53/EC	Compliant
China RoHS 2 Directive MIIT Order No 32, 2016	No Restricted Materials Above Threshold
EU REACH Regulation (EC) No. 1907/2006	

Current ECHA Candidate List: JUNE 2022 (224)
 Candidate List Declared Against: JUNE 2022 (224)
 Does not contain REACH SVHC







Halogen Content	Low Halogen - Br, Cl, F, I < 900 ppm per homogenous material. Also BFR/CFR/PVC Free
-----------------	---

Solder Process Capability	Not applicable for solder process capability
---------------------------	--

Product Compliance Disclaimer

This information is provided based on reasonable inquiry of our suppliers and represents our current actual knowledge based on the information they provided. This information is subject to change. The part numbers that TE has identified as EU RoHS compliant have a maximum concentration of 0.1% by weight in homogenous materials for lead, hexavalent chromium, mercury, PBB, PBDE, DBP, BBP, DEHP, DIBP, and 0.01% for cadmium, or qualify for an exemption to these limits as defined in the Annexes of Directive 2011/65/EU (RoHS2). Finished electrical and electronic equipment products will be CE marked as required by Directive 2011/65/EU. Components may not be CE marked. Additionally, the part numbers that TE has identified as EU ELV compliant have a maximum concentration of 0.1% by weight in homogenous materials for lead, hexavalent chromium, and mercury, and 0.01% for cadmium, or qualify for an exemption to these limits as defined in the Annexes of Directive 2000/53/EC (ELV). Regarding the REACH Regulation, the information TE provides on SVHC in articles for this part number is based on the latest European Chemicals Agency (ECHA) 'Guidance on requirements for substances in articles' posted at this URL: <https://echa.europa.eu/guidance-documents/guidance-on-reach>

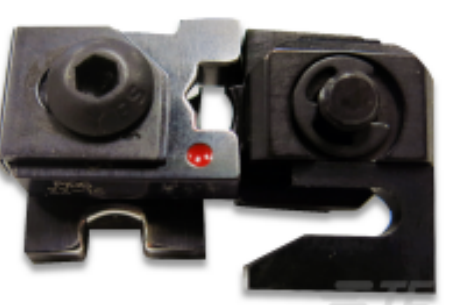
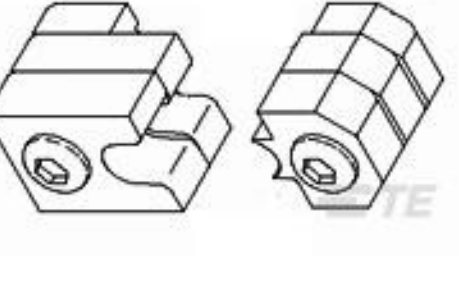
Compatible Parts

 <p>TE Part # 59824-1 TETRA-CRIMP PIDG PG FASTON 22-10 ASSY</p>	 <p>TE Part # 58433-3 PRO CR ASSY, RBY IS9252</p>	 <p>TE Part # 47387 DAHT PG PIDG 20-14 ASSY</p>	 <p>TE Part # 58423-1 DIE, RBY IS9252</p>
 <p>TE Part # 55823-1 RBY PRO CRIMPER KIT</p>	 <p>TE Part # 47806-2 DIES PIDG 22-16 DIE SET</p>	 <p>TE Part # 47807-1 DIES PIDG 16-14 DIE SET</p>	 <p>TE Part # 1SET191002R0000 TET CRIMP-HT</p>



TE Part # 169404
CERTI-LOK DIE

Also in the Series | PIDG



Compression Connectors(17)



Crimp Terminal Housings(1)



Crimp Wire Pins, Tabs & Ferrules(41)



Knife Disconnects(11)



PCB Terminals(9)



Portable Crimp Tools(2)

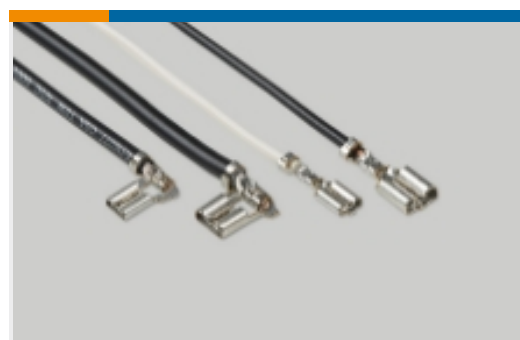

Quick Disconnects(53)



Ring Terminals & Spade Terminals(861)



Special Purpose Terminals(1)



Splices(48)

Customers Also Bought

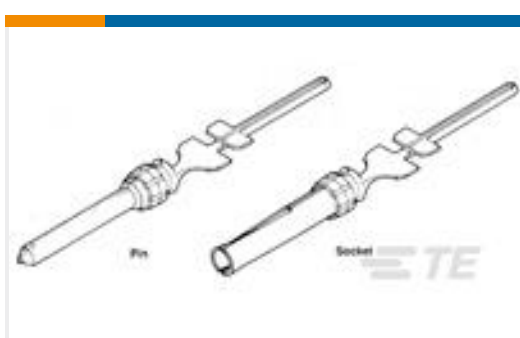

TE Part #5-745288-8
20 DF SKT CONTACT DUPLEX/LP



TE Part #60812-1
BRUSH CONTACT 18-14 AWG PHBZ

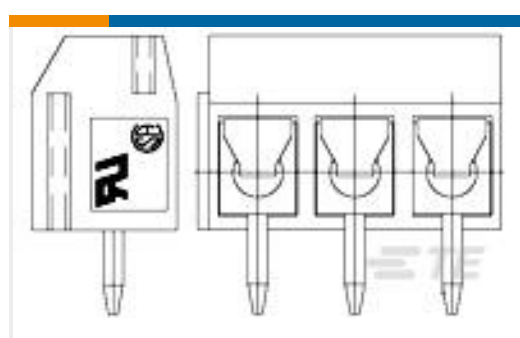

TE Part #1776244-6
Vert Side Wire Entry, 5.0mm, B



TE Part #2-31807-3
TERMINAL, SOLIS R 8 10

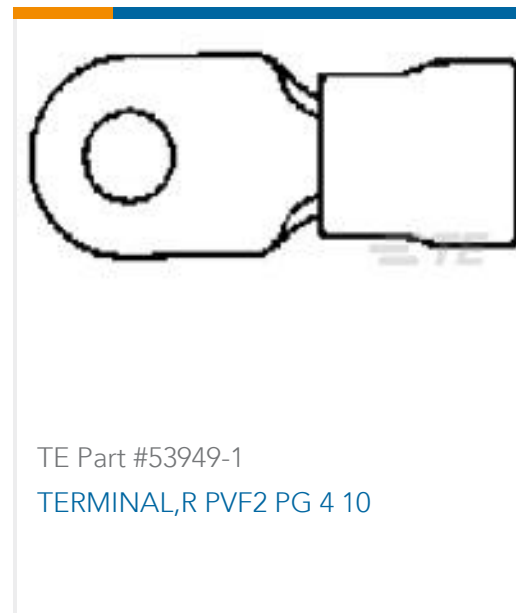
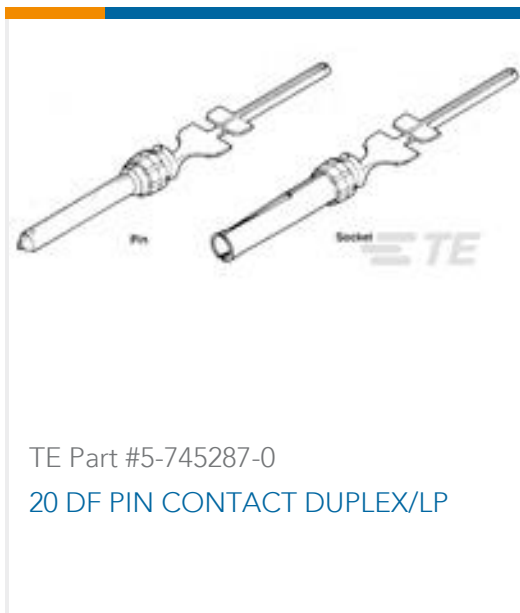

Documents

Product Drawings

[TERMINAL,PIDG R 16-14 10](#)

English

CAD Files

Customer View Model

[ENG_CVM_CVM_51864-4_AF.2d_dxf.zip](#)

English

Customer View Model

[ENG_CVM_CVM_51864-4_AF.3d_igs.zip](#)

English

Customer View Model

[ENG_CVM_CVM_51864-4_AF.3d_stp.zip](#)

English

[3D PDF](#)

3D

By downloading the CAD file I accept and agree to the [Terms and Conditions](#) of use.

Product Specifications

[Application Specification](#)

English

Product Environmental Compliance

[MD_51864-4_080120181446_dmtec](#)

English

[MD_51864-4_080120181446_dmtec](#)

English

Agency Approvals

[UL Report](#)

English