

5223985-1 ✓ ACTIVE

Z-PACK 2mm HM

TE Internal #: 5223985-1

Backplane Guide Hardware, Guide Pin, Z-PACK 2mm HM

[View on TE.com >](#)



Connectors > PCB Connectors > Backplane Connectors > Backplane Guide Hardware



Backplane Guide Hardware Type: **Guide Pin**

Features

Product Type Features

Backplane Guide Hardware Type	Guide Pin
-------------------------------	-----------

Configuration Features

PCB Mount Orientation	Vertical
-----------------------	----------

Body Features

Guide Component Plating Material Finish Process	Chromate Conversion Coating
Guide Component Base Material	Zinc Alloy Die Casting

Contact Features

Contact Mating Area Plating Material	Zinc Alloy
--------------------------------------	------------

Termination Features

Compatible With Backplane Interface Type	2mm HM
--	--------

Mechanical Attachment

Guide Hardware	With
----------------	------

Dimensions

Thread Length	6 mm [.236 in]
---------------	----------------

Packaging Features

Packaging Method	Box
------------------	-----

Other

Comment

Overall length: 31.48 [1.24].

Product Compliance

[For compliance documentation, visit the product page on TE.com>](#)

EU RoHS Directive 2011/65/EU

Compliant

EU ELV Directive 2000/53/EC

Compliant

China RoHS 2 Directive MIIT Order No 32, 2016

No Restricted Materials Above Threshold

EU REACH Regulation (EC) No. 1907/2006

Current ECHA Candidate List: JUNE 2022 (224)
 Candidate List Declared Against: JAN 2022 (223)
 SVHC > Threshold:
 Not Yet Reviewed

Halogen Content

Low Halogen - Br, Cl, F, I < 900 ppm per homogenous material. Also BFR/CFR/PVC Free

Solder Process Capability

Not applicable for solder process capability

Product Compliance Disclaimer

This information is provided based on reasonable inquiry of our suppliers and represents our current actual knowledge based on the information they provided. This information is subject to change. The part numbers that TE has identified as EU RoHS compliant have a maximum concentration of 0.1% by weight in homogenous materials for lead, hexavalent chromium, mercury, PBB, PBDE, DBP, BBP, DEHP, DIBP, and 0.01% for cadmium, or qualify for an exemption to these limits as defined in the Annexes of Directive 2011/65/EU (RoHS2). Finished electrical and electronic equipment products will be CE marked as required by Directive 2011/65/EU. Components may not be CE marked. Additionally, the part numbers that TE has identified as EU ELV compliant have a maximum concentration of 0.1% by weight in homogenous materials for lead, hexavalent chromium, and mercury, and 0.01% for cadmium, or qualify for an exemption to these limits as defined in the Annexes of Directive 2000/53/EC (ELV). Regarding the REACH Regulation, the information TE provides on SVHC in articles for this part number is based on the latest European Chemicals Agency (ECHA) 'Guidance on requirements for substances in articles' posted at this URL: <https://echa.europa.eu/guidance-documents/guidance-on-reach>

Compatible Parts



TE Part # 5223957-3
UPM GUIDE MODULE



TE Part # 2187809-1
SW PIR HDR BP, 92OHM, 6X6 OE GR

Also in the Series | **Z-PACK 2mm HM**

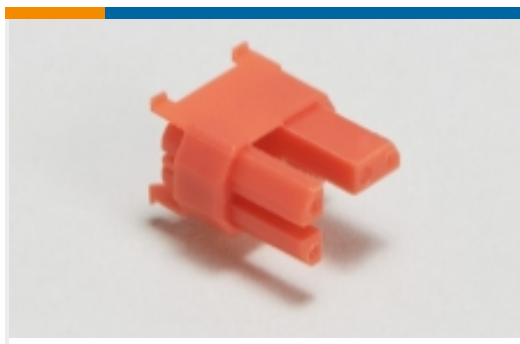

Backplane Coding Keys(60)

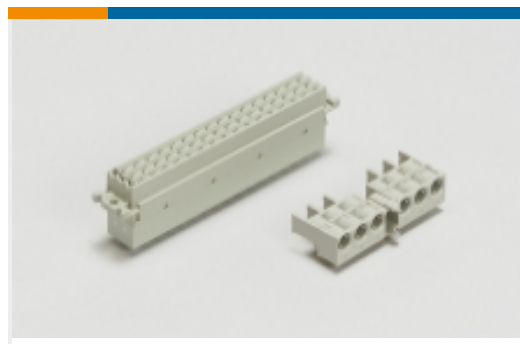

Backplane Connector Housings(4)



Backplane Guide Hardware(37)

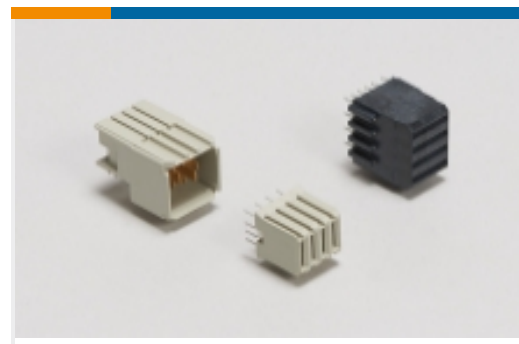

Backplane Power Connectors(6)



Board-to-Board Connector Contacts(2)

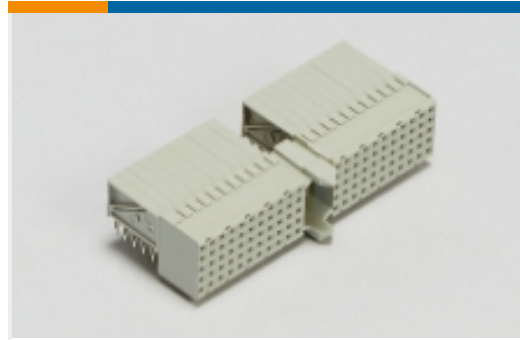

Hard Metric Backplane Connectors (269)

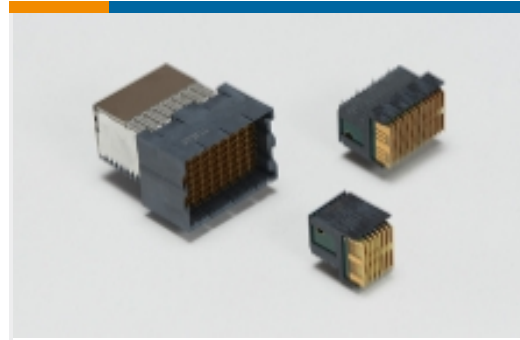

High Speed Backplane Connectors(1)



Insertion & Extraction Tools(2)

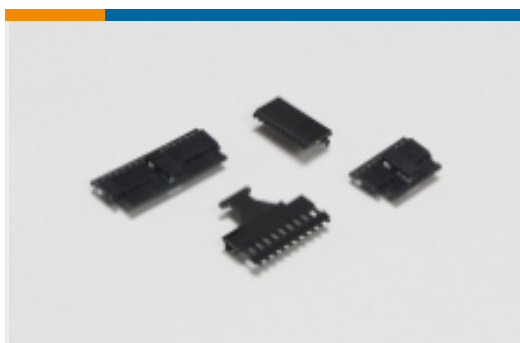

PCB Connector Covers(4)



PCB Connector Shrouds(39)



PCB Ferrules & Shields(19)

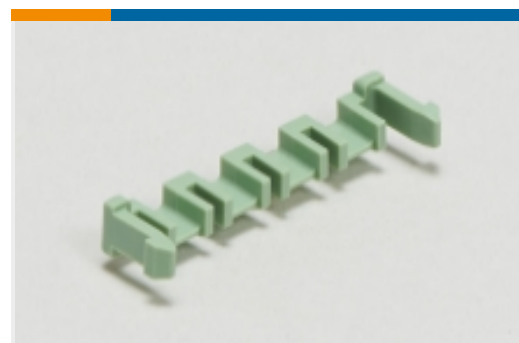

PCB Latches, Locks & Retainers(1)



Rectangular Power Connectors(87)

Customers Also Bought

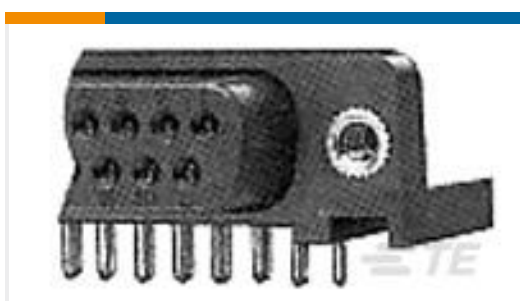

TE Part #5788796-1
09 HTMSFL ASSY RA 318 (IN,BL)



TE Part #5223957-3
UPM GUIDE MODULE



TE Part #1969442-6
EP 2.5 TPA Housing, 6 Pos



TE Part #1969443-6
EP 2.5 TPA Retainer, 6 Pos

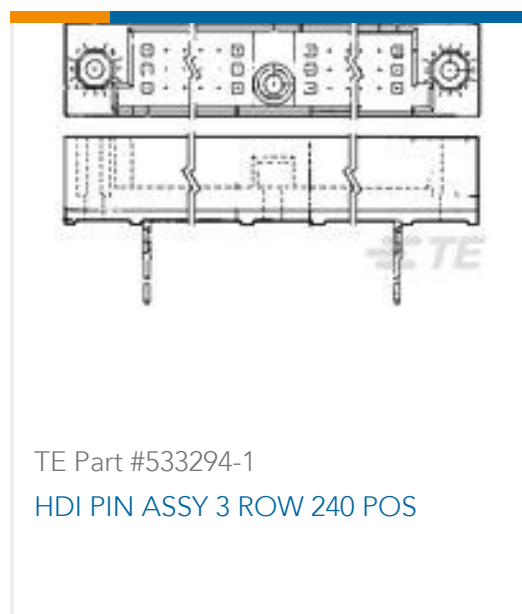

TE Part #533294-1
HDI PIN ASSY 3 ROW 240 POS



TE Part #1355717-1
MQSO,63 Sn rec LL unseal. 0,08-0,22

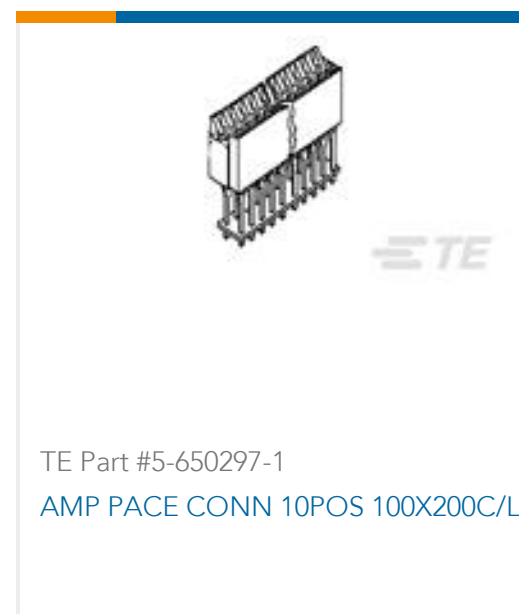

TE Part #5-650297-1
AMP PACE CONN 10POS 100X200C/L



TE Part #5-1474644-0
FSN-22A-4

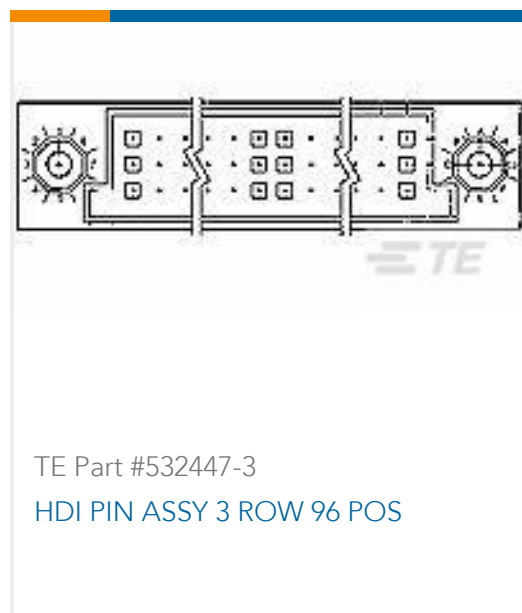

TE Part #532447-3
HDI PIN ASSY 3 ROW 96 POS

Documents

Product Drawings

UPM KEYED GUIDE PIN

English

CAD Files

Customer View Model

[ENG_CVM_CVM_5223985-1_B.2d_dxf.zip](#)

English

3D PDF

3D

Customer View Model

[ENG_CVM_CVM_5223985-1_B.3d_igs.zip](#)

English

Customer View Model

[ENG_CVM_CVM_5223985-1_B.3d_stp.zip](#)

English

By downloading the CAD file I accept and agree to the [Terms and Conditions](#) of use.

Datasheets & Catalog Pages

[POWER_CONNECTORS_CATALOG_SEC01_BOARD_TO_BOARD](#)

English

[2_PIECE_POWER_CONNECTORS_qrg_4-1773458-1](#)

English

Product Specifications

Engineering Report

English



[Product Environmental Compliance](#)

[TE Material Declaration](#)

English